

Turn every lesson into a hands-on adventure

90+ new products, interactive kits, and tools for all ages and topics

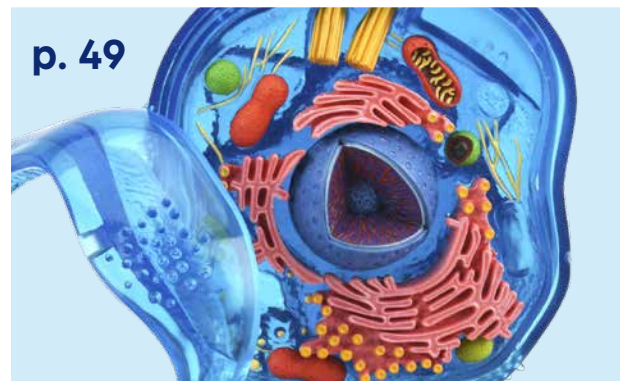

**Your order
could qualify for
special pricing!**

If you need help with a large
order, call 1.800.558.9595.

Planning lessons *just got easier!*

Time-saving tools for every topic

From lab essentials to convenient science kits only available from Nasco Education — the best resources are right here, with even more available online.

Browse the full selection at nascoeducation.com/science

Free lesson plans, webinars, and more

Visit our Teacher Resource Center to find standards-aligned lesson plans, fun experiments to try in your classroom, and guides to help make buying decisions easier.

Get started at resources.nascoeducation.com



Easy ordering & expert support

Ordering is easy — link your school's purchasing system, send an email or fax, or give us a call. We can provide product recommendations, assist you with bids and quotes, ensure you're getting the best pricing, and more!

Call 1.800.558.9595 or email custserv@nascoeducation.com

Need help with a large order or custom science kits?

Our education specialists will hold your hand every step of the way to reduce your workload and your worry!
Call 1.800.558.9595 or email custserv@nascoeducation.com



p. 111

Fizz Wizard and Jammin' Jelly Reaction Kit

What's inside

Biology	4–55	■
Forensic Science	56–63	■
Dissection	64–83	■
Microscopes	84–101	■
Chemistry	102–117	■
Lab Supplies	118–167	■
Earth Science	168–203	■
Space Science	204–209	■
Physical Science	210–257	■
STEM	258–295	■
Furniture	296–303	■

Look for this icon to find more items you can only get at Nasco Education!



Not eligible for discount with contract pricing, sale pricing, or other promotions.

◆ DOT hazardous material

◆ Subject to DOT hazardous material surcharge.

Nasco Education strictly adheres to the U.S. Department of Transportation regulations regarding products classified as hazardous materials. In following these regulations, you may be assessed a special handling surcharge per carton for these items.

Nasco Education Price Change Policy

Due to unforeseen cost increases or operational changes, we reserve the right to change published catalog prices or our shipping policy without notice. Refer to our website for the most current pricing. Some products may be excluded from further discount. Please contact us for a quote.

Certified in a program of toxicological evaluation by a medical expert to contain no materials in sufficient quantities to be toxic or injurious to humans or to cause acute or chronic health problems.

Ships direct from factory. May require extra delivery time. Additional shipping charges apply.

For more information, visit nascoeducation.com/shipping.

Choking hazard label information

- ▲ **CHOKING HAZARD (1)** WARNING: CHOKING HAZARD — Toy contains a small ball. Not for children under 3 yrs.
- ▲ **CHOKING HAZARD (2)** WARNING: CHOKING HAZARD — Children under 8 yrs. can choke or suffocate on uninflated or broken balloons. Adult supervision required. Keep uninflated balloons from children. Discard broken balloons at once.
- ▲ **CHOKING HAZARD (3)** WARNING: CHOKING HAZARD — This toy is a small ball. Not for children under 3 yrs.
- ▲ **CHOKING HAZARD (4)** WARNING: CHOKING HAZARD — Toy contains a small ball. Not for children under 3 yrs.
- ▲ **CHOKING HAZARD (5)** WARNING: CHOKING HAZARD — This toy is a marble. Not for children under 3 yrs.
- ▲ **CHOKING HAZARD (6)** WARNING: CHOKING HAZARD — Toy contains a marble. Not for children under 3 yrs.

90+ NEW PRODUCTS INSIDE!

NEW



ARCADE for micro:bit, p. 274

NEW



Earthquake Shake Table, p. 194

NEW



mRNA Vaccines Education Kit, p. 51

Look for the icon to find more!

Ordering information

nascoeducation.com

1.800.372.1236

1.800.558.9595
Monday – Friday 7 a.m. – 5 p.m. CST

orders@nascoeducation.com

901 Janesville Ave.
Fort Atkinson, WI 53538

Sales tax collected in AL, CA, FL, GA, IL, IN, KS, MA, MD, MI, MN, MO, NJ, NY, OH, PA, SC, TN, TX, UT, WA, WV, and WI. For more details, including sales tax exemption information, visit nascoeducation.com/sales-tax.



Printed on paper sourced from a mill that plants 2.5 million trees annually, is dedicated to sustainable forest management and clean energy, and is certified by the Forest Stewardship Council®. Please recycle.

BIOLOGY

When you help students understand all living organisms — from the smallest bacteria to the largest California redwoods — their curiosity will grow.

Encourage discovery and develop inquiring minds with aquaponics, botany, anatomical models, DNA, cell replicas, and more.

- Aquaponics 4-7
- Insects 8
- Agriculture, Food & Natural Resources 9
- Hydroponics & Gardening 10-15
- Botany 16-22
- Anatomy & Physiology 23-34
- Health Sciences 35-41
- Cells 42-50
- Germ & Diseases 51
- Microbiology 52
- Biotechnology 53-55



AquaSprouts® Complete Garden Kit
Contains everything you need to turn any standard 10-gallon aquarium (not included) into a self-sustaining ecosystem using aquaponics. Includes AquaSprouts® Garden, submersible pump, mechanical timer, expandable bar light, LED grow light, and grow media.
SB52714 — \$250.00

AquaSprouts® Garden Kit
Contains everything listed above, except 10-gallon aquarium and LED grow light.
SB51992 — \$179.95

LED Aquarium Bottom Light Only
SB52236 — \$17.95



For more information on AquaSprouts Garden Kits, go to nascoeducation.com



Aquaponics Education Kit
Six lesson plans (50 minutes each) cover ecosystems, water cycle, fish basics, and more. Includes printed and electronic education booklets, seed packets, 20 g of natural fish food, and 4-oz. bottles of natural water dechlorinator and beneficial bacteria.
SB52672 — \$99.95

BEST SELLER

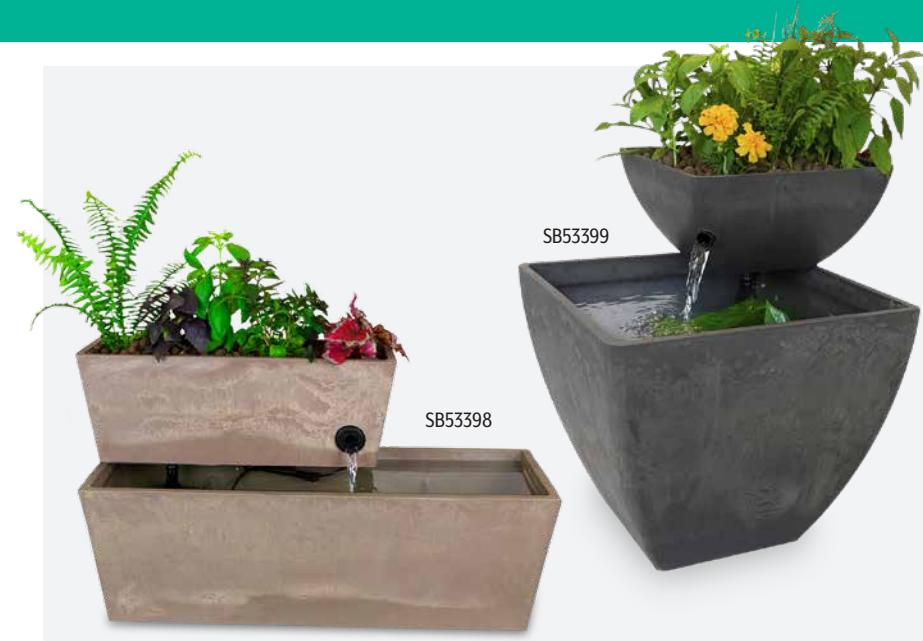

AquaSprouts® Hydroponic and/or Aquaponic Water Fountains
Fountains combine fishkeeping/aquaponic learnings with hydroponic/gardening possibilities to help you build a system that demonstrates the transformation of energy, and brings chemistry, biology, and ecology lessons to life. Freshwater fish waste provides nutrients for the plants and the plants clean the water for the fish.

SB53398 6-Gallon Fountain — \$165.00 SB53399 8-Gallon Fountain — \$175.00



Aquaponics Kit
Acrylic tank, filter sponge, pump, aquarium cover, plant trays with removable covers, watering hoses, plastic net pots, growing medium, and instruction manual. 30" x 12" x 22".
Z49074 — \$605.00



AquaSprouts® Garden - 29 Gallon
Fully functioning aquaponics ecosystem allows you to repurpose a standard 29-gallon aquarium into a self-sustaining growing system. Sustainably sourced birch wood frame.
NE30569 — \$355.00



Countertop Aquaponics System
Space-saving 5-gallon aquarium uses a simple airlift pump. Top is removable.
Z48490 — \$349.95



LaMotte Aquaponics Test Kit
Monitors basic water quality for the aquaculture and hydroponics segments of your system. Reagents, labware, and accessories come in foam-lined carrying case. Perform approximately 50 repetitions per test factor. Test chemistries and comparators are compatible with fresh, brackish, or salt water systems.
* ◆ C34427 — \$345.00

Reagent Refill for Aquaponics Test Kit
◆ C34428 — \$204.95

*EXCLUDED FROM DISCOUNTS

◆ DOT hazardous material ◆ Subject to DOT hazardous material surcharge.



Aquarium Sets – Complete with Tank

Available in either 10- or 20-gallon sizes. Includes deluxe, all-glass aquarium; deluxe hood complete with light strip (lamps not included); and deluxe aquarium starter kit containing an air pump, airline tubing and valves, aerator bar, filter, filter medium, automatic heater, thermometer, fish net, and an aquarium handbook. **CHOKING HAZARD (1).** Not for under 3 yrs.

EXCLUDED FROM DISCOUNTS

Product No.	Capacity	Filtration	Each
SBI6709	10 gallon	Under Gravel Filter	\$220.00
SBI6705	20 gallon	Sponge Filter	\$255.00

Deluxe All-Glass Aquaria

Full-view, all-glass corners; nontoxic, permanently flexible silicone seals; and impact-resistant top and bottom moldings. Extremely popular for school and laboratory use.

Product No.	Capacity	Dimensions	Each
SA04493	10 gallon	20" x 10" x 12"	\$52.95
SA04495	20 gallon	24" x 12" x 16"	\$93.95



S09944



SA04549

Aquarium Gravel

NOTE: We recommend 10 lbs. of sand or gravel per 5 gallons.

Natural Red Flint Gravel. 10 lbs.
S09944 – \$13.95

Rainbow-Colored Aquarium Gravel. 2 lbs. in polyethylene bag.
SA04549 – \$5.25



White Sand

Pure white silica sand for top dressing in aquariums, or may be used for seed. 10 lbs.
S09940 – \$10.15

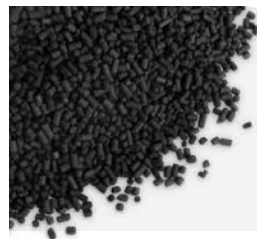

Filter Carbon

Super-activated carbon is the best medium for removing all harmful gases, discolorations, and odors from aquarium water. Granules are uniform in size. Essential to filtration. 5-lb. bag.
SA05525 – \$60.95



Eco-Check™ 5-in-1 Test Strips

One-dip solution for measuring nitrate, nitrite, total alkalinity, total hardness, and pH. Accurate results in seconds. For fresh-water aquariums, ponds, and lakes. 25 strips.
SB39209 – \$14.95

Counter AquaPonics with Grow Light

Add water along with your choice of fish and seed, then watch the ecosystem grow. System uses a space-saving 5-gallon aquarium (included) utilizing a simple airlift pump. Water flows through the filter media along to the plants and filtered water then returns to the fish. Can be used to grow a variety of herbs and lettuces. LED grow light is positioned directly over the grow raft. Height can be easily adjusted as plants grow. Top can be removed for easy cleaning. 16"L x 8"W x 21½"H. **CHOKING HAZARD (1).** Not for under 3 yrs.
Z51477 – \$549.99

Nasco Flex-Tanks and Flex-Covers

Create terrariums, small aquariums, or critter cages. Made from flexible, shatterproof material. Nests to save space; rounded corners provide easy clean up. No-drip covers. Exclusive design forces condensation to remain in the tank.

Product No.	Description	Size	Each
NE30347	½-gal. Flex-Tank Only	5½" x 7" x 3¾"	\$6.25
NE30350	½-gal. Flex-Cover Only	5½" x 7"	\$2.45
NE30348	1-gal. Flex-Tank Only	7" x 7" x 5"	\$7.15
NE30351	1-gal. Flex-Cover Only	7" x 7"	\$3.15
NE30349	1½-gal. Flex-Tank Only	11" x 7" x 5"	\$8.95
NE30352	1½-gal. Flex-Cover Only	10½" x 7"	\$5.25
NE30354	½-gal. Flex-Tank & Cover	5½" x 7" x 3¾"	\$6.95
NE30355	1 gal. Flex-Tank & Cover	7" x 7" x 5"	\$8.95
NE30356	1½ gal. Flex-Tank & Cover	11" x 7" x 5"	\$12.95



NE30356

NE30354



Aquaculture Countertop System

Clear, self-contained ecosystem with biological filtration and plant growth area needs no direct plumbing connections. Requires only one 120V outlet for operation. Recycled 14" water carboy containers, pipe, connectors, filter material, air pump, air stone, and one-plant hydroponic raft. 2 sq. ft. **CHOKING HAZARD (1).**
Z40649 – \$289.95



Desktop Aquarium Kit

Starter kits take up little space. Aquarium, quiet floor filter and cartridge, aquarium light hood, 7-watt incandescent bulb, set-up/care guide, water conditioner, and fish food.
SB47442 – \$44.95



Fish Farm™

5' 4" dia. x 35" polyethylene tank contains 400 gallons of water. Low-space bioreactor; large, silent, oilless air pump; larger self-cleaning biofilter that uses Kaldness media; and additional aeration for better nitrification performance. Electrical components are UL approved, with power consumption at 30 watts. Maintenance takes less than 10 minutes per day and only 2 pails of water (5 gallons each) need to be emptied and replaced. No electricity in the water. **CHOKING HAZARD (1).**
Z29920 – \$5,930.00

EXCLUDED FROM DISCOUNTS

Giant Butterfly Garden®

Watch five caterpillars become painted lady butterflies. Includes collapsible and reusable 18" deluxe habitat, pipette, four life-cycle stages plastic figurines, voucher for 5 caterpillars and nutritious food, and instruction guide. Additional shipping and handling fee required upon redemption. During extremely hot or cold weather, delivery of live larvae may be delayed. Live caterpillars shipped only to continental U.S. and Alaska. **CHOKING HAZARD (1).** Not for under 3 yrs. **SB52857 – \$31.95**

Original Butterfly Garden®. Similar to garden above, but habitat is 11½" and does not include life-cycle stages figurines. Additional shipping and handling fee required upon redemption. **CHOKING HAZARD (1).** Not for under 3 yrs. **SB52856 – \$27.95**

Insect Lore® Butterfly Pavilion Kit with Prepaid Voucher

Over the course of 3 weeks, students observe and learn as 10 tiny caterpillars eat and grow, transform into chrysalides, and then emerge as beautiful painted lady butterflies. Includes prepaid voucher for caterpillars, 2' habitat, STEM journal, and more. U.S. **CHOKING HAZARD (1).** Not for under 3 yrs. **NE30623 – \$57.99**

Portable Animal Habitat – Kritter Keeper

Clear plastic habitat features air vents, flip-top lid for access, and handle for easy transport. For hamsters, gerbils, tropical fish, turtles, frogs, and snakes. 8" x 5". **SB25229 – \$10.95**

Insect Net

Extends from 18"–32" with a 48" conical net mounted on a 14" ring. Nylon. **CHOKING HAZARD (1).** Not for under 3 yrs. **C33048 – \$12.15**



Insect Pop-Up Cage

Simple to set up, easy to clean, and collapsible. One clear plastic side and 3 mesh sides. Access inside through zipper openings on side. **16½" x 16½" x 30" SB46624 – \$10.95**
27" x 27" x 48" SB46623 – \$17.75



Insect Lore® Ladybug Land™ Kit with Prepaid Voucher

Students can observe the ladybug life cycle from larva to adult in this unique habitat with a magnifying lid. Redeem prepaid voucher online for 10 to 15 ladybug larvae. Includes habitat with magnifying lid, water reservoir, STEM journal, and more. **NE30622 – \$37.99**



SB43411



Student Nets

Gr. 7+ Soft ½" mesh grid size, and 20" high-grade knotless pine handle.

Insect. 8" square steel hoop, 6" mesh capturing bag. **SB43411 – \$6.95**

SB43413



Butterfly. 12" steel hoop, 28" mesh capturing bag. **SB43413 – \$14.95**

SB43415



Professional Nets

Gr. 7+ Soft ½" mesh grid size, and 30" extendable handle with quick twist lock.

Insect. 11" square steel hoop, 11" mesh capturing bag. **SB43415 – \$24.95**

SB43416



Butterfly. 12" steel hoop, 28" mesh capturing bag. **SB43416 – \$24.95**



Maxi II Advance Classroom Pack

Incubation and embryology kit for elementary and middle school. Includes lesson plan manual on CD-ROM, Maxi Advance II Incubator, OvaScope, chick brooder, plastic chick enclosure, feeder, and drinker. **C34169 – \$539.99**



Brinsea OvaScope Egg Scope

Watch the live embryo develop inside the egg. Can be fitted with a webcam. Completely blocks out ambient light, slightly magnifies egg's image, and allows viewer to rotate egg smoothly as it is observed. High-output, high-efficiency, LED illumination. No bulbs to replace. No concerns about overheating eggs. For any size egg up to goose eggs. **C29805 – \$89.99**



Incredible Creatures® Life Cycles Set

Use replicas for hands-on sequencing of life cycles. Includes life cycle sets for a frog, monarch butterfly, green bean plant, green sea turtle, chicken, and ladybug. **CHOKING HAZARD (1).** Not for under 3 yrs. **EL11211 – \$59.95**

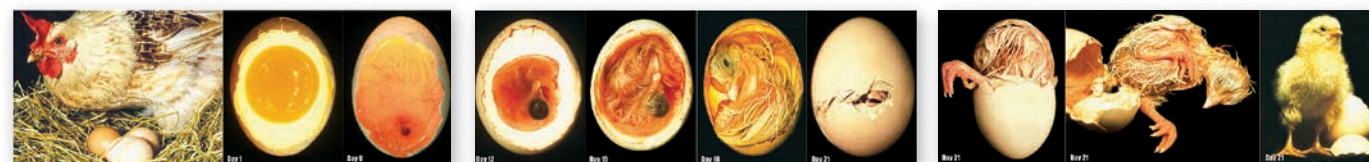

Nasco Chicken Embryology Poster Set

Real pictures show chicken embryo development. May be used separately or joined together. Poster 1 shows days 0–6, poster 2 shows days 12–21, and poster 3 shows day 21. 21" x 7¼" per section. **SB42872 – \$15.99**

Nasco Incubator Kit

Gently warm and hatch up to 42 large chicken eggs or a larger number of smaller eggs. Constructed of thermal-insulated material, the incubator comes with the automatic egg turner and racks, plastic sanitary bottom liner, thermometer, thermostat, and two observation windows. 18" x 18" x 7½". **C17015 – \$134.99**



High-Intensity OvaView Candler

High intensity for darker and mottled eggs (quail, pheasant, etc.). Hold in hand or leave on a surface. High-output, high-efficiency, LED illumination. No bulbs to replace. No worry about overheating eggs. Battery powered; requires rechargeable batteries due to larger power drain. **C29807 – \$57.99**



Chick Life Cycle

Gr. K+ Set of 21 eggs. Plastic. **CHOKING HAZARD (1).** Not for under 3 yrs. **SB45779 – \$37.95**





GROW INDOORS
all year round!



Charcoal

The Rise Garden Hydroponic System

Grow up to 36 veggies, fruits, and greens on each level. Automatically delivers the perfect amount of water for faster growth. App provides directions, reminders, and tips. Each system includes 16 starter plant variety packs, 3 (4-pod) trays per level, 18 net cups per level, and a nursery. 30W LED full-spectrum lights, steel shelves, wood frame, and a self-watering 9-gallon system. Wi-Fi- and voice-enabled.

Single Tier. 39½" H x 16¼" L x 36¼" W

NE30474 Cloud — \$749.00

NE30477 Charcoal — \$749.00

Double Tier. 53" H x 16¼" L x 36¼" W

NE30475 Cloud — \$1,049.00

NE30478 Charcoal — \$1,049.00

Triple Tier. 66¾" H x 16¼" L x 36¼" W

NE30476 Cloud — \$1,349.00

NE30479 Charcoal — \$1,349.00

EXCLUDED FROM DISCOUNTS

Personal Rise Garden Hydroponic System

This award-winning hydroponic system comes with everything you need to grow up to 8 plants in as little as 30 days. Solid-wood frame, full-spectrum LED lights, and a dishwasher-safe, food-grade plastic tray. Includes 8 seed pods, 8 net cups, 1 nursery, and nutrient mixes.

NE30457 — \$349.00

EXCLUDED FROM DISCOUNTS



Seed Pods for Personal Rise Garden

Let students watch a variety of plants grow in your Personal Rise Garden. Thoroughly tested to ensure success. Shelf stable for 1 year.

NE30462 Microgreens Variety 12-Pack — \$22.50

NE30463 Butter Lettuce 4-Pack — \$11.25

NE30464 Mini Sunflower 4-Pack — \$14.00

NE30465 Lavender 4-Pack — \$14.00

EXCLUDED FROM DISCOUNTS



EXCLUDED FROM DISCOUNTS

Rise Gardens Blossom Dry Nutrients

Specially designed for late-stage plant growth and provides minerals for the flowering and seed production phases of plant growth. Buffers pH and may increase speed of growth.

NE30486 30 g — \$10.00

NE30487 150 g — \$16.50



EXCLUDED FROM DISCOUNTS

Rise Gardens Sprout Dry Nutrients

Specially designed for early-stage plant growth and provides minerals for the seedling and vegetative phases. Buffers pH and may increase speed of growth.

NE30488 30 g — \$10.00

NE30489 150 g — \$16.50



EXCLUDED FROM DISCOUNTS

pH Balance Solution for Rise Garden

pH Balance lowering solution helps you keep your pH in the targeted range of 5.8 and allows your plants to uptake their nutrients. 100 ml.

NE30459 — \$17.00

EXCLUDED FROM DISCOUNTS

GrowBox

Tabletop unit has 4 adjustable LED lights and 50 sponge planting sites. Accommodates plants over 3' tall or vining plants. Water capacity: 5.9 gallons. 41" x 28" x 23"-42".

Z50809 — \$733.95



EXCLUDED FROM DISCOUNTS

O₂ Light

Doubles as a tabletop LED reading light with an air refresher fan. Adjustable dual-line water tank accommodates any standard 1", 2½", 3", or 4" flower pot. Fits up to sixteen 2½" pots or sponges. Adjustable position. Water capacity: 0.7 gallons. 22" x 5½" x 21⅞".

Z50814 — \$230.00



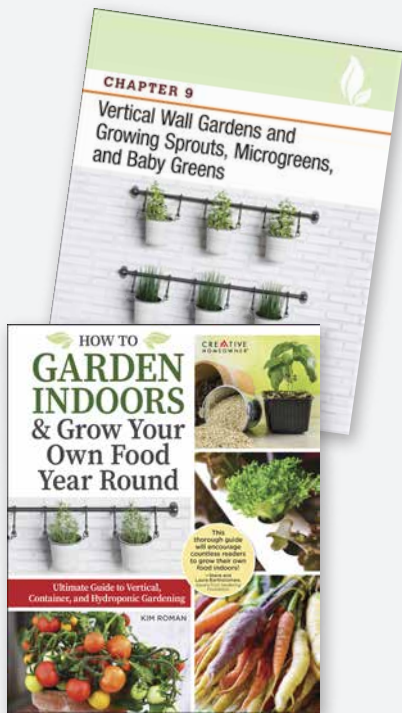

How to Garden Indoors and Grow Your Own Food Year-Round
By Kim Roman

Learn how to grow a garden inside the classroom no matter what time of the year it is. This guide is filled with valuable information and DIY projects on growing vegetables, microgreens, and herbs, as well as information about hydroponic gardening, troubleshooting, and more. 160 pages.
NE40223 – \$25.75

Gronomics® Vertical Garden
Create a garden just about anywhere, indoors or out. The pre-assembled vertical garden only takes up 2 sq. ft. Soil capacity: 4½ cu. ft. Provides over 17' of linear growing space. Includes a drip line irrigation system, making watering easier. Handcrafted of 100% western red cedar. Unfinished. 32" x 9" x 45".
Z47018 – \$367.50

Includes a drip line irrigation system



Gronomics® – Taking Gardening to New Heights

100% Western red cedar. Finished version is coated with a food-contact-safe oil finish; rustic versions are unfinished. Dovetail design slides together in minutes without tools. Assemble, place fabric in elevated bed bottom, add soil of your choice (not included), and plant.

Elevated Garden Bed. Rustic. 48" L x 24" W x 30" H.
Z46649 – \$264.99

Rustic Planter Box. Only available unfinished. 8" x 18" x 19".
Z46650 – \$219.99

Rustic Modular Raised Garden Bed. 48" L x 48" W x 13" H.
Z46651 – \$134.99



Hydroponics Growing Center

Self-contained ebb and flow system features two adjustable timers for water and sunlight, 150-watt grow light, water pump, containment plant tray (27½" x 42" x 8"), 25-gallon nutrient reservoir with lid, submersible pump, air pump, locking cabinet for timers and air pump, air stone, hoses, and 8" net pots. Includes 4" locking casters. 28" x 52" x 78".
Z49096 – \$2,500.00



Investigating Plant Macronutrients Using Hydroponics

Gr. 6–12 In this essential life science activity, the science of hydroponics is used to supply plants with different amounts of key macronutrients and observe how the presence or absence of certain chemicals affects plant growth. The uniquely designed, transparent Lab-Aids® Greenhouse was designed for small, controlled investigations. This easy-to-use apparatus allows you to readily observe plant physiology, particularly root development. Additional experiments can be designed to investigate, observe, and gather data on variables such as aeration and temperature or to compare the speed of seed germination or plant growth. Use by individuals or in groups. Number of simultaneously germinating seeds: 36 total, maximum six per chamber. Complete for six groups. **CHOKING HAZARD (1).** Not for under 3 yrs.
SA01210 – \$165.00



Nasco Grow a Fruit and Vegetable Garden Student Kit

Get your students started on their very own garden. This handy, economical take-home kit includes: 1 pack each of pumpkin, green beans, lettuce and corn seeds; seed starting cartons, soil, planting directions, and activity guide.
SB53412 – \$20.50

Nasco Grow a Decorative Garden Student Kit



Budget friendly take-home or in-class student kit shows students the beauty and the magic of blossoms. Kit includes: a 4-pack of annual flowers and grasses; seed-starting cartons and soil; planting directions and activity guide.
SB53411 – \$20.50



ONLY AT NASCO
EXCLUDED FROM DISCOUNTS



Classic Sienna Raised Garden Bed

Modular raised garden bed with 2" profile. Comes with everything needed except for soil and plants. Tool-free, snap-lock joints make it easy to install — simply slide and snap. Composite boards feature textured wood-grain finish that blends into any environment and will not rot, warp, splinter, or fade. Insulating open-channel boards trap air, providing insulation to your soil. Stacking brackets pivot 270°, allowing endless design options. Beds can be added on to or reconfigured at any time. Shipped directly from our supplier.  

A. 4' x 4' x 5½". 16 sq. ft. of available planting area.
Z51724 — \$99.99



B. 4' x 8' x 5½". 32 sq. ft. of available planting area.
Z51725 — \$149.99

C. 4' x 4' x 11". 2-level raised garden bed with 6 sq. ft. of available planting area.
Z51726 — \$199.99

D. 4' x 12' x 11". Reinforced with bracing boards that prevent frost push-out and divide garden into 3 separate planting areas. Provides depth for growing both underground veggies and tall plants. Provides 48 sq. ft. of planting area.
Z51728 — \$429.99



Raised Garden Box

UV-resistant white vinyl material will not rust, rot, or mold. Simply add soil. 48" x 48" x 15".  
SN36313 — \$98.70





Find out how easy it is to connect your school's e-procurement system on nascoeducation.com



EXCLUDED FROM DISCOUNTS



Elevated Escape Raised Garden Bed

The elevated design and sturdy construction of this raised garden bed makes gardening in small spaces possible. Recycled plastic composite planter boards and aluminum frame. Simple assembly. 24" x 48" x 34½".  
NE30404 — \$299.99



EXCLUDED FROM DISCOUNTS

Skyline Planter Raised Garden Bed

The elevated design and sturdy construction of this raised garden bed makes gardening in small spaces possible. Recycled plastic composite planter boards and aluminum frame. Simple assembly. 24" x 48" x 25".  
NE30405 — \$289.99

BEST SELLER

**NO SPACE?
NO WORRIES!**
Garden even when you don't have your own patch of ground



GreenThumb Classroom Greenhouse

Wire shelves in two tiers allow plenty of room for growth. Clear vinyl cover with large zippered opening fits snugly over metal frame. Assembles in minutes. 36" x 19" x 38". Includes instructions. For indoor or outdoor use.
SB42273 — \$72.95



Greenhouse with EasyFlow™ roll-up side vents delivers quality construction, quick and easy assembly, and best-in-class value

GrowIT® Greenhouse-in-a-Box® EasyFlow™ Greenhouses

Powder-coated 1½" steel frame with steel stabilizers. Translucent, rip-stop cover is waterproof and UV-treated. Easy Slide Cross Rails™ ensure a snug cover fit. Ratchet-Tite™ tensioning provides solid cover anchoring to the frame. Side panels and zippered half-moon end-panel vents provide airflow and temperature control. 1-year warranty against manufacturer defects.  

10' x 10' x 8' Greenhouse
Z47143 — \$469.99

10' x 20' x 8' Greenhouse
Z47142 — \$709.99



TickleMe Plant™
Gr. K+ When touched, the TickleMe Plant™ (Mimosa pudica) quickly closes its leaves and even its branches move down when tickled. These plants also appear to sleep at night by closing up their leaves. Seeds can sprout in a matter of days and within a month the plant will move when tickled. Adult plants can produce pink flowers.

Group Kit. Everything you need for your group (up to 30) to grow these plants from seeds to flowers and back to seeds. Includes 30 seed packets, 30 flower pots (4"), and 30 expanding Wonder Soil® waters. The 38-page TickleMe Plant™ book features over 60 color photos, information about how to care for your plant, over 20 teacher-created science projects, and experiments.
EL10351 – \$89.99

Greenhouse Kit. Includes 2 plant seed packets (each with 10-20 seeds), reusable greenhouse made of recycled plastic, 6 flower pots, 6 coco-peat soil pellets, 10 fun science experiment ideas, and instructions. ⚠ CHOKING HAZARD (1). Not for under 3 yrs.
C29749 – \$23.19

Plant Seed Packet. Includes 10-20 seeds and instructions.
SB43354 – \$7.49



EXCLUDED FROM DISCOUNTS

Plant Light House®
 Snap-together internal frame makes setup and take down simple and fast. No tools needed. Light fixture includes a reflector, dual porcelain fixture, and two 14-watt LED light bulbs. Can grow 64 Fast Plants® to maturity, enough for a class of 32 students. 19" x 18" x 24".
SB41051 – \$214.95



EXCLUDED FROM DISCOUNTS

Perfect for use with Fast Plants® Kits on p. 18

Plant Light Bank
 Comes mostly pre-assembled. No tools required. Uses twelve 18-watt spiral compact fluorescent bulbs (included). Accommodates up to three Wisconsin Fast Plants® classroom kits. 53½" x 24½" x 28".
SB48915 – \$444.95



Vacuum-Formed Square Pots
 Special design allows trays to be filled from edge to edge in seconds, promoting more efficient use of costly soil mixes. Black.
4½" with Tray. Set of 15. 4½" x 3¾".
SB42878 – \$11.95
2½" with Tray. Set of 32. 2½" x 3½".
SB42879 – \$12.95
2½" without Tray. Set of 32. 2½" x 3½".
SB42876 – \$9.25



Sprout & Grow™ Window
 Watch bean and pea seeds sprout and roots develop and grow in nutrient-enriched soil through large window. Step-by-step guide has instructions, suggested activities, and journal pages to fill in observations. ⚠ CHOKING HAZARD (1). Not for under 3 yrs.
SB36694 – \$28.95



Set of 10 Crystal Clay® Kits
Gr. 5+ Just add water and watch soil grow 100 times its size in 30 minutes. Seeds are guaranteed to sprout. 10 each of growing tubes, Crystal Clay® gel, seed packets (miniature pumpkin, blue morning glory, and sunflower), paper tube stands with plant growth life cycle, and instructions.
SB42635 – \$31.95



All-In-One Greenhouse
 No soil needed. Just add water, pellets, and seeds. Use for starting seeds or cuttings indoors. Pack of 25 Jiffy-7® Peat Pellets, sturdy base tray (reusable), and a clear greenhouse dome.
SB28559 – \$13.50



Professional Jiffy® Greenhouse
 Easy-to-use greenhouse kit provides professional results for starting seeds or cuttings. Kit includes 11" x 22" tray/dome and 72 Jiffy-7® Peat Pellets. It is just a small, thin, easily stored wafer enclosed in a fine plastic netting. Add water and it expands to its ultimate size of 1¼" in diameter by 2½" in height, all neatly enclosed in the plastic net.
SB31095 – \$17.75



Easy Grow Greenhouse®
 Seeds sprout faster and root cuttings start quicker, too. Dome holds moisture and warmth inside. 72 pop-out gro-cells in 11" x 22" rugged plastic tray.
SB11127 – \$11.25

Seed assortments and seed germination paper found on p. 18

Plant Food – Nutrient Deficiency in Plants
 Examine the effects of nutrient deficiency on plants by depriving each plant of 1 of 7 specific vital nutrients and observing effects on growth. Enough material for three complete setups.
C31019 – \$71.95



Wisconsin Fast Plants® Kits

Contains everything you need to complete the activities including seeds, an automatic watering system that provides enough water for 3–4 days, planting units, pollination materials, plant stakes, pot labels, fertilizer, and growing instructions booklet. Many kits are reusable. Kits require 24-hour cool, white fluorescent light which can be provided with Plant Light House® (SB41051, see p. 16) for a single classroom or Light Bank (SB48915, see p. 17) for up to three classroom kits. For up to 32 students.

Kit Refill. Contains seeds, pollination materials, stakes, labels, chemicals, fertilizer, and instructions. Cannot ship outside the continental U.S.
SB41047 – \$89.95

Elementary Exploration of Plant Life Cycles. Grow plants through an entire life cycle in only 40 days. Cannot ship outside the continental U.S.
SB41048 – \$142.95

Wisconsin Fast Plants® Standard Seed. Produce flowers in 13–17 days. Cannot ship outside the continental U.S.
SB41049 Pack of 50 – **\$25.50**
SB41050 Pack of 200 – **\$63.95**



Seed Starting Kit
Includes seed assortment, pack of 50 Jiffy® peat pots, 50 plant tags, 16 qts. of Jiffy-Mix® seed starting soil, and osmocote plant food.
SB42710 – \$59.95



Seed Assortment
Includes field corn, rye grass, lima bean, dwarf marigold, green arrow pea, radish, grey strip sunflower, and blue lake green bean.
SB42711 – \$19.50



Jiffy® Seed Starting Soil/Peat Pots & Pellets
Seed Starting Soil. Sterile, fertilized growing media.
SB30115 8 qts. – **\$9.95**
S08460 16 qts. – **\$18.95**
Peat Pots. Case of 1,404. Roots grow right through the bottom and sidewalls; plant the whole pot. 3" dia.
SA08086 – \$273.95
Peat Pellets. Add water and it expands to its ultimate size of 1¾" dia. x 2½"; enclosed in the plastic net.
SA07926 Case of 1,000 – **\$223.95**
SA00407 Packet of 25 – **\$6.25**



Quads Reusable Planters
Four-cell foam planters can be adapted to individual or group work. Easy to store. Set of 16.
SB47153 – \$18.50



Seed Germination Paper
Tan creped towel used for seed germination. 100 sheets, 10" x 15".
SB39211 – \$36.95



Plant Labels
Pack of 50. ½" x 4".
SB41071 – \$6.25



Nasco E-Z Spray Bottle
Adjustable spray pattern. Pistol grip handle and bottle. Pint.
C07664 – \$2.85

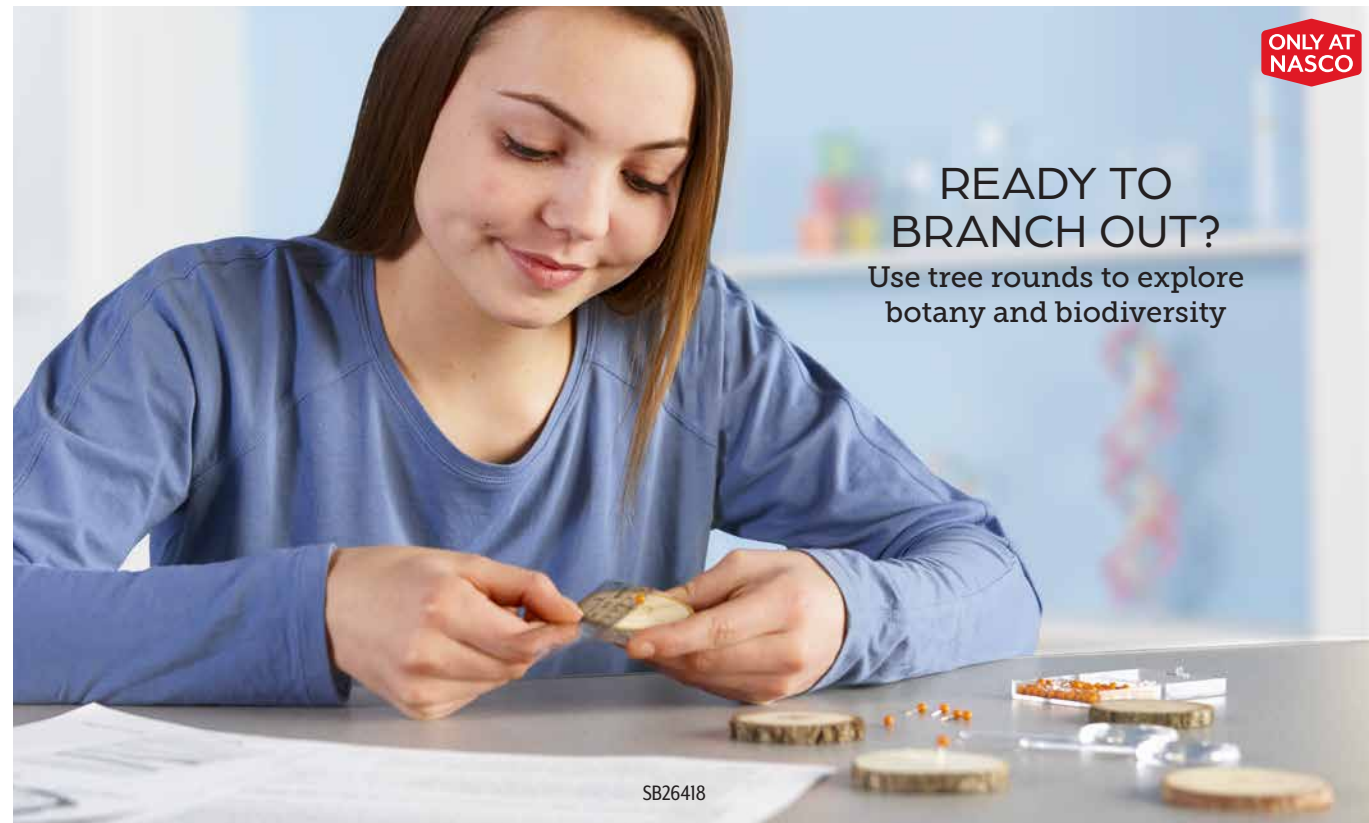

ONLY AT NASCO

READY TO BRANCH OUT?
Use tree rounds to explore botany and biodiversity

SB26418

Nasco Biodiversity Tree Study Kit

Students will have the experience of working with six different varieties of tree species from a temperate climate region of North America. Information on the biodiversity of hardwood and softwood trees is provided, with directions for students to engage in hands-on inquiry exercises. Similar internal tree structures will be compared, while the variation between species will also be identified. Illustrations and directions are included in the study guides. Kit includes 6 assorted tree rounds (2 softwood and 4 hardwood species), 15 hand magnifiers, colored marking pins, 15 metric rulers, 15 reproducible student study guides, reproducible student activity sheets, teacher study guide, and a tree round information sheet to assist with tree identification.
SB26418 – \$54.95

Nasco Tree Growth Study Kit

Gr. 6–10 Designed to show students the variations of different tree species. Students will learn how seasonal growth changes the appearance of layers of growth within the tree, and will find that spring wood and summer wood combine to produce annual rings. They will also learn how to estimate tree age by examining the annual rings of three different tree rounds. Includes 3 tree rounds (1 each of oak, pine, and walnut), a hand magnifier, colored marking pins, a metric ruler, 6 reproducible student guides, teacher guide, reproducible activity sheets, and *Trees: A Golden Guide* book.
SB22657 – \$34.95



Dendrochronology: Tree Ring Dating Kit
Gr. 6+ Learn about the effects of climate on living things while studying the age and history of trees in 30 simulated, reusable tree cores. For 30 students. Takes 50 minutes to complete. **CHOKING HAZARD (I).** Not for under 3 yrs.
SB50433 – \$79.95



Tree Cookies
Explores the life cycle of trees, see the variations in tree species, estimate a tree's age, and learn about factors that affect tree growth. Approximately 2" – 4" dia.
Set 1. Three tree cookies (1 each of oak, pine, and walnut).
SB25029 – \$8.25
Set 2. Six tree cookies (1 each of red oak, pine, walnut, basswood, ash, and red pine).
SB26464 – \$15.00



NewPath Learning® Photosynthesis and Cellular Respiration Curriculum Learning Module
Gr. 6–10 Blend of technology-based instructions, interactive print resources, and game-based learning. Covers cell energy, photosynthesis, and cellular respiration.
SB52105 – \$124.95



Explore parts of a flower in 3D

Foam Flower Model
Resilient, nontoxic EVA foam and removable pieces for hands-on use with students of all ages. Detailed teacher's guide includes background information, reproducible worksheets, cross-curricular extension activities, assessment ideas, and more. **CHOKING HAZARD (I).** Not for under 3 yrs.
SB31406 — \$85.95



Dicot Flower Model
Enlarged approximately 8 times. Disassemble to view pollen grains. Important structures are numbered and correspond to identification key. 17 1/16" x 15 1/16" x 12".
SB50602 — \$135.95

BEST SELLER



Photosynthesis and Respiration Chamber
Monitor the cycle of photosynthesis and respiration of plants using NeuLog O₂, CO₂, and light sensors. Gallon clear glass bottle with cap, rubber stopper size 00, and rubber stoppers size 7. (Plants and sensors not included.)
SB51966 — \$39.00
NeuLog Logger Sensors. See nascoeducation.com for complete descriptions.
SB51188 CO₂ — \$325.00 **SB50677 Oxygen — \$300.00**

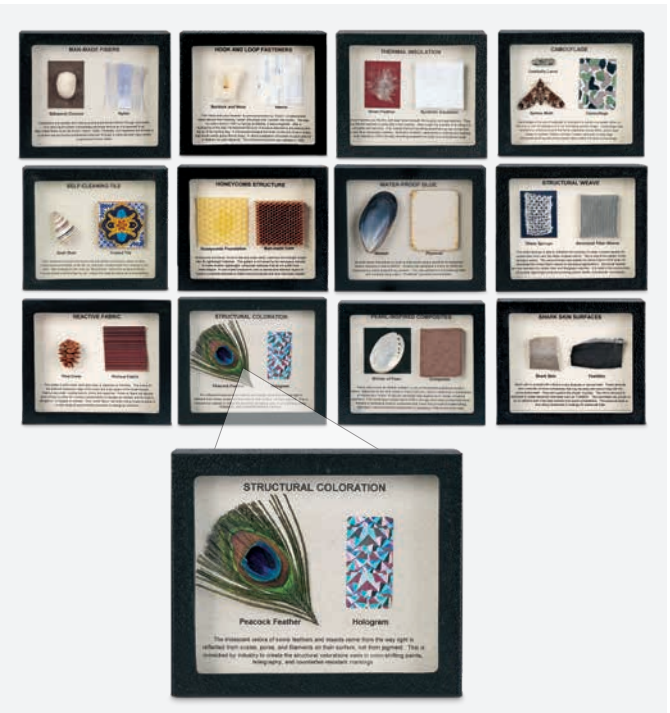

Biomimicry: Technology Inspired by Nature
Displays show an innovation and the element of nature it resembles, along with an explanation of the subject. Innovations include camouflage, hook-and-loop fasteners, man-made fibers, and more. Set of 12; 6" x 5" each.
SB50607 — \$290.00



Photosynthesis and Cellular Respiration Kit
An investigation into the reactions of photosynthesis and cellular respiration using a series of images and statements which are then discussed relative to ecosystems and the carbon cycle. **CHOKING HAZARD (I).** Not for under 3 yrs.
C33050 — \$110.95

Acid Rain and the Environment: Acidity and Plant Growth Kit
The problem of acid rain is quite often associated with its effects on aquatic systems. Unfortunately, acid rain can also have devastating effects on terrestrial environments as well. In this activity, examine the detrimental effects of acidic conditions on plants. The plants will be grown under normal soil conditions, mildly acidic soil conditions, and very acidic soil conditions. Through physical observation, determine if the acidity has any impact on the growth of the plant. Contains enough materials for 15 groups.
C31020 — \$79.95

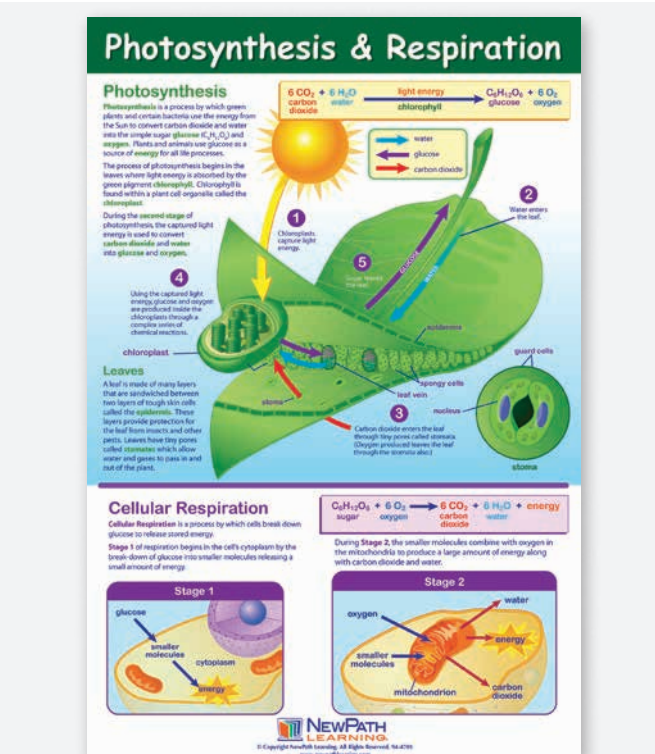

NewPath Learning® Photosynthesis & Respiration Poster
Shows steps of photosynthesis and stages of respiration. 23" x 35". Laminated.
SB47610 — \$20.95



Photosynthesis, Plants, and Food
Gr. 6+ Teams use an atom model to build carbon dioxide and water molecules, then "react" them to form sugar and oxygen molecules. Students also read about plants' role as producers and are introduced to chloroplasts. For 32 students. **CHOKING HAZARD (I).** Not for under 3 yrs.
SB46818 — \$109.95

Plant Kingdom Survey Set

Collection of 12, 6" x 5" display mounts, each containing labeled specimens. Fungi, algae, lichens, and true plants are represented with 47 specimens. Contains algae, lichens, fungi, liverworts, mosses, seedless vascular plants, gymnosperms, monocot angiosperm, dicot angiosperms, seed types, leaf venation, and parasites and epiphytes. On occasion, similar specimens may be substituted due to availability. **SB37295 – \$340.00**



Leaves and Seeds of Common Trees Identification Mounts

Each species is represented by both leaves and seeds. Leaves and twigs are pressed. Fruits have been freeze-dried. Each 5" x 8" mount is labeled on back with common and scientific names, family, leaf arrangement, leaf type, tree size, fruit type, natural habitat, and a range map for the U.S. Includes 16 mounts in 6" x 15" flip bin. **SB37259 – \$94.95**



Plant Press

Solid oak frames with brass-plated rivets and cotton web straps with sliding buckles. 12 driers and ventilators. 12" x 18". **SA02726 – \$89.95**



Absorption Paper

Thick, absorbent, non-fuzzy, white blotting paper. Pack of 100, 12" x 18". **SA04460 – \$119.95**



Plant Mounting Sheets

Cardboard herbarium sheets. Printed legend in lower right-hand corner. No rag content. 11½" x 16½", 140-lb. weight paper. Pack of 25. **C09647 – \$19.95**



Nature Print® Paper

Undergoes chemical change when exposed to sunlight. Images appear in minutes. Select specimens you wish to print, arrange them on paper, and expose to sunlight for 2–3 minutes. Soak in water for a minute, then dry. Images will sharpen during drying. Pack of 30, 5" x 7". **5500210 – \$12.15**



Broken Bones X-Rays

15 real X-rays reveal a detailed look at common breaks to a variety of human bones. Includes guide. **SB43367 – \$36.20**



American 3B Disarticulated Human Skeleton

Natural human skeleton reproduction made of unbreakable plastic that does not deteriorate with age. Each bone is cast individually in natural color with all details of anatomy represented. All bones, except skull (with detachable top and mandible), one foot, and one hand, are disarticulated. **SB13487 – \$627.40**

Fixed Bones X-Rays

Authentic X-ray images show the hardware used to fix a broken bone. Additional images of the fractures correspond to the X-rays of the repairs. 14 X-rays, 14 broken bone images on card stock, and guide. **EL14149 – \$24.00**



True-to-Life Human X-Rays

Arrange 18 X-ray pieces together to reproduce entire 5' skeleton. Teacher guide includes reproducible artwork and information on radiography. **SB40317 – \$41.20**

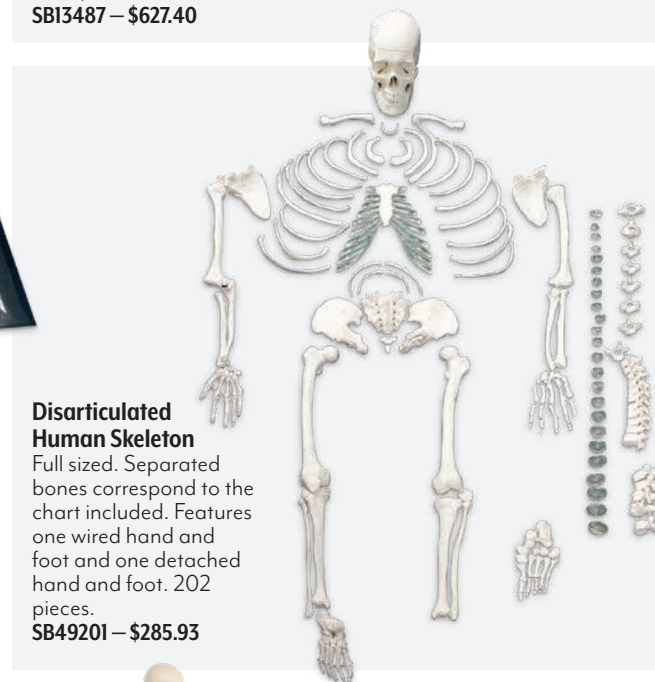

Disarticulated Human Skeleton

Full sized. Separated bones correspond to the chart included. Features one wired hand and foot and one detached hand and foot. 202 pieces. **SB49201 – \$285.93**

Light Cube

Portable, rechargeable cube strobes, flashes, and changes color with the touch of a button. Stand or kneel at the cube indoors or out. Sturdy construction and long-lasting LED light source. Easy-to-clean surface. Includes power source, remote control, and teacher guide. 16" x 16" x 16". **SN35734 – \$323.00**

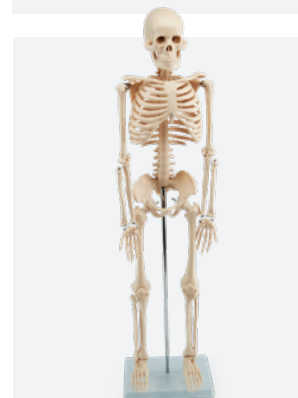

34" Skeleton Model

Gr. 7+ Smaller size model allows skeleton to be included in classroom at half the expense and size. Includes stand and key. **SB48602 – \$68.01**



Miniature Human Skeleton Model

Features movable joints, an articulated mandible, and removable skull cap. Arms and legs are attached by threaded studs and nuts, allowing you to adjust their flexibility. Made of washable polymer material. Includes rod mount and plastic base. 17" tall (17.5" when mounted on rod). **NE40636 – \$28.49**

BEST SELLER



Height: 5'7"

Human Skeleton
Made from unbreakable plastic cast from an actual specimen. Hand assembled and finished. 200 accurately weighted bones of an actual adult human, easily removable limbs, individually spaced and molded teeth, and fully articulated hands and feet. Pelvic mounted on 4' roller stand. Full height with stand: 5' 7". Poster included. **SB02011 – \$391.18**



Height: 5'6"

Human Muscular Skeleton
Shows all skeleton parts in great detail. Articulated main joints. Upper and lower limbs remove easily. Detachable calvarium, skull, jaw, arms, and legs. Left side shows points of origin (red) and points of insertion (blue) of the muscles. Includes transparent dust cover. 5 ft. 6" H. **LA00100 – \$808.85**



Height: 5'7"

Full-Size Flexible Skeleton
Spine bends to mimic natural human movement. Arms and legs are removable. All movable parts are joined by connectors that allow movement around the joint. Hands and feet are wire mounted. Skull has movable jaw, removable skullcap, suture lines, and full dentition. Bones are cast individually from natural-colored plastic with anatomical detail. Comes pelvic mounted on roller base and with a diagram. **SB51062 – \$572.05**
Half-Size Flexible Skeleton with Muscle Insertions. Full height with stand is 33". **SB52181 – \$143.01**
Full-Size Flexible Skeleton with Muscle Insertions. Full height with stand is 67". **SB51061 – \$629.20**



Height: 5'5"

Full-Size Human Skeleton with Muscles and Ligaments
Full-size model is mounted upright and carefully casted in durable molding with natural color plastic. Arms and legs are joined by connectors and can be moved to demonstrate natural movement around the joints. Both the arms and the legs are removable for further study. The skull features a moveable jaw, suture lines, and three removable teeth. Includes a roller base and a diagram. 67"H. **SB49572 – \$659.75**

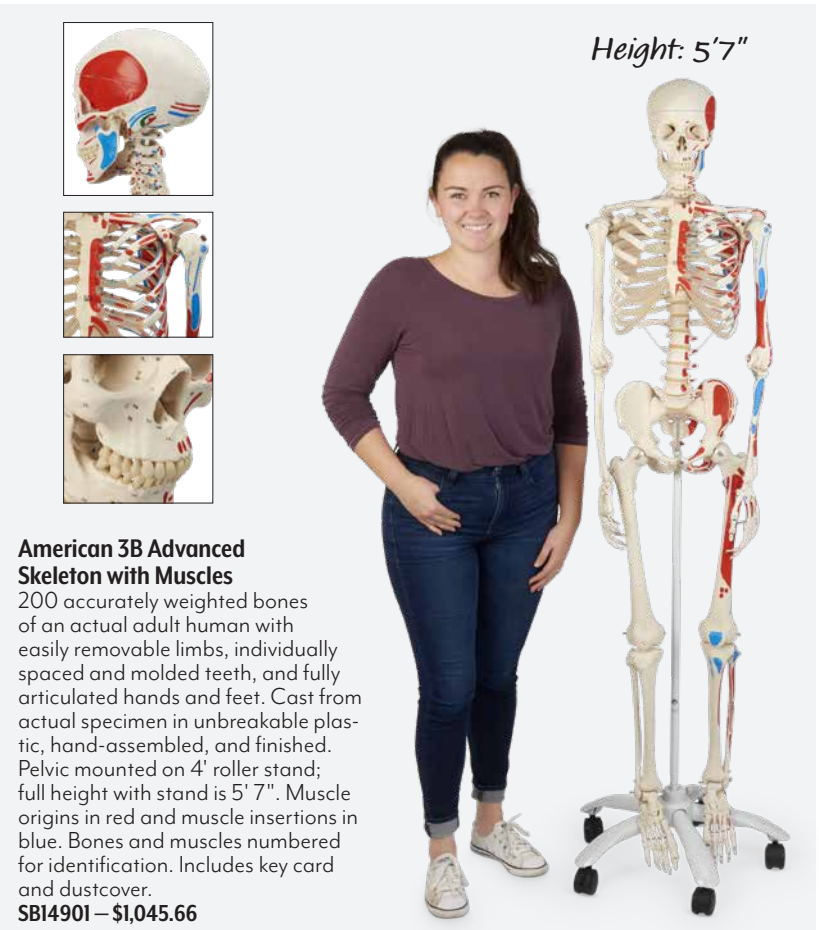

Height: 5'7"

American 3B Advanced Skeleton with Muscles
200 accurately weighted bones of an actual adult human with easily removable limbs, individually spaced and molded teeth, and fully articulated hands and feet. Cast from actual specimen in unbreakable plastic, hand-assembled, and finished. Pelvic mounted on 4' roller stand; full height with stand is 5' 7". Muscle origins in red and muscle insertions in blue. Bones and muscles numbered for identification. Includes key card and dustcover. **SB14901 – \$1,045.66**



Height: 2'9 1/2"

Half-Size Skeleton
Wired for natural movement. Removable skull with calvaria cut. Miniature springs hold mandible in place. Tiny screws hold arms and legs in position so you can bend extremities in all directions. Although basic appearance and functional value of skeleton is excellent, there may be flaws in the construction. Plastic on heavy metal stand with stainless steel hardware. 33 1/2". **SB22564 – \$101.50**



EXCLUDED FROM DISCOUNTS

Skeleton Dustcover - Black
Protect your investment with this heavy-duty protective cover. Suitable for all full-size skeletons and stand versions. Transparent window. **SB45480 – \$86.70**



Skeleton Dustcover - Blue
Protects full-size skeletons (both hanging and pelvic mounted). Zippered. Heavy-duty fabric with transparent window. **SB51049 – \$28.62**

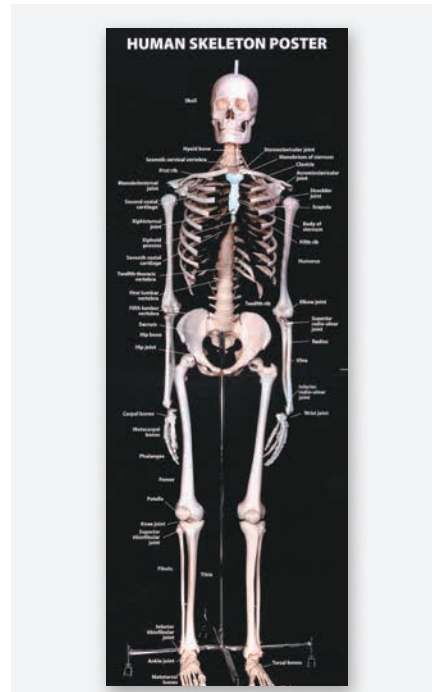

Human Skeleton Poster
Front view with major bones and joints identified. Height: 4'6". Comes in storage tube. **SB28462 – \$24.40**



Mounted Hand Model
Fingers are flexible enough to demonstrate movement. Mounted on plastic base. **SB49825 – \$49.23**

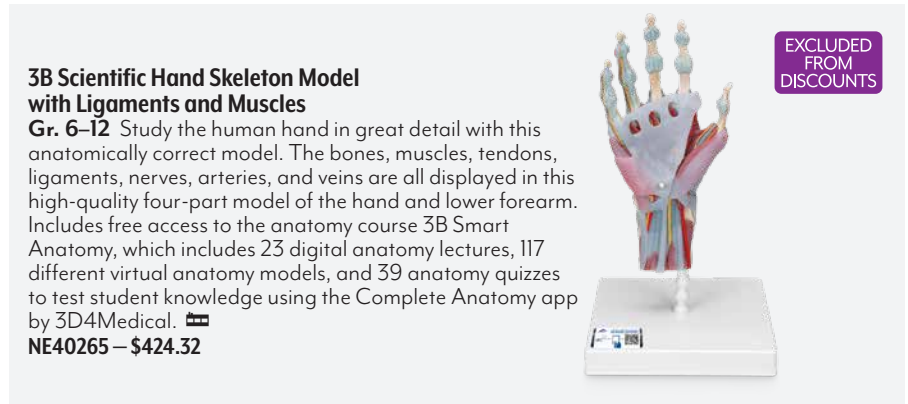

EXCLUDED FROM DISCOUNTS

3B Scientific Hand Skeleton Model with Ligaments and Muscles
Gr. 6–12 Study the human hand in great detail with this anatomically correct model. The bones, muscles, tendons, ligaments, nerves, arteries, and veins are all displayed in this high-quality four-part model of the hand and lower forearm. Includes free access to the anatomy course 3B Smart Anatomy, which includes 23 digital anatomy lectures, 117 different virtual anatomy models, and 39 anatomy quizzes to test student knowledge using the Complete Anatomy app by 3D4Medical. **NE40265 – \$424.32**



Foot/Ankle Model
High-quality, solid cast model of foot bones. 9" x 3 1/4" x 2 1/2". Base and education card included. **SB35472 – \$130.56**



EXCLUDED FROM DISCOUNTS

3B Scientific Foot Skeleton Model with Ligaments and Muscles
Gr. 6–12 Examine the human foot in great detail with this anatomically correct model. The bones, muscles, tendons, ligaments, nerves, arteries, and veins are on full display in this six-part model of the foot and ankle. The model includes free access to the anatomy course 3B Smart Anatomy, which includes 23 digital anatomy lectures, 117 different virtual anatomy models, and 39 anatomy quizzes to test student knowledge using the Complete Anatomy app by 3D4Medical. **NE40266 – \$406.98**



3B Scientific Flexible Human Spine Model Gr. 6–12 Teach the anatomy of the human vertebral column with this fully flexible spine model with hands-on demonstrations. Features full male pelvis and occipital plate, fully flexible mounting in spine, prolapsed disc, spinal nerve, and cervical vertebral artery. Includes free access to the anatomy course 3B Smart Anatomy, which includes 23 digital anatomy lectures, 117 different virtual anatomy models, and 39 anatomy quizzes to test student knowledge using the Complete Anatomy app by 3D4Medical. **NE40271 – \$166.26**



3B Scientific Functional Shoulder Joint Life-size, movable model on stand illustrates the mechanics of the shoulder joint. Consists of shoulder blade, collar bone, portion of humerus, and joint ligaments. 6¼" x 4¾" x 7¾". **SB41402 – \$122.40**



3B Scientific Functional Knee Joint Model Life-size, movable model on stand provides a graphic demonstration of the anatomy and mechanics of the knee joint. Consists of portion of femur, tibia, and fibula, plus meniscus, patella with quadriceps tendon, and joint ligaments. 6½" x 4¾" x 13½". **SB41404 – \$122.40**



Flexible Vertebral Column with Femur Heads, Muscle Insertions, and Removable Sacral Chest Life-size vertebral column shows 5 different sections of the spinal column, including prolapsed L3-L4 discs. Includes pelvis and removable femur heads. Represents the vertebral arteries, spinal nerve branches, and intervertebral discs. Muscles origins (red) and insertions (blue) are depicted on the left side. Comes with a hanging stand and labeled diagram. **LA00102 – \$219.00**



Mini-Muscle Joint Set Set of 4 reduced-size (approximately 50% of regular models) joint models of the hip, elbow, shoulder, and knee. Card size: 8¼" x 6¼". **SB47324 – \$149.95**



Spine Model Molded from PVC plastic. Hand-painted to show cervical, thoracic, and lumbar regions and sacrum/coccyx. Mounts on metal rod with plastic stand. Laminated color guide with 66 labeled structures (structure names on one side; numbers on other). Includes 10-page reproducible study guide. 14" x 5¼" x 4". **SB52565 – \$132.76**



Muscles of the Human Arm Model (7-Part) Life-size model shows the anatomical structure of the arm with superficial and deeper muscles, vascular structures, nerves, and ligaments. Removable parts. Mounted on base with stand. 29⅞" x 7⅞" x 4¾". **LA00129 – \$516.00**



Leg Muscle (13-Part) This 13-part model shows, in great detail, the anatomical structure of the leg. The life-size model is complete with superficial and deeper muscles, vascular structures, nerves, and ligaments. Removable parts. Mounted on base with stand. 43¼" x 7½" x 5¾". **LA00131 – \$961.00**



See-Through Sally™ Human Anatomy Display Set of 12 spiral-bound anatomy charts (22" x 36") mounted on metal frame and 66" floor stand. Charts begin with body's outer layer and continue through various organ systems. Each page has a full-view image with all organs numbered sequentially, a number key, and highlights for anatomical features of each system. **SB51340 – \$375.00**



EXCLUDED FROM DISCOUNTS



Skin Model Enlarged 70 times. Individual layers of skin are clearly differentiated. Anatomical structures such as hair follicles, sweat glands, and receptors are shown in detail. 3-D model mounted on 10½" x 7½" board. 11½" x 8½" x 10". **SB49202 – \$114.39**

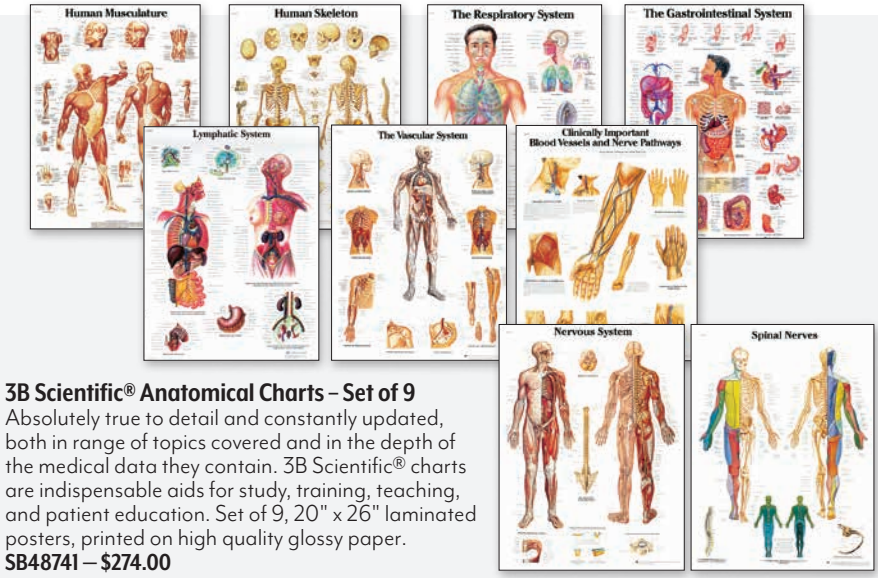

3B Scientific® Anatomical Charts – Set of 9 Absolutely true to detail and constantly updated, both in range of topics covered and in the depth of the medical data they contain. 3B Scientific® charts are indispensable aids for study, training, teaching, and patient education. Set of 9, 20" x 26" laminated posters, printed on high quality glossy paper. **SB48741 – \$274.00**



3B Scientific Microscopic Skin, Hair, & Nail Model Gr. 6–12 Use this high-quality model to show students the microscopic structure of human skin in great detail. Includes a nail section on the base, showing the nail plate, nail bed, and the nail root. The model includes free access to the anatomy course 3B Smart Anatomy, which includes 23 digital anatomy lectures, 117 different virtual anatomy models, and 39 anatomy quizzes to test student knowledge using the Complete Anatomy app by 3D4Medical. **NE40267 – \$94.86**



Set of 10 posters

5 Senses Poster Set Posters with 3-D illustrations, detailed cutaways, and labeled sense organs and their parts. Poster topics: sight, taste, touch, smell, hearing, hearing loss, eye disorders, seeing color and light, nearsightedness and farsightedness, and overview of the 5 senses. Laminated. Set of 10; 17" x 22". **SB35256 – \$175.10**

NEW

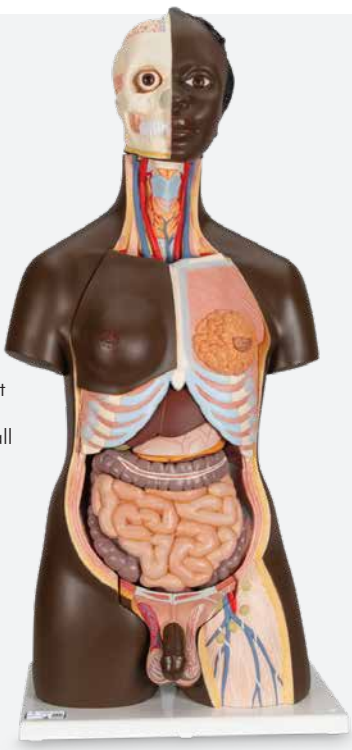

3B Scientific Deluxe Torso Model - Dual Sex - African

With the deluxe torso, you can offer detailed instruction in human anatomy. Includes 3B Torso Guide. Removable parts and organs: 3-part head, 2-part stomach, female chest wall, 2 lungs, 2-part heart, liver with gall bladder, 4-part intestinal tract, front half of kidney, 4-part male genital insert, 3-part female genital insert with fetus. **NE40364 – \$1,468.80**

3B Scientific Deluxe Dual Gender Torso (24-Part)

Removable parts and organs: three-part head (removable), two-part stomach, female chest wall, two lungs, two-part heart, liver with gall bladder, four-part intestinal tract, front half of kidney, four-part male genital insert, and three-part female genital insert with fetus. 34" x 15" x 10". **SB25326 – \$1,568.00**



BEST SELLER

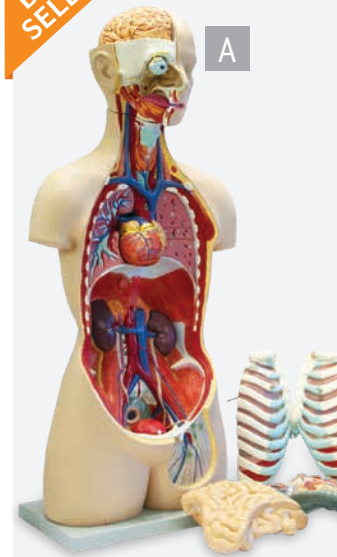

A. Genderless Human Torso with Open Back (17-Part)

Head is opened, exposing half of the brain. Dissected neck shows muscular, glandular, vascular, and neural structures. Thorax and abdomen are removable. Back is opened and dissected, showing the vertebral column, spinal cord, and nerve endings. Removable parts: torso, cerebrum, cerebellum, left and right lung with ribs, heart (2 parts), liver, stomach (2 parts), half kidney, half bladder, seventh thoracic vertebrae, intestine, colon with pancreas, transverse colon, and cecum cover. Key card. 9" x 13" x 34". **SB48432 – \$669.29**

BEST SELLER

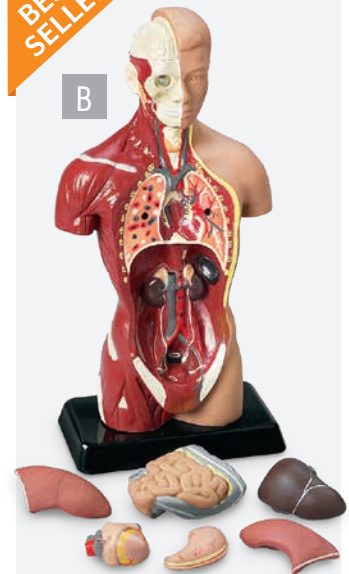

B. Genderless Human Torso (6-Part)

Compact plastic model displays the respiratory, circulatory, digestive, nervous, and urinary systems, as well as musculature. Easy removal of the lungs, heart, liver, stomach, and intestines. Full-color instruction manual. 10". **SB25196 – \$65.92**

C. Genderless Human Torso (12-Part)

Numbered or lettered anatomical features correspond to key card. Torso, head (2 parts), brain half, 2 lungs, heart (2 parts), stomach, liver, intestines, and cecum cover. Mounted on plastic base. 20" x 8" x 3 1/4". **SB25198 – \$192.34**

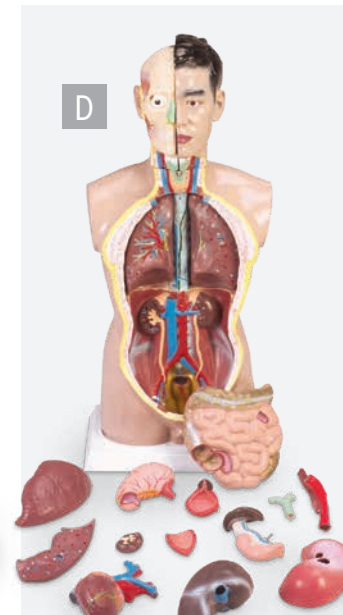

D. Human Torso (20-Part)

Head is removable; half of brain is removable to show a sagittal section. Heart, a portion of each lung, liver, stomach, and pancreas (including a portion of the duodenum) can be removed. Right kidney is separate and sectioned to show internal anatomy. Intestinal mass comes out in one piece. Plastic. Mounted on plastic base. 14 9/16" x 9 7/8" x 33 1/2". **SB25195 – \$274.04**

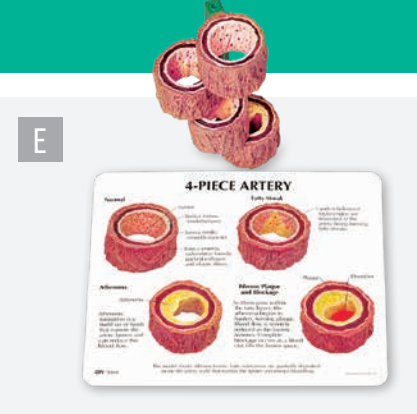

E

Includes 7 charts



The Human Body Learning Charts Combo Pack
Seven charts include nervous system; skeletal system; reproductive, endocrine, and excretory systems; respiratory system; cardiovascular system; muscular system; and digestive system. 17" x 22" each. **SB42082 – \$27.95**

BEST SELLER



ONLY AT NASCO

EXCLUDED FROM DISCOUNTS

Nasco Heart Game

Gr. 7+ Reviews cardiac anatomy and physiology, both diagnostic and assessment. Players learn the basic principles of cardiac assessment, trace circulation of blood, identify the anatomical components and normal regulatory mechanisms of the heart, and more by answering Question Cards. For 2-6 players or teams. **CHOKING HAZARD (I)**. Not for under 3 yrs. **SB06772 – \$30.45**



F

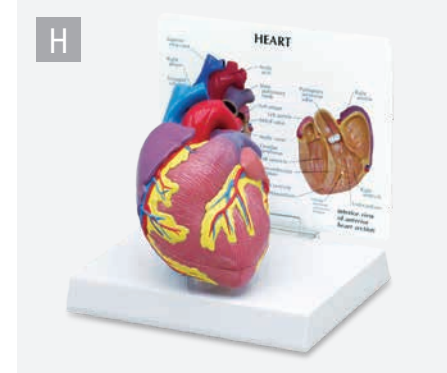

H



I

E. 4-Piece Artery Model

4-stage cross section of an artery demonstrates atherosclerosis. The 4 stages include normal artery, fatty streak, fibrous plaque, and blockage. Each model is 3 1/2" x 1 3/8" dia. **SB42963 – \$82.25**

F. Pumping Heart Model

Gr. 3+ Uses a simple hand pump to demonstrate basic heart and pulmonary blood flow. Liquid is sealed in. 12" x 11" x 5". **CHOKING HAZARD (I)**. Not for under 3 yrs. **SB48204 – \$60.90**

G. Life-Size Heart Model (2-Part)

Can be removed from base. Good visibility of the chambers, valves, and great vessels. 6 1/4" x 3 1/2" x 3 1/4". Key included. **SB25200 – \$34.51**

H. Heart Model (2-Part)

Model opens in half to show inner chambers and valves as well as aortic arch, superior and inferior vena cava, and pulmonary and cardiac veins. Mounted on stand. Model: 3 3/4" x 4" x 4 1/4". Information card: 6 1/2" x 5 1/4". **SB32595 – \$112.00**

I. Cross-Section Heart and Brain Model Set

Foam models with one side labeled and other side blank. Each model represents a 5" cross-section in the actual shape of the organ. Includes guides. **SB42007 – \$43.95**
SB42005 Heart – \$21.26
SB42006 Brain – \$20.25

Keep exploring at
nascoeducation.com

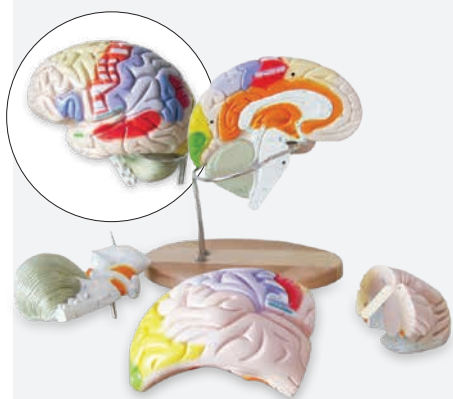

Large Brain Model
Life-size human brain represents a right-handed person. Color coding and hand-lettered captions locate and identify motor and sensory functional centers with emphasis on intellectual role of left brain and creative role of right. Identifies key structural features that correspond to manual. 9" x 8" x 11¹/₁₆".
SB48436 – \$289.28



Human Brain Model (8-Part)
Life-size human brain molded from PVC plastic and hand-painted to show lobes. Can be removed from rotating metal harness. Guide indicates 50 labeled brain structures. One side of guide includes names, while other side shows only numbers for student assessment. Harness mounted on plastic stand.
SB51339 – \$279.13

EXCLUDED FROM DISCOUNTS

3B Scientific Human Skull with Facial Muscles
Gr. 6–12 Display the human skull with facial muscles for students to examine in the classroom. Use the model to demonstrate facial anatomy concepts as well as causes of temporomandibular disorders and other dysfunctional disturbances of masticatory muscles. The jaw is movable and its cranium and masseter muscle are detachable. This model includes free access to the anatomy course 3B Smart Anatomy, which includes 23 digital anatomy lectures, 117 different virtual anatomy models, and 39 anatomy quizzes to test student knowledge using the Complete Anatomy app by 3D4Medical.
NE40273 – \$431.46



See how all parts of the human ear work together

3B Scientific Human Ear
Enlarged three times. Dissectible into four parts. Removable ear ossicles with dissectible cochlea. 13¹/₃" x 6¹/₄" x 7²/₅" on base. Teacher's guide.
SB19254 – \$183.60

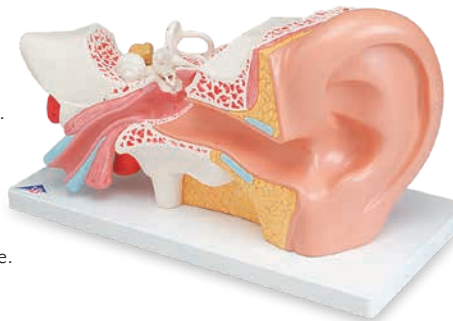

American 3B Giant Eye Model
Five times actual size. May be dissected into six parts. Upper half of sclera with cornea and eye muscle attachments, both halves of choroid with iris and retina, lens, and vitreous humor are removable. Comes on base with key card. 4³/₄" x 4³/₄" x 8¹/₂".
SB27614 – \$214.20

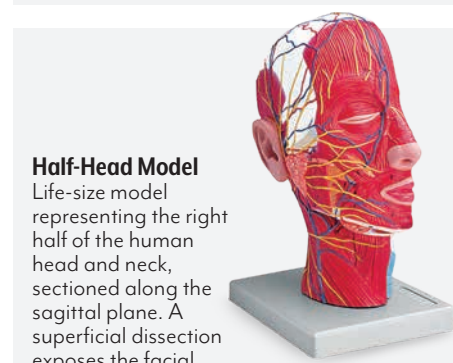

Half-Head Model
Life-size model representing the right half of the human head and neck, sectioned along the sagittal plane. A superficial dissection exposes the facial muscles, the superficial blood vessels and nerve branches of the face and scalp, and the parotid and submandibular glands. A median dissection exposes the brain with its internal structure, the pharynx and upper respiratory tract, and a section of the cervical vertebrae. Mounted on base. 8" x 6" x 11¹/₂".
LA00140 – \$259.00

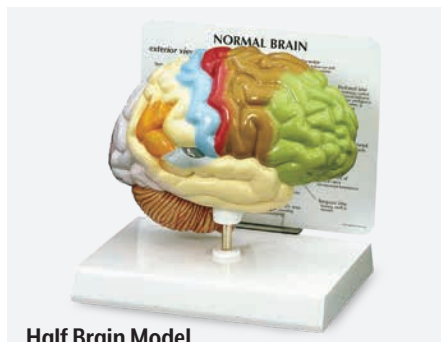

Half Brain Model
Demonstrates sensory/motor functions. Normal right half brain with frontal, parietal, occipital, and temporal lobes; cerebellum; interthalamic adhesion; corpus callosum; pons; midbrain-central peduncle; olfactory bulb; optic nerve; optic chiasm; mammillary body; and medulla oblongata. 6¹/₂" x 5" x 2¹/₂".
SB40235 – \$99.95



Human Skull with Brain Model (8-Part)
Life-size, with accurate representations of all sutures, fissures, joints, foramina, and processes. Jaw is spring mounted and detachable. Removable skullcap. Includes key. 9" x 6" x 6".
SB51054 – \$257.40



A. Clear Human Jaw with Teeth
Full-size, hinged, clear cast jaw allows viewing of roots. Healthy side shows normal dentition and occlusion. Affected side shows multiple pathologies. Model: 3¹/₂" x 2³/₄" x 2¹/₂". Card: 6¹/₂" x 5¹/₄".
SB48717 – \$168.30

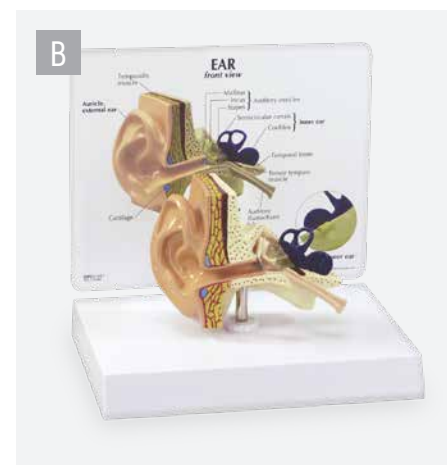

B. Human Ear Model
Fully assembled, full-size model shows canal and inner ear mechanisms. 3³/₄" x 2¹/₂" x 2³/₄" without base. Card size: 6¹/₂" x 5¹/₄".
SB32980 – \$109.95



C. Giant Hands-On Eyeball (5-Part)
Enlarged six times. Lens magnifies objects and forms inverted images. Remove transparent vitreous body to see light-sensitive retina. The two-page guide discusses 19 features. Mounted on wooden base. 6" x 6" x 6".
SB31473 – \$332.51

D. Classic Eye (6-Part)
Three times life size. Includes teacher's guide. 4" x 4" x 6".
SB19256 – \$142.80

JOURNEY THROUGH THE HUMAN BODY with detailed models



Human Skull (3-Part)
Life-size. 18th left mandibular molar, 22nd left mandibular canine, and 24th left central incisor are removable to show roots. Spring-mounted mandible and sectioned calvaria are detachable. 5¹/₂" x 8" x 6".
SB25937 – \$55.00



Numbered Human Skull Model (3-Part)
Removable skullcap and articulated mandible. Significant structures are numbered. 8³/₈" x 5¹/₂" x 6¹/₄".
LA00176 – \$101.95



Colored Human Skull
Life-size model features 22 colored bones. Identification key corresponds to the 22 different colors. 8" x 8" x 5¹/₂".
SB50960 – \$174.58

BEST SELLER



American 3B Classic Skull (3-Part)
Highly accurate representation of fissures, foramina, processes, sutures, etc. Can be disassembled into skull cap, base of skull, and mandible. 9" x 6" x 6³/₄".
SB33945 – \$153.00

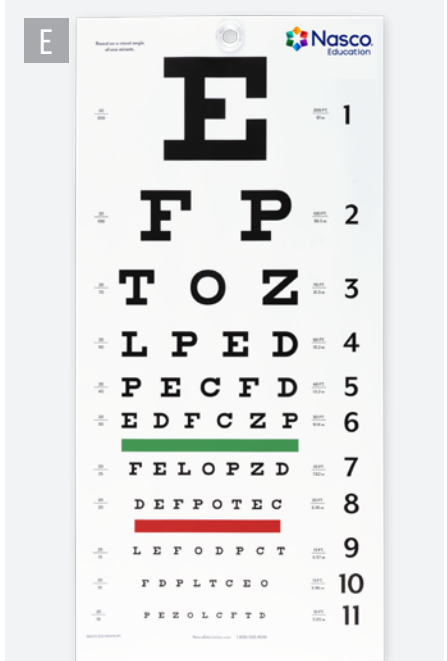

E. Snellen Eye Examination Chart
Wall chart for use at a distance of 20'. 11" x 22".
SB16711 – \$12.00



ONLY AT NASCO

Nasco Inflation Lungs Comparison Kit with Teacher Instructional DVD
Inflation racks provide an impressive and unforgettable hands-on demonstration by using real swine lungs. This kit is designed to demonstrate the effects of prolonged smoking, as well as compare the differences in color and texture of a simulated smoker's lung and a healthy lung. Nasco uses a nontoxic solution that retains the texture and elasticity of fresh lungs, to preserve them. The smoker's lungs have a palpable internal tumor and a physical simulated external tumor to encourage students to feel the texture of real lung tissue and its variations. This kit includes an inflation rack assembly with tray, an air pump, a simulated healthy and smoker's lung, a dried cross section of a lung, an instructional DVD, a teacher's guide, and storage containers. The guide provides a detailed illustration of internal/external anatomy and supplemental information about lung cancer, other smoking related diseases, and air pollutants as well as guidelines for handling, use and storage of the reusable swine lungs. CHOKING HAZARD (I). Not for under 3 yrs.
LS03769 – \$490.00



EXCLUDED FROM DISCOUNTS

9-Liter Student Wet Spirometer
Determine five different respiratory volumes: tidal volume (TV), inspiratory capacity (IC), inspiratory reserve volume (IRV), expiratory reserve volume (ERV), and vital capacity (VC). Large, easy-to-read scale graduations, larger-than-normal 9-liter capacity, disposable mouthpieces, and one-way plastic valve for sanitary classroom use.
SB31479 – \$730.80

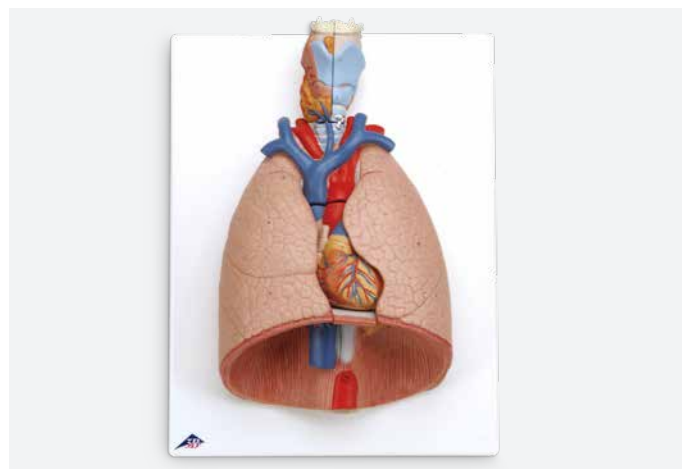

3B Scientific Deluxe 7-Part Lung Model with Larynx
This first class model illustrates: two-part larynx (removable), trachea with bronchial tree, two-part heart (removable), subclavian artery and vein, vena cava, aorta, pulmonary artery, esophagus, two lungs (front halves removable), and diaphragm. Model comes mounted on a sturdy baseboard and includes key card. Dimensions: 12¼" x 16" x 4¾".
SB41144 – \$690.14



ONLY AT NASCO



ONLY AT NASCO



ONLY AT NASCO

A. Nasco Healthy Inflation Lungs Kit
Students can see and learn how lungs work by inflating and deflating them with a pump. Includes an inflation rack with tray, air pump, a pair of reusable, inflatable swine lungs, a section of dried swine lung, a teacher's guide, and a container for storing the lungs. **LS03765 – \$300.00**
LS03764 Nasco Inflation Healthy Lungs Only – **\$210.00**

B. Nasco Dual Lungs Comparison Kit
Interconnected airway system with dual trays, air pump, pair of normal inflatable swine lungs, pair of simulated smoker's lungs, dried swine lung section, and 2 guides.
LS03802 – \$540.00
Dual Lung Rack Update Kit. Converts inflatable lung comparison kit to dual lung rack. **LS03805 – \$85.00**

C. Nasco Smoker's Lungs Demonstration Kit
Realistically stained inflatable swine lungs provide an unforgettable demonstration of prolonged smoking. Simulated internal and external tumors on each lung remind that smoking is a known cause of lung cancer. Kit includes a teacher's guide, inflation rack and tray, air pump, dried cross section of unstained lung, and simulated smoker's lung. **LS03767 – \$310.00**
LS03766 Replacement Simulated Smoker's Lungs Only – **\$220.00**

Nasco Lungs Maintenance Kit
Includes necessary materials plus special instructions for prolonging the life of your inflatable lungs. **LS03738 – \$38.50**
SB29032 Bellows Pump – **\$25.95**



Lung Demonstration Apparatus
Uses break-resistant bell jar to represent thoracic cavity, rubber dam as diaphragm, Y-shaped tube as trachea and bronchial tubes, and two balloons as lungs. Manipulate diaphragm to inflate and deflate balloons. 11" x 5" x 5".
S07746 – \$55.00



EXCLUDED FROM DISCOUNTS

Life-Size Lung Model (5-Part)
Life-size model shows the following features: larynx, trachea with bronchial tree, 2-part heart (removable), vena cava, aorta, pulmonary artery, esophagus, and 2 lungs (front halves removable). Mounted on baseboard. 4¾" x 11" x 14½".
SB41444 – \$428.40

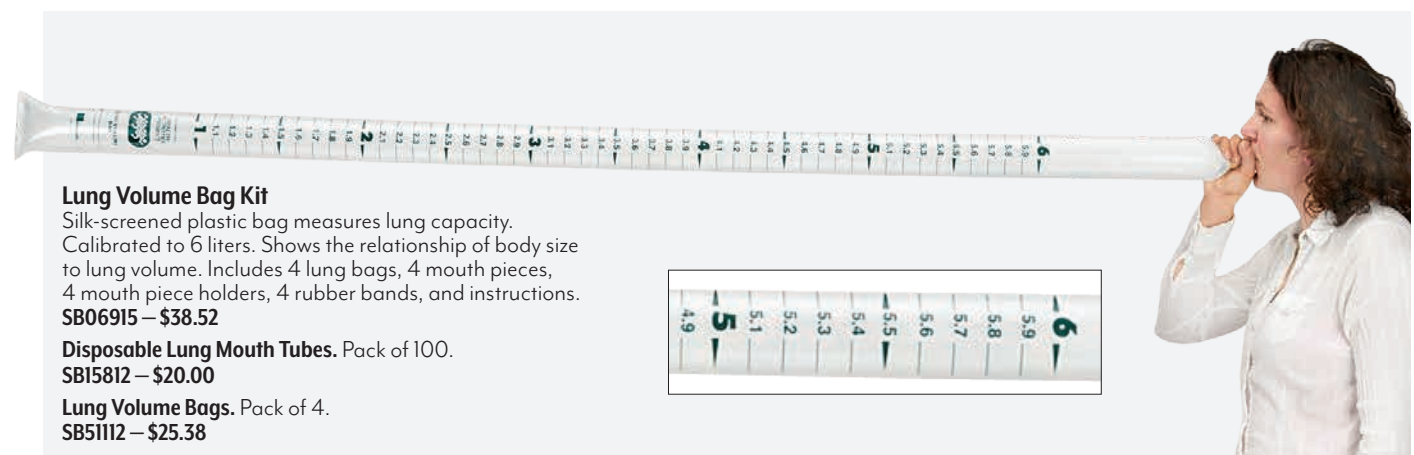

Lung Volume Bag Kit
Silk-screened plastic bag measures lung capacity. Calibrated to 6 liters. Shows the relationship of body size to lung volume. Includes 4 lung bags, 4 mouth pieces, 4 mouth piece holders, 4 rubber bands, and instructions.
SB06915 – \$38.52
Disposable Lung Mouth Tubes. Pack of 100.
SB15812 – \$20.00
Lung Volume Bags. Pack of 4.
SB51112 – \$25.38

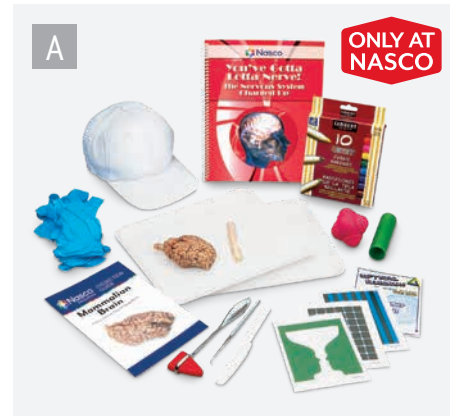

Nasco Human Body System Kits

Learn how the circulatory, respiratory, and nervous systems work, identify each system and its parts, and see each system in action. Includes one of each of the three kits below. **CHOKING HAZARD (1)**. Not for under 3 yrs. **SB52085 – \$155.95**

A. Nervous System

Learn to identify the structures of the brain and the functional areas, discuss memory, and see how illusions can fool our brains. **CHOKING HAZARD (1)**. Not for under 3 yrs. **SB51904 – \$54.95**



B. Breathe Easy Respiratory System

Learn all the primary parts and functions of the respiratory system, understand the diaphragm, and more. **CHOKING HAZARD (2)**. Not for under 8 yrs. **SB51905 – \$49.95**



C. Complex Circulatory System

Learn how to listen to your heart, find your pulse, and the components of the heart. **CHOKING HAZARD (1)**. Not for under 3 yrs. **SB51906 – \$52.95**



Nasco PPE Trainer Classroom Kit

Get everything you need to help students practice the correct ways to don and doff PPE. Kit includes 20 pairs of latex-free gloves (10 medium and 10 large), 25 disposable face masks, 20 face shields, and 20 disposable isolation gowns. To download the corresponding lesson plan, visit nascoeducation.com/lesson-plans and search U28164. **NE40277 – \$66.98**

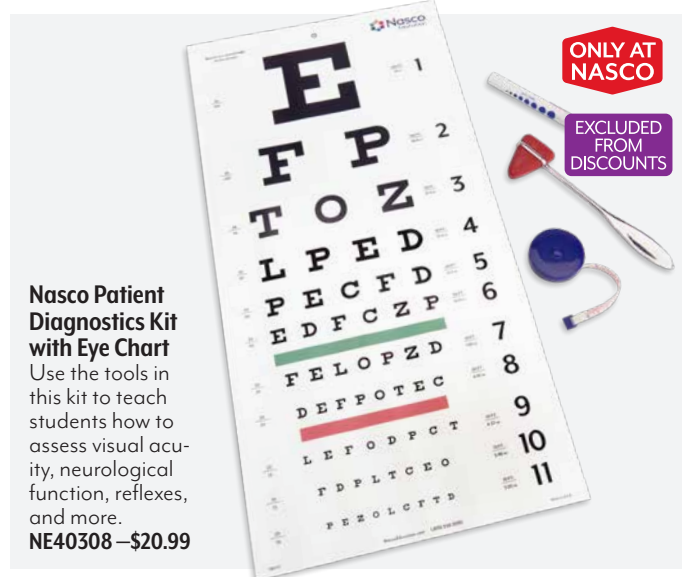

Nasco Patient Diagnostics Kit with Eye Chart

Use the tools in this kit to teach students how to assess visual acuity, neurological function, reflexes, and more. **NE40308 – \$20.99**

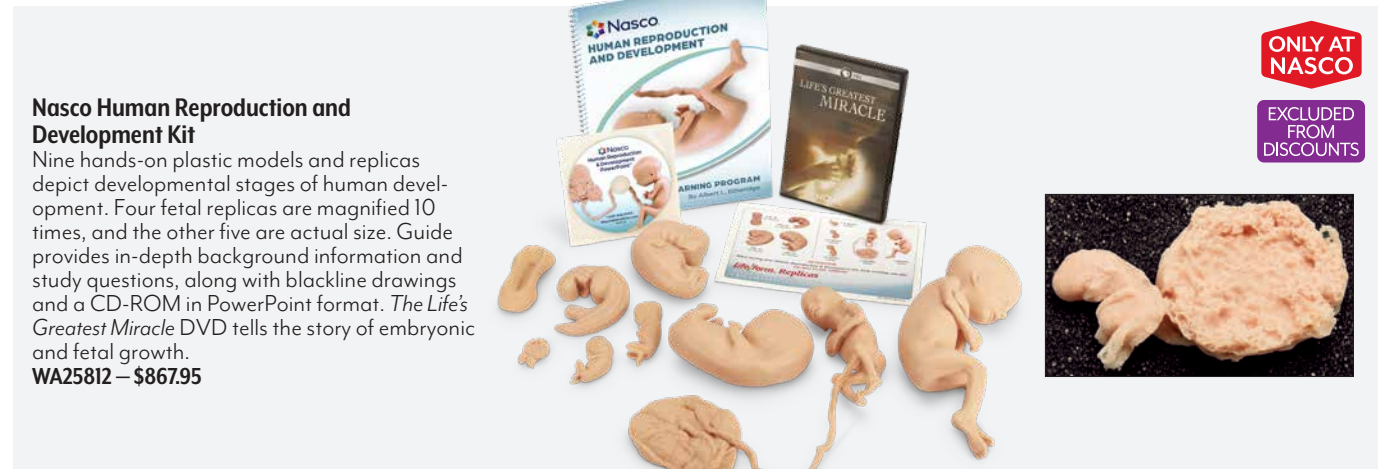

Nasco Human Reproduction and Development Kit

Nine hands-on plastic models and replicas depict developmental stages of human development. Four fetal replicas are magnified 10 times, and the other five are actual size. Guide provides in-depth background information and study questions, along with blackline drawings and a CD-ROM in PowerPoint format. *The Life's Greatest Miracle* DVD tells the story of embryonic and fetal growth. **WA25812 – \$867.95**



Fetus Development Set

Set of 8 models (14 pieces) on bases illustrates the detailed stages of pregnancy development. First-month embryo, second-month embryo, third-month embryo, fourth-month fetus in transverse lie position, fifth-month fetus in breech position, fifth-month fetus in transverse lie position, fifth-month twin fetuses, and seventh-month fetus. Approximately 4½" x 6" x 8" each. **SB47759 – \$292.32**

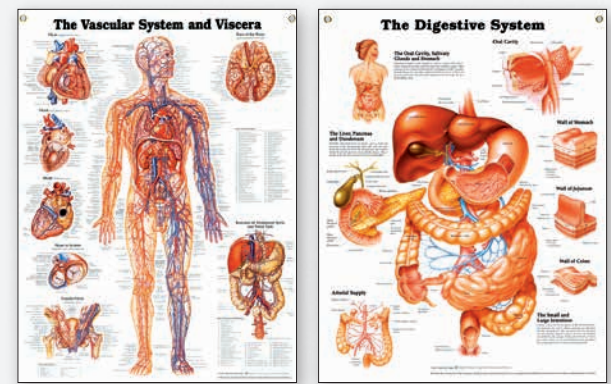

Peter Bachin Anatomical Chart Series

Lithographed in four colors with 3-D effects. Set of 10 includes Skeletal System, Muscular System, Vascular System and Viscera, Nervous System, Lymphatic System, Male Reproductive System, Female Reproductive System, Digestive System, Respiratory System, and Endocrine System. 26" x 20". Laminated. **SB25037 – \$286.00**



Stethoscope

Medium, flat chest piece (1¾" dia.) has single stem. Chrome-plated. Hard rubber ear tips. **SA01176 – \$11.11**



Fingertip Pulse Oximeter

Accurately and safely measures oxygen saturation of arterial hemoglobin and pulse rate. Accommodates a wide range of finger sizes. Large LCD display with red digital readout displays blood-oxygen saturation (SpO2), pulse rate, and pulse bar. One-button operation, low battery indicator, and auto shutoff. Latex free. Lanyard. English/Spanish instructions. **SB48022 – \$37.00**



Touch-Free Infrared Thermometer

Accurate for both body and object/liquid measurements. Features backlit display, memory recall of last 30 readings, fever alert display icon, auto shut-off, low-battery indicator. No tip covers required. Latex-free. **SB50075 – \$49.30**



Student Blood Pressure Kit

One-hand operation. Adult cotton D-ring cuff; black, no-stop pin, 300 mmHg gauge; separate professional stethoscope; vinyl carry case; illustrated instructions; and blood pressure chart. **SB10783 – \$24.06**

Don't see it here? Find it at nascoeducation.com

Assessing vital signs
Health Sciences Lesson Plan

To download this free lesson plan, visit nascoeducation.com/lesson-plans and search U28394.

NEW

Nasco ECG/EKG Trainer Kit

Gr. 9–12 Introduce students interested in healthcare careers to electrocardiograms and give them hands-on experience with this critical diagnostic tool. The included QuickStudy® guide shows how EKGs work and includes detailed sections covering the main types of arrhythmias, such as sinus rhythms, atrial rhythms, junctional rhythms, ventricular rhythms, and heart blocks. Helpful illustrations, along with the rate, rhythm, P wave, PR interval, and QRS complex of each rhythm covered are also included to help with identification. Includes 1 QuickStudy® EKG/ECG Guide, 1 EKG Ruler, and 1 ADC® Precision ECG Caliper. Practice EKG strips are not included, but are easy to find online.

NE40553 – \$19.99

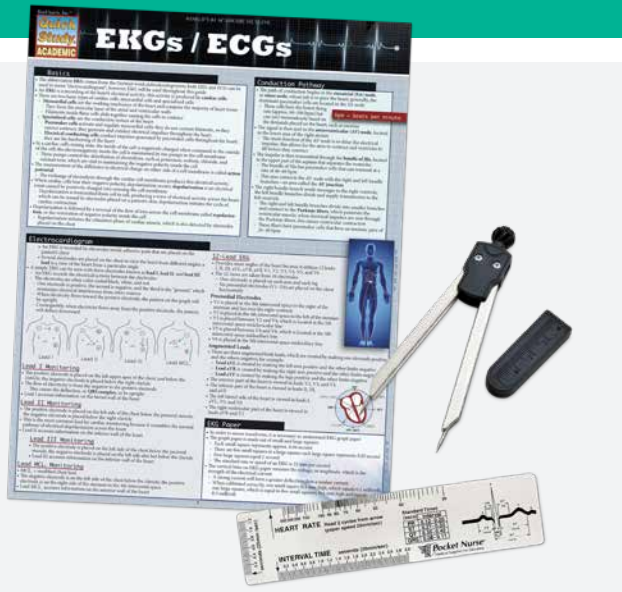

Health Careers Bingo

Gr. 6+ Familiarizes students with various healthcare professions and medical equipment. For up to 30 players. ⚠ CHOKING HAZARD (1). Not for under 3 yrs.

SB40266 – \$109.95



5-Minute Health Sciences Activities

Gr. 7+ Filled with activity ideas, including medical ethics, healthcare services and careers, medical equipment, body systems, nutrition, and more. 50 pages.

WA32531 – \$38.65



5-Minute Racism, Diversity, and Identity Activities

Gr. 6+ Quick, easy, and effective activities to introduce lessons, reinforce learning, fill extra minutes of class time, or summarize a unit. Topics: race, diversity, personal identity and more. 50 pages.

SB52825 – \$38.65

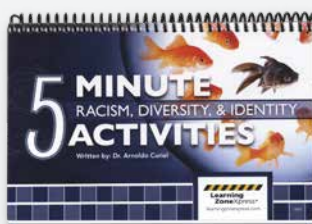

Mosby's Medical Terminology Flash Cards

These 650 full-color illustrated cards are for students who want extra help memorizing prefixes, suffixes, and combining forms used to build medical terms. Cards provide word-building examples, common medical abbreviations, and Spanish translations. Fourth edition.

SB48058 – \$49.13

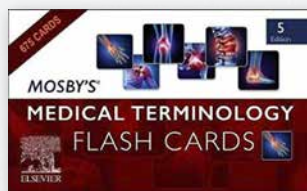

Health Hints Game

Gr. 6–12 Learn about healthcare terminology and careers with a fast-paced game. Teams compete to guess as many word cards as they can in 60 seconds. Includes 140 two-sided cards, timer, instructions, and game bell.

NE40390 – \$104.95



Nasco Vision Challenges Simulation Glasses Set

Create the realities cataracts, glaucoma, macular degeneration, retinopathy, hemianopsia, and detached retina. Set of 6 pairs of glasses, and user guide with visual challenges worksheets.

SB50159 – \$26.34

ONLY AT NASCO

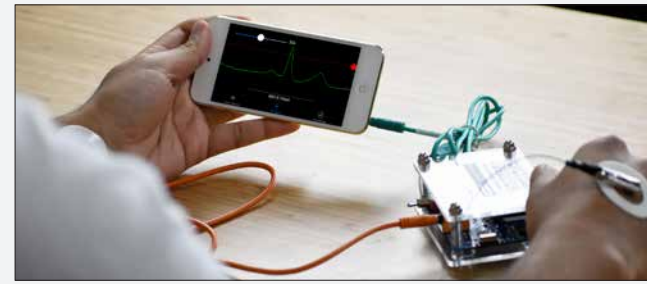

Muscle SpikerBox Kit

Introduce students to electrophysiology with hands-on experiments. Kits allows students to listen to and record bioelectrical signals and display them live on a smartphone, tablet, or laptop. Pro kits also offer USB connectivity, 2 recording channels, sounds loud enough for the entire class to hear, 5 time stamp markers for your experiments, and 2 analog inputs for recording lab devices. Pairs with SpikeRecorder free software, which offers basic and advanced analytics functions.

SB52268 – \$169.95



EXCLUDED FROM DISCOUNTS

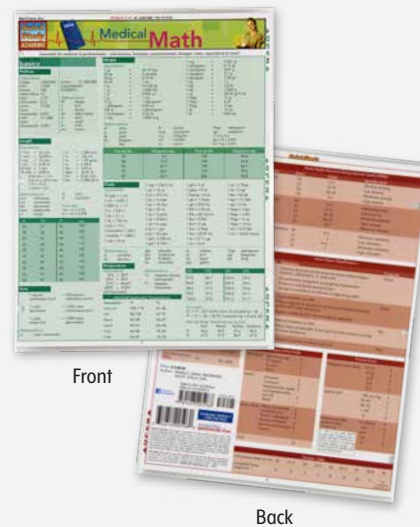

QuickStudy® Medical Math Guide

Features essentials for students and professionals – calculations, formulas, measurements, dosages, rates, equivalents, and more. The six-page guide includes detailed information on basics, calculations and formulas, coding measurements, pediatric definitions, and clinical indicators. 8½" x 11". Laminated.

SB50867 – \$7.50



Nasco "Now What?" Game

Players make decisions in simulated nursing care situations. Emphasizes physiological, pathophysiological, pharmacological, and psychological concepts as they relate to situations. For 2–4 players. ⚠ CHOKING HAZARD (1). Not for under 3 yrs.

SB07847 – \$60.90

EXCLUDED FROM DISCOUNTS

ONLY AT NASCO

Nasco Communication Game

Presents a variety of real-life hospital situations which engage players in learning communication techniques to perceive clients' feelings, and choose responses which are both timely and sensitive. For 2–6 players or teams. ⚠ CHOKING HAZARD (1). Not for under 3 yrs.

SB07279 – \$33.44



ONLY AT NASCO



Human Senses (Physiology) Experiment Kit

Students experiment to identify response areas of their body, and become aware of their sensory perception. They will map taste sensations and nerve endings, determine olfactory fatigue, investigate blind spots, and more. For 30 students. ⚠ CHOKING HAZARD (1). Not for under 3 yrs.

◆ SA01213 – \$170.00

⚠ See page 3 for complete Choking Hazard Label Information.

◆ DOT hazardous material ⚡ Subject to DOT hazardous material surcharge.



Life/form® Advanced Venipuncture and Injection Arm

Extensive eight-line vascular system for IV therapy and phlebotomy, plus sites for intramuscular and intradermal injections at primary and secondary locations. Flexible fingers and wrist, replaceable skin, and veins. Skin rolls as the veins are palpated and a discernible “pop” is felt when entering the veins. Includes simulated blood, one 3cc syringe, one 12cc syringe, needle, two fluid bags, instruction manual, and soft carry case. 5-year warranty.

Complete venous access:

- Basilic V.
- Cephalic V.
- Digital V.
- Dorsal metacarpal V.
- Median basilic V.
- Accessory cephalic V.
- Extensive venipuncture system
- Flexible fingers and wrist
- Intradermal injections
- Intramuscular injections
- Median antebrachial V.
- Median cephalic V.
- Median cubital V.
- Replaceable skin and veins
- Thumb V.

LF01121 Light LF01250 Medium LF01126 Dark
Each — \$949.95



EXCLUDED FROM DISCOUNTS

Life/form® Deluxe Blood Pressure Simulator

A simulator for teaching physical assessment, this Blood Pressure Simulator helps resolve the uncertainties common in teaching students to take blood pressure. Features include:

- Durable control unit
- Palpable radial pulse
- Simple calibration
- Audible discernment of the five Korotkoff phases
- Systolic and diastolic settings
- Adjustable volume
- Ability to turn auscultatory gap on or off
- Adjustable pulse rate
- Easy calibrated unit for use with any sphygmomanometer
- Ability to broadcast blood pressure sounds to an entire classroom with included speaker system
- 5-year warranty

LF01129 — \$1,640.25

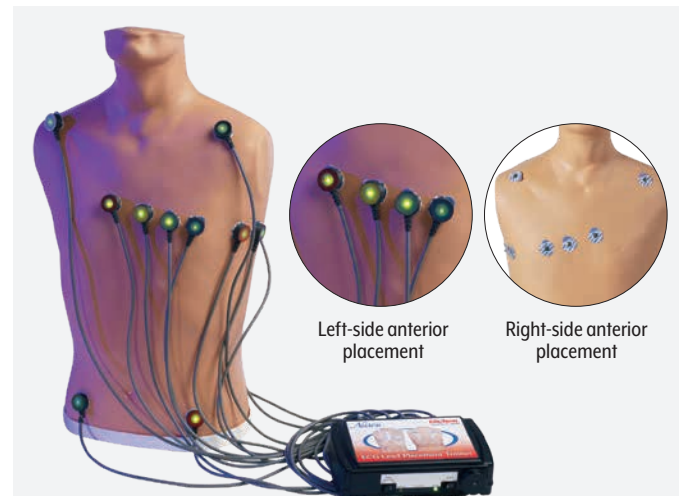

Left-side anterior placement Right-side anterior placement

Life/form® 15-Lead ECG Placement Trainer

Teaches up to 15-lead ECG electrode placement anatomically and provides visual feedback on the accuracy of electrode placement. Students will learn the placement of the electrodes on the adult trainer using anatomical landmarks such as intercostal spaces, midclavicular line, anterior axillary line, midaxillary line, and scapula. Features connection sites for four limb leads and V1 through V9, with the ability to attach right- or left-sided electrodes. The trainer does not provide ECG output signals, but simulations of rhythms and hands-free defibrillation can be performed by adding any ECG arrhythmia simulator directly to your ECG monitor. Includes adult torso, 15-lead electronics box, power adapter, set of 13 leads, 50 electrodes, two C batteries, hard carry case, and instruction manual. 5-year warranty.

LF01300 — \$4,610.95



SB52446

VATA, Inc. Suture Skills Trainer

- Realistic tissue pad consists of 5 anatomically correct tissue layers: epidermis, dermis, subcutaneous fat, fascia, and muscle
- Each individual layer is identifiable and has anatomically correct color, strength, firmness, and feel
- Unique materials used allow for practicing superficial, subcuticular, and complex deep wound suturing
- With proper tension, the suture will not “tear through”
- Tissue pad moves just like real human tissue when making an incision or when suture tension is applied
- Sutures can be removed and you can reuse the site numerous times
- Comes with a proprietary tensioning device for use with the tissue pad, so the user can adjust the distance between the 2 cut tissue edges
- Offers the user a more realistic feel and increases the challenge when closing the tissue under varying degrees of tension
- Instruments are of a much higher quality than those generally supplied with suture models
- Trainer comes with everything you need:
 - o Tension device
 - o Needle driver
 - o Adson 1-2 forceps
 - o Hooked Littauer scissors
 - o Surgical safety scalpel
 - o 12 nylon sutures
 - o Disposable skin stapler
 - o Carrying case

SB52444 Light SB52446 Dark
Each — \$264.00

Life/form® Venatech IV Trainer

- Easily attaches to a person’s arm so student can practice venipuncture techniques on a live subject, including the proper positioning on an actual human arm, without the risks associated with puncturing living tissue
- Ideal for practicing starting IVs
- Includes the 3 main veins used in phlebotomy — cephalic, basilic, and median cubital — all in correct anatomical position
- Arterial vessel is present for arterial blood gas simulation
- Helps students learn essential communication skills and patient interaction
- 5-year warranty

LF01162 Light LF01163 Dark
Each — \$114.95

EXCLUDED FROM DISCOUNTS



EXCLUDED FROM DISCOUNTS

Life/form® Canine IV Leg

A fully functional canine IV leg trainer at an affordable price. Represents the left foreleg of a medium-sized dog in the sternal recumbent position with two interchangeable sleeves — normal fur for routine blood draws and a “shaved” area for IV catheter insertion. Replaceable vein system demonstrates actual blood flashback. Great for bandaging and restraint/assistance practice as well. Ideal for veterinary schools and vet tech programs. Portable storage box with built-in IV pole, blood powder, syringe, IV catheter, and two fluid supply bags. LF01016 — \$301.95



Practice Suture Kit

Includes suture pad, 6 1/2" W x 5 3/4" L x 1/2" H; a variety of realistically textured common cuts and lacerations; self-healing plastic pad; 5" needle holder; toothed forceps; suturing scissors; and 3 suture varieties with needles and tubing pieces. NE40443 — \$57.95

CasPeR the CPR Dog

CasPeR the CPR Dog provides training in mouth-to-snout resuscitation with individual-use, disposable airway bags. These economical disposable shield/lung bags eliminate cross contamination between students and the need to disinfect the manikin after every use. This dog manikin can be used to teach proper hand placement for compressions, depth of compressions, airway maintenance, femoral pulse check, and adequate ventilation. Airways are changed quickly and without tools. 3-year warranty. 100-5000 — \$465.95



EXCLUDED FROM DISCOUNTS

Vet Tech Surgical Instrument Kit with Identification Flash Cards

Learning to identify veterinary instruments is made easier when users can handle each instrument and compare action, weight, and feel. Includes 29 of the most common instruments with display case and flash cards. Care and handling instructions are also included. For more information, visit nascoeducation.com. C33788 — \$429.99



EXCLUDED FROM DISCOUNTS

Suture Thread with Needle

For use with Life/form® Suture and Stapling Practice Trainers (LF01028, LF01034, and LF01042). Includes 4-0 reverse cutting nylon suture. Product is for educational use only, Nasco is not liable for products used for any means other than its intended use. LF07000 — \$4.50



Demo Dose® Inject-Ed Injection Pad

Compact and economical injection task trainer provides students with a realistic injection experience in the simulation lab. IM, SQ, ID, and Z-track simulation. Resilient, durable, and self-healing surface fluid. Holds up to 20 ml. 3" dia. x 1 1/2" H x 2 1/4" injection area. PN01195 — \$33.66



CPR Prompt® Training and Practice Manikin

Comprehensive design allows for practice of the Heimlich Maneuver and abdominal thrusts, as well as CPR and mouth-to-mouth breathing. Realistic anatomical markings (Adam's apple, carotid arteries, navel, rib cage, chest notch) make it easy to learn correct hand placement for checking pulse, performing chest compressions, and more. Head tilt/chin lift required to open airway. Audible compression "clicker" (adult/child, only) to ensure proper technique. Lung bags are replaceable. Designed to meet American Heart Association criteria for desirable manikin features. Includes 10 face shield lung bags and insertion tool, assembly instructions, and cardboard carry case with handle. 5-year warranty

CPR Prompt® skin tones available: Blue Tan

TMAN 1 Adult/Child Single Manikin. Includes age selector dial that adjusts chest compression piston for learning adult or child techniques.

LF06001 Blue *LF06003 Tan

*EXCLUDED FROM DISCOUNTS



NEW

Nasco First Aid & Blood Pathogens Deluxe Kit

Put your students' first aid skills to the test with these kits. During first aid training, simulate injury situations that need immediate attention so they are ready to help whenever there's an emergency. For more information, visit nascoeducation.com.

NE40227 — \$253.74



Basic Buddy® CPR Manikin

Airway opens using the head tilt/chin lift method, and there is a visible chest rise when ventilated. Xiphoid process provides an anatomical reference point for hand placement and compressions. Features both adult and child capabilities. 5-year warranty.

Basic Buddy® 10-Pack.

Includes 10 adult/child manikins, 100 lung/mouth protection bags, 10 lung insertion tools, 2 instruction manuals, and 2 carry cases. LF03695 — \$1,157.95

Basic Buddy® 5-Pack.

Includes 5 adult/child manikins, 50 lung/mouth protection bags, 5 lung insertion tools, instruction manual, and 1 carry case. LF03694 — \$628.95

Basic Buddy® Single Manikin.

Includes 1 manikin, 10 lung/mouth protection bags, 1 lung insertion tool, and instruction manual. LF03693 — \$138.95

Act+Fast™ Anti-Choking Trainers

Students wear trainer to learn the Abdominal Thrust Maneuver. When performed correctly, a foam plug shoots into the air, making instruction realistic and leaving students confident. Can be used standing, sitting, on the ground, or for choking self-rescue by using a counter or chair. Each trainer has adjustable shoulder straps, air bladder for practicing Abdominal Thrust Maneuver, and 30 foam plugs (20 yellow standard plugs and 10 green easy plugs for beginners and children).

Red Trainer. Also includes foam back slap pad for additional choking rescue practice.

SB48084 Single Trainer — \$172.00
SB51829 Pack of 4 — \$565.00



Mini Anne Global

This low-cost CPR kit includes an inflatable Mini Anne® Personal CPR Manikin, a simulated AED trainer, and a plastic storage bag. The manikin includes landmarks for compression point location, a clicker for audible feedback on optimal compression depth, and ventilations with visible chest rise.

NE40367 — \$37.43

Mini Anne Lungs

Pack of 6 replacement lungs for Mini Anne® Personal CPR Manikin. NE40368 — \$15.60

Overall attributes

- Lightweight — approximately 28 lbs.
- Full-size adult manikin — measures 58"
- Overall female appearance — converts to male with removal of wig and attachment of male genitals

- Ideal for OBRA-required training
- Life/form® 5-year warranty

Visual inspection training

- Normal and cancerous mole
- Stage 1 sacral ulcer
- Dilated and constricted pupils
- Reddened skin folds

- Major joints have natural movement to provide realistic practice of patient handling

Patient care simulation

- Bandaging and wound dressing
- Bed baths, hair care, and clothing changes
- Denture placement and removal — upper and lower
- Ear canal irrigation, otic drops, and hearing aid placement
- Eye irrigation

- Finger and toe manipulation with bandaging
- Intramuscular injection sites
- Oral and nasal hygiene
- Ostomy care — ileostomy and colostomy
- Patient positioning and transferring techniques
- Peri and tracheostomy care

Life/form® Complete GERi™ and KERi™ Manikins

Includes all of the main features listed above with the addition of:

- Enema administration — female only
- Gastrostomy procedures — lavage and gavage
- Internal fluid reservoirs
- Nasogastric tube placement

- Pap smears and douching
- Prostate exam — Stage B
- Urinary catheterization — female and uncircumcised male

LF04001 GERi™ — Light
LF04116 GERi™ — Medium
Each — \$2,571.95

LF04020 KERi™ — Light
LF04121 KERi™ — Medium



GERi™ has an elderly appearance with skin wrinkles and folds.



KERi™ has a non-age-specific appearance.



Gaumard® Simple Susie Nursing Care Patient Care Simulators

Full-size adult patient simulator designed with many versatile features for hands-on general patient care skills training. This manikin allows participants to practice safe patient handling, ophthalmic exercises, oral hygiene, vaginal douching and pap smear exercises, and more.

Features:

- Full body
- Eyes open and close
- Realistic eyes for ophthalmic exercises
- Upper and lower dentures for oral hygiene
- Simulated ear canal for otic drops and irrigation
- Soft, realistic face skin, hands, feet, fingers, and toes
- Stylish wig for haircare exercises and surgical draping
- Articulating head, jaw, elbows, wrists, ankles, and knees

- Bathing and bandaging activity
- Tracheostomy care
- Realistic vagina and cervix supports douching and pap smear
- Bends and detaches at waist for easy storage
- IM injection sites in deltoids, quadriceps, and upper gluteal region
- Advanced IV Training Arm add-on available (SB23445)
- Optional carrying bag available (SB51681)
- Instruction manual

SB23540(L) Light SB23540(M) Medium SB23540(D) Dark
Each — \$1,111.87



Aged Simulation Suit

Allows students to personally experience age-related physical changes. Includes suit, pair of glass goggles, 40 ear plug pieces, 10 pairs of gloves, 4 ankle weights, 4 wrist weights, 100-piece belt cover, cane, and storage bag.

SB52973 Small *SB52975 Large
SB52974 Medium
Each — \$3,216.00

*EXCLUDED FROM DISCOUNTS



Protein Synthesis Manipulatives Kit

Features large manipulatives for demonstration and smaller manipulatives for student use of DNA, mRNA, ribosome, tRNA, and amino acid models. Demo manipulatives attach to blackboard. For assessment, each student is given a unique DNA sequence and asked to identify the resulting amino acid sequence. Includes teacher key and a kit demonstration CD. For 30 students. **SB37499 – \$364.95**

EXCLUDED FROM DISCOUNTS

Dynamic DNA Kits

Gr. 6+ Help students better understand how the genetic information in DNA is revealed and used. Accurate and easy to put together. Students can assemble the nucleotides, feel the hydrogen bonding of the A-T and G-C base pairs, and discover the double helical structure of DNA. Plus, they can twist and unwind the double helix to model DNA replication and RNA transcription. Each kit includes 5' hydrogen and 3' oxygen parts, oxygen atoms to model RNA; removable carbons for uracil; ATP, TTP, GTP, and CTP models; and teacher resources/lessons. Meets National Science Education Standards. For 4-8 groups of students. **NOTE:** Only available in the U.S. **Δ CHOKING HAZARD (I).** Not for under 3 yrs.

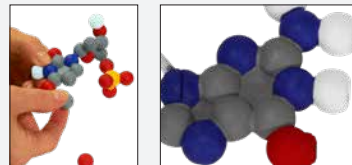

SB53145

2 Base Pairs Kit. Includes 1 A-T and G-C base pair. **SB53358 – \$58.00**

6 Base Pairs Kit. Includes 3 A-T and G-C base pairs. **SB53359 – \$156.00**

12 Base Pairs Kit. Includes 6 A-T and G-C base pairs, plus display stand. **SB53145 – \$298.00**

BEST SELLER



ONLY AT NASCO

Strawberry DNA Extraction Kit

Gr. 5+ Learn how to retrieve and isolate DNA from a strawberry. For 32 students working in pairs. **SB50009 – \$84.95**



DNA Starter Kit

Gr. 6+ Explore DNA replication and transcription with interactive foam model of double-stranded DNA and single-stranded RNA with color-coded DNA bases. Twist to transform from ladder shape to double helix. Two-group set includes 102 bases, 8 continuous gray backbones, 48 gray sugar-phosphates, and 24 lavender sugar-phosphates. Meets NGSS. **Δ CHOKING HAZARD (I).** Not for under 3 yrs. **SB49639 – \$100.00**

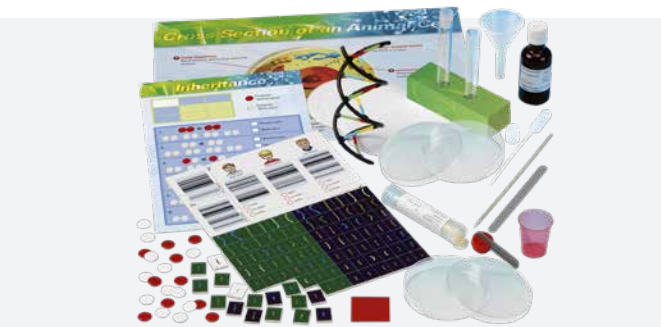

Genetics & DNA Kit

Gr. 4+ Head into the lab for an in-depth investigation of genetics, heredity, and variation in organisms and DNA. Experiments involve isolating the DNA from a tomato in a test tube, playing inheritance games to determine how traits will be expressed, and assembling a model of DNA. **SB49267 – \$35.95**



RNA/Protein Synthesis Kit

Use this 24-piece kit to make single-strand models of messenger RNA carrying the genetic code (codons) and component parts to represent transfer RNA and an amino acid. Also can be used to demonstrate the process of protein synthesis known as Translation. **Δ CHOKING HAZARD (I).** Not for under 3 yrs. **SB42167 – \$50.50**



Stick to Science – Genetic Cards

These 36 magnetic shapes represent males and females with three possible genetic combinations (affected, carriers, or not affected). Teacher's guide has actual case studies, lesson outlines, and reproducible student worksheets. **SB48332 – \$10.95**

DNA, RNA – Protein Synthesis Kit

Using individualized student worksheets and plastic, color-coded components, students first build a DNA molecule, replicate it, and use half of the "ladder" to build mRNA. Students conclude by disconnecting the protein chain from the tRNA and the tRNAs from the mRNA, showing their availability to continue the process. For 24 students working in pairs. **Δ CHOKING HAZARD (I).** Not for under 3 yrs. **SB20188 – \$299.95**



DNA Extraction and Isolation Kit

Gr. 6+ Extract DNA from strawberries and examine physical properties. Provides everything necessary (except strawberries) to conduct two extractions. For 32 students working in 8 teams of 4. **Δ CHOKING HAZARD (I).** Not for under 3 yrs. **SB40666 – \$129.95**



Individual DNA and Molecular Model Kit

Construct a model of an eight-rung ladder segment of the DNA molecule, then build a molecular model of the basic components of the nucleotides of RNA and DNA. Components are reusable. **Δ CHOKING HAZARD (I).** Not for under 3 yrs. **SB13744 – \$49.95**



BEST SELLER



Stick to Science – Punnett Squares

Gr. 7+ Includes 56 magnetic flowers show three types of monohybrid crosses (complete dominance, incomplete dominance, or codominance). Includes teacher's guide with sample questions. **SB53071 – \$19.95**

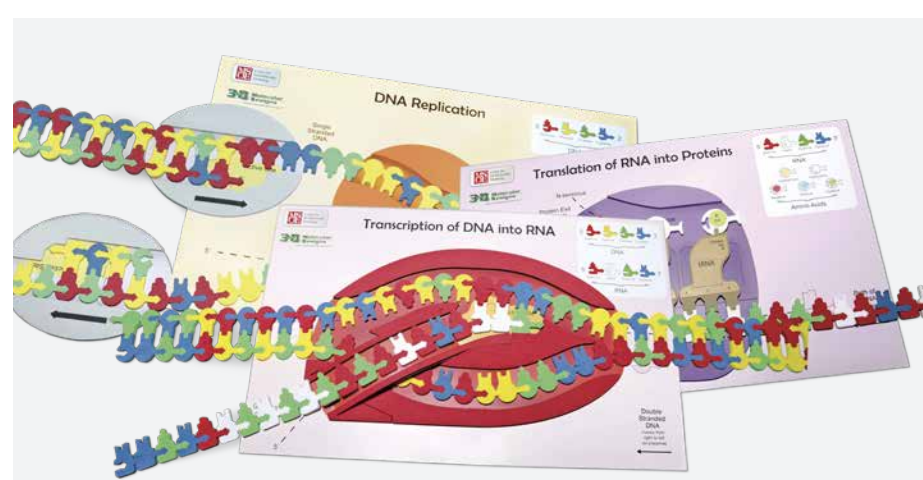

Flow of Genetic Information Kits

Gr. 9+ Lets students model DNA replication using color-coded, foam nucleotides and a place mat. They will be able to model replication of the leading and lagging strands of DNA, model transcription by copying one strand of DNA into mRNA using an RNA polymerase, and model translation/synthesis by decoding mRNA into protein on the ribosome place mat. **NOTE:** Only available in the U.S. **Δ CHOKING HAZARD (I).** Not for under 3 yrs. **SB53360 For 1 group – \$130.00**
SB53361 For 3 groups – \$375.00

BEST SELLER

Genetics of Corn Kit

For up to 32 students working in groups of four. A complete genetics lab for advanced high school classes and up. Covers basic Mendelian genetics, including segregation and independent assortment of alleles, dominance, genotype and phenotype, expected ratios, monohybrid and dihybrid crosses, and chi-square. Kit includes eight segregated ears each of purple-yellow, starchy-sweet, and purple-yellow-starchy-sweet; eight corn parental cross cards A and parental cross cards B, 16 transparency markers, storage box, and teacher's manual. **SB41056 – \$287.95**



EXCLUDED FROM DISCOUNTS

BEST SELLER

ABO-Rh Combination Blood-Typing Kit

All the features of the ABO Blood-Typing Kit are combined with an Rh Blood-Typing Kit, along with the addition of a Slide Guide® and worksheets. Serum does not require refrigeration and has no expiration date. Complete activity in one lab period. For 30 students. **SB13739(A) – \$182.60**

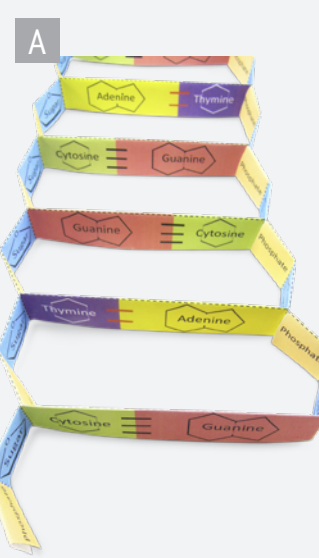

The Molecular Model of DNA and Replication Kit
Build an 8-rung ladder segment of the DNA molecule. Flexible model is twisted to form the double helix structure. 12 model segments can be attached to each other to make a "giant" double helix DNA model that can also be coiled and will be more than 9'L. **SB14279 – \$126.95**

A. NewPath Learning® DNA Structure 3D Model Kit
Gr. 5–10 Make base pairs and combine them to make a model of the DNA double helix. Includes materials for 5 paper models for students working in groups. Includes NGSS-aligned teacher guide. **NE30428 – \$36.95**

B. Advanced miniDNA™ Model
Gr. 9+ Shows all of the major and minor grooves. The 22 base pairs are comprised of 11 each of 4 color-coded bases. Side chain: 44 each of deoxyribose (red) and phosphate (purple). 4 5/16" x 17 7/16". Includes stand. **SB42166 – \$79.95**

12-Layer miniDNA™ Model. Gr. 9+ The 12 base pairs are comprised of 6 each of 4 color-coded bases. Side chain: 24 each of deoxyribose (red) and phosphate (purple). Approximate dimensions: 4 5/16" x 9 7/16". Includes stand. **SB42168 – \$37.95**

C. DNA Model
Gr. 7+ Built to a scale of 10 cm to 1 mm. Accurately depicts a 16 base pair section of DNA. Phosphate-deoxyribose backbone and 4 bases are represented by custom plastic moldings that show molecule shapes in scale and illustrate bonding between them. Central pillar can rotate on circular stand. Remove phosphate and deoxyribose components of backbone and individual base pairs for separate examination. 24". **SB45825 – \$75.95**



ABO Blood-Typing Kit
Students sample their own blood, determine their blood group, and receive firsthand awareness of tissue incompatibility. Blood serum requires no refrigeration. For 30 students. **SB13734(A) – \$132.95**



ABO/Rh Blood Typing Kit
Gr. 7+ The most procedurally accurate simulation of blood typing technique available. Students test and determine the ABO/Rh blood types of 4 different simulated blood samples. For 30 students. **SB48262 – \$55.00**



Determination of Blood Type Using Real Blood and Saliva Kit
Gr. 4+ Students test their own saliva to determine their ABO blood type by performing titers. Titrers will be performed using supplied screened and typed human blood samples. Redeem coupon for perishable components. For 30 students working in groups of 3. **SB51069 – \$171.95**



X-Act Blood-Typing Kit (A, B, O, AB, Rh, HIV)
Gr. 9+ Allows you to test a single "blood" sample for not only A, B, O, and AB major blood types, but also for the presence of Rh factor. All 8 blood types are represented. Screen the same "blood" sample for the presence of HIV antibody. For 3 classes of 24 students working in pairs. **SB27471 – \$49.95**

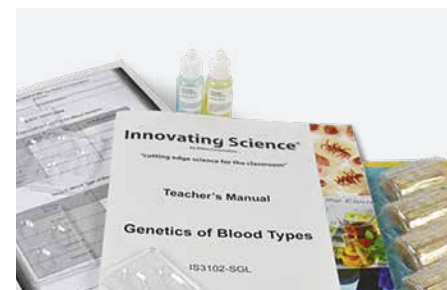

Genetics of Blood Types Kit
Gr. 7+ Resolve a fictional paternity suit by using simulated blood to determine blood type of 4 unknown samples. For 30 students. **SB46574 – \$56.95**



Simulated Blood-Typing Kit
Simulates blood typing, but requires no blood. Allows students to visualize antigen-antibody type relations and understand principles of blood typing. For 30 students working in pairs. **SB19152 – \$104.95**

INDIVIDUAL STUDENT SCIENCE KITS

Perfect for the classroom, after-school, independent study, summer school, and more



Gr. 7+ Students can work individually or in pairs with convenient student kits that have everything they need to investigate blood typing, chromatography, cellular respiration, and more!

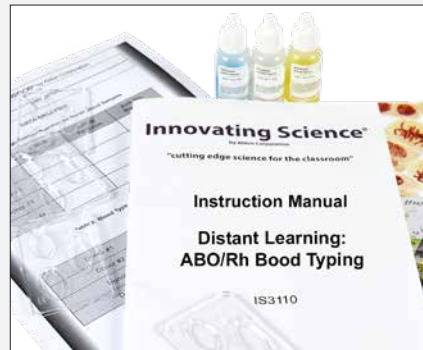

SB53423



NE30073

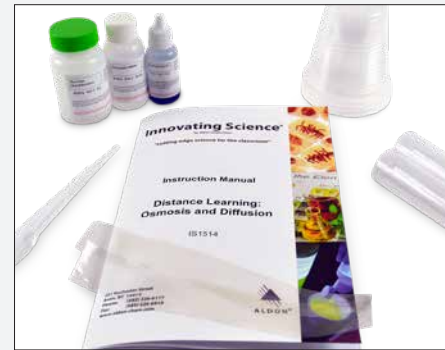

NE30081

Description	Students will ...	Product No.	Each
ABO/Rh Blood Typing	Test and determine ABO/Rh blood types of four different simulated blood samples.	SB53423	\$23.95
Cellular Respiration—What Sugar Does Yeast Like Best?	Expose living yeast cells to three different sugars—glucose, sucrose, and lactose—to see if they use the sugars as a food source to engage in aerobic respiration and/or fermentation.	NE30077	\$20.50
Chromatography of Plant Pigments	Use paper chromatography to separate the various pigments of a plant sample.	NE30078	\$20.50
Urinalysis Using Simulated Urine	Perform a test strip urinalysis on four urine samples, testing for glucose, protein, and ketones.	NE30080	\$27.50
Osmosis and Diffusion	Determine the effect of a solution temperature on the rate of diffusion of a solute. Then research osmosis: Gather data over a period of time in a created environment.	NE30081	\$15.95

Chromosome Connections Kit

Gr. 6-12 Help students understand the difference between chromosomes at microscopic and molecular scale. Enhance your classroom exploration of cell cycle, cell division and genetics with this hands-on kit. The colorful foam pieces can also be used to: model chromosome structure and anatomy; construct Punnett squares to connect inheritance of traits to chromosomes at the molecular level; compare and contrast mitosis and meiosis; model mechanisms that contribute to genetic variation; and model chromosomal aberrations such as non-disjunctions, translocations, inversions, deletions, and duplications. For groups of 2–4 students.
NE30093 — \$77.00

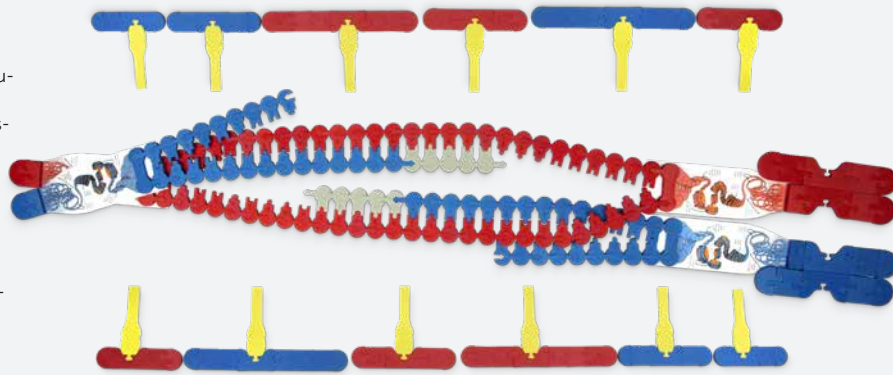

For complete descriptions, visit nascoeducation.com



Diffusion and Cell Size Lab

Gr. 7+ Learn about cell size by creating simulated cells (agar blocks) of different sizes and examining how effectively a substance is able to diffuse into the cell. For 15 groups of students.
◆ SB49031 — \$56.50



Cell Structure Kit

Observe the major components of plant and animal cells using simplified staining procedures.
SB08033 — \$99.50

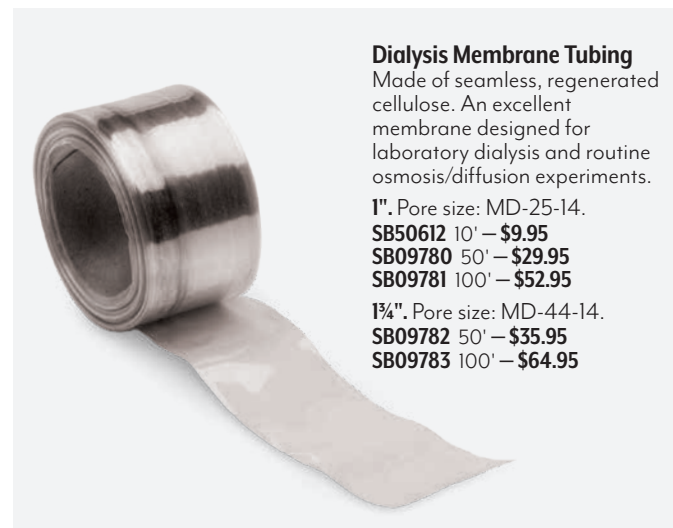

Dialysis Membrane Tubing

Made of seamless, regenerated cellulose. An excellent membrane designed for laboratory dialysis and routine osmosis/diffusion experiments.
1". Pore size: MD-25-14.
SB50612 10' — \$9.95
SB09780 50' — \$29.95
SB09781 100' — \$52.95
1 1/4". Pore size: MD-44-14.
SB09782 50' — \$35.95
SB09783 100' — \$64.95



Osmosis & Diffusion Kit

Allows students to observe diffusion through a membrane in two directions at the same time. In addition, they can observe the selective permeability of a membrane. For 30 students. **⚠ CHOKING HAZARD (I). Not for under 3 yrs.**
SA08212 — \$151.95



Kidneys and Blood Filtration Kit

Gr. 7+ Create an artificial kidney model to filter simulated blood, then chemically test the resulting filtrate to detect any possible waste material that may have been removed by the kidney. For 15 groups of students. **⚠ CHOKING HAZARD (I). Not for under 3 yrs.**
SB47397 — \$63.95

⚠ See page 3 for complete Choking Hazard Label Information.

◆ DOT hazardous material ⚡ Subject to DOT hazardous material surcharge.



Mendelian Genetics: Genes and Probability Lab

Gr. 7+ Simulate Mendel's work in genetics and determine patterns of inheritance. Using special chips and dice, students simulate both monohybrid and dihybrid crosses. Students then determine genotypic and phenotypic ratios for select traits and compare their values to the theoretical ideal values as put forth by Mendel. Contains enough materials for 15 groups. Kit includes 15 each of red/yellow monohybrid chips (female), red/white monohybrid chips (male), colored dihybrid double dice (female), clear dihybrid double dice (male), and plastic shaker cups. **SB49024 — \$82.95**



SB53097



SB53098

Science Learning Centers

Gr. 6–8 Engaging, ready-to-use learning center designed for teacher-directed instruction or independent learning working in a group of 2–4 students. Includes laminated, double-sided game board, game pieces, 30 illustrated self-checking question cards, and zippered storage pouch. Also includes 4 Visual Learning Guides with self-directed readings, easy-to-follow illustrated explanations, guiding questions, graphic organizers, and assessment review questions. For up to 4 students. **SB53097 Building Blocks of Life — \$35.95**
SB53098 Study of Heredity — \$35.95



NE30429

NE30430

NewPath Learning® Cell 3D Model Kits

Gr. 5–10 Colorful, easy-to-assemble model helps students learn about the main parts of an animal or plant cell. Each kit includes materials for 5 paper models for students working in groups. Includes NGSS-aligned teacher guide.
NE30429 Animal Cell (Blue) — \$34.95
NE30430 Plant Cell (Green) — \$34.95

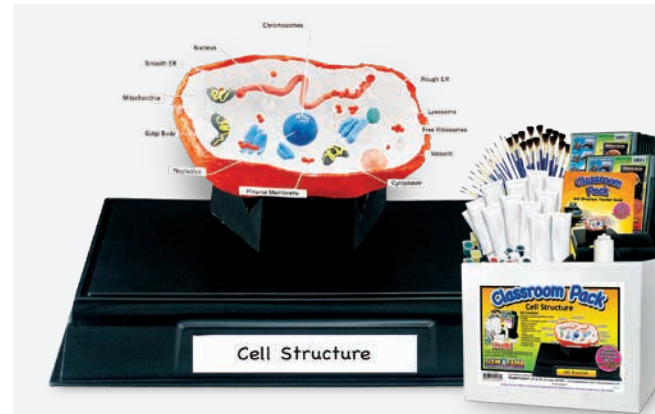

Cell Structure Classroom Pack

Gr. 3–8 Students will create their own cells in 5 sessions to reinforce the fundamental elements of any type of cell. Aids in meeting the expectations of the NSES for Life Sciences. For 12 individual or group projects.
SB45532 — \$119.95

BEST SELLER



4D Science™ Cell Complete Model Set

Gr. 5–8 Assemble models to better understand composition and structure of plant and animal cells. Each model features detailed parts and transparent outside for viewing internal structures. 16". **SB51409 — \$64.95**
Animal. 26 detachable parts. **SB49141 — \$35.95**
Plant. 24 detachable parts. **SB49142 — \$35.95**



ONLY AT NASCO

Nasco Cell Cycle Game

Gr. 7+ Calculate the possible mutations that may have occurred in an adult stem cell of a fictional character based on the outcomes of a narrative containing character's life choices, family history, and background. Correlates to CCSS and NSTA Standards.
SB51706 — \$62.95



Cell Model Set

Simple for elementary level, yet comprehensive enough for middle school. Made of resilient, nontoxic EVA foam. Includes animal and plant cell models listed below. Each hands-on model comes with a detailed teacher's guide including 5 inquiry-based lab activities, reproducible worksheets, assessment ideas, and more. **SB40956 — \$154.95**
Animal. Topics include cell structure and function, osmosis, eukaryotes, bacteria, and more. **SB31407 — \$85.95**
Plant. Topics include cell structure and function, osmosis, photosynthesis, pigments, and more. **SB31408 — \$85.95**

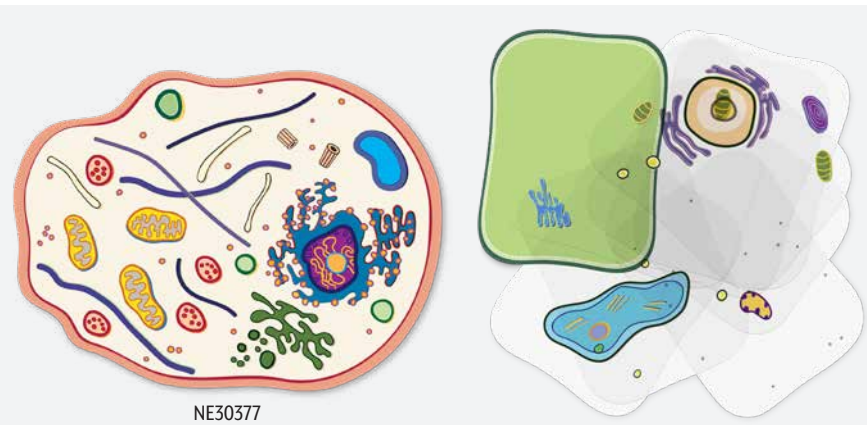

NE30377

NE30378

Rolyco® Cell Builders

Vibrant transparencies allow you to build the cell one layer at a time so you can focus on each organelle. The cell wall and membrane doubles as a clear tray that holds transparencies in place. Each kit includes tray and 9 transparencies.
NE30377 Animal Cell — \$14.99
NE30378 Plant Cell — \$14.99



Genetics I Kit

Become familiar with some human genetic traits and characteristics. Understand inherited differences.
C32877 — \$126.95

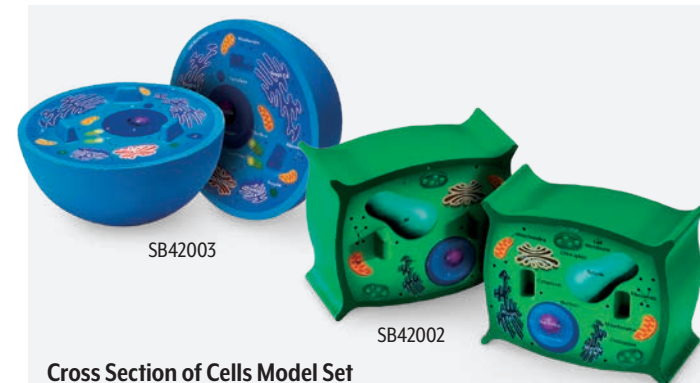

SB42003

SB42002

Cross Section of Cells Model Set

5" foam cross sections of a plant cell and an animal cell. One side in each cross section is labeled, the other side can be used for quizzes. Cross sections identify key organelles and their functions and comes with guide.
SB42004 — \$39.50
Cross Section Models
SB42003 Animal Cell (Blue) — \$21.00
SB42002 Plant Cell (Green) — \$21.00

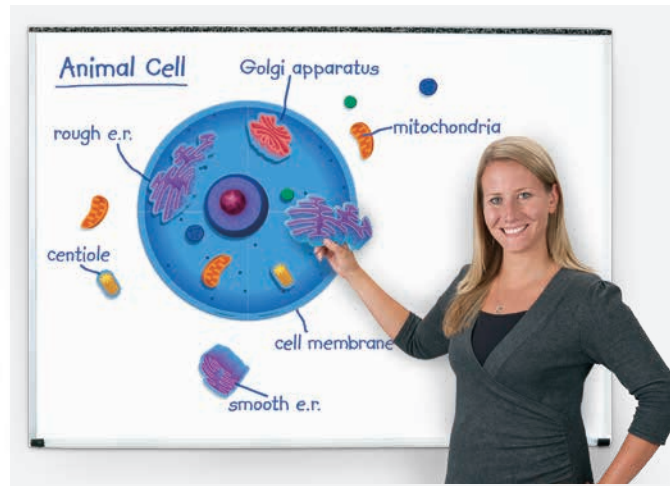

Magnetic Animal Cell Model

Cell structures are printed on raised foam magnet for a 3D effect. Coordinates with animal foam cell model to the left. Includes guide.
SB48210 — \$23.95



EXCLUDED FROM DISCOUNTS

Mitosis Manipulatives Kit
Demonstrate all 4 stages of the cell cycle with 66 oversized teacher manipulatives for use on a magnetic dry erase board, 5 sets (85 pieces) of smaller student manipulatives for a class of 30, detailed instructional CD, and activity manual.
SB49161 – \$390.00



Meiosis Kit
Includes 30 teacher demonstration chromosome models in 5 sets, 5 sets of smaller student models (17 manipulatives each), activity guide, CD, and teacher manual. Each set contains a maternal and paternal homolog and 4 sister chromatids. Alleles and parental lineage are clearly defined. Fifth set has removable alleles for demonstrating crossover.
SB47747 – \$390.00

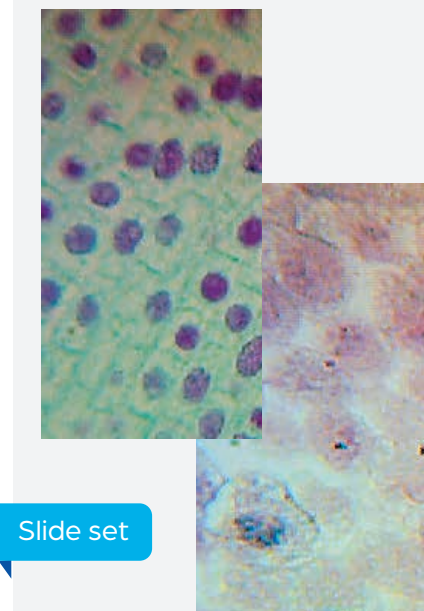

Slide set

Fish and Onion Mitosis Slide Set
Compare animal against plant mitosis. Allium (onion) slide shows root tip and all stages of mitosis present. Whitefish slide shows a section of blastodisc for animal mitosis demonstration. Set of 2.
SL10290 – \$22.25

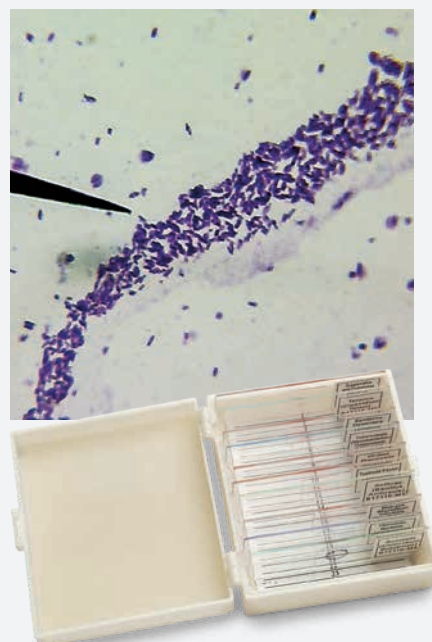

Deadly Human Diseases – Set of 10 Slides
Explore cellular structures and visible qualities of anthrax, tetanus, botulism, and more. Stored in a slotted plastic container.
SB52191 – \$76.00



Normal Mitosis Kit
Make stained microscope slides of a root tip that has been pooled to ensure students can observe cells undergoing mitosis. Students not only observe the presence of chromosomes in cells and the stages of mitosis, but also gain experience in microtechnique and staining. For 30 students.
⚠ CHOKING HAZARD (1). Not for under 3 yrs.
◆ SA08203 – \$248.95



Outbreak!
Gr. 6+ Simulation of how disease spreads. Documentation in the kit allows the teacher to substitute flu, hepatitis, or any other virus or bacteria as a causative agent. Ideal for biology, health, or family life courses. Enough material for 2 classes of 24 students working in pairs. No actual bacteria or virus is used in the simulation.
◆ SB46410 – \$73.80

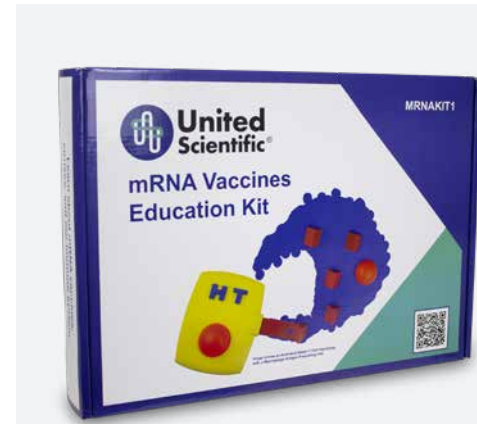

United Scientific mRNA Vaccines Education Kit
Gr. 9–12 Designed to aid in the teaching of how mRNA vaccines provide immunity against harmful viruses. Kit includes downloadable teaching resources and 35 plastic models representing cells and key structures, allowing students to simulate immune response to a virus.
NE30526 – \$77.50

NEW



Natural Selection and Antibiotic-Resistant Bacteria Kit
Models the effects of antibiotics on disease-causing bacteria. See how more resistant bacteria are selected if antibiotics are not taken properly. ⚠ CHOKING HAZARD (1). Not for under 3 yrs.
SB42898 – \$107.00



AIDS and STD Transmission and Control (A Simulation)
Illustrates how easily sexually transmitted diseases can infect teenage populations, as well as the permeability and effectiveness of latex barriers in preventing STDs. For 3 classes of 30 students working individually and in teams. ⚠ CHOKING HAZARD (1). Not for under 3 yrs.
◆ SB26208 – \$291.95



Glo Germ™ Kit
Nearly invisible in ordinary light, Glo Germ™ (fluorescent plastic particles) glow under UV light. Used as a graphic illustration to show where bacteria can hide, the Glo Germ™ powder and oil reveal areas most often missed in hand washing. Can be used to demonstrate cross contamination and surface cleaning. Kit includes a hand-held 21 LED ultraviolet flashlight (requires three AA batteries, included), an 8-oz. bottle of Glo Germ™ oil (approximately 75-100 demos), a 1.9-oz. bottle of Glo Germ™ powder (approximately 75-100 demos), and a translucent plastic case.
WA28161 – \$166.95

Glo Germ™ Kit. Identical to the kit above (WA28161), except with a 9 LED ultraviolet flashlight.
WA28160 – \$114.95

Glo Germ™ Powder. 4-oz. bottle (approximately 150-200 demos).
WA19097 – \$20.50

Glo Germ™ Oil. 8-oz. bottle (approximately 75-100 demos).
WA19096 – \$21.50

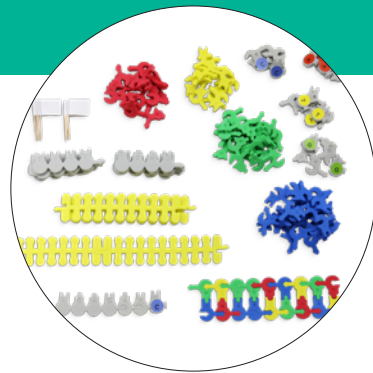
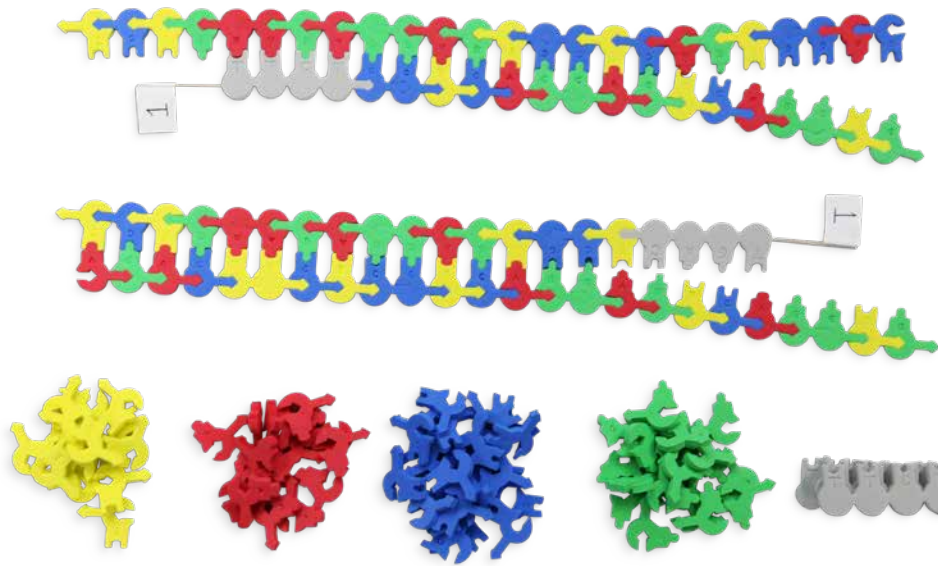

Biotechnology Kit

Gr. 6-12 With one, easy-to-deploy kit, your students will learn multiple biotechnology concepts, such as diagnostics, forensics, and bacterial transformation. Color-coded foam nucleotides allow students to model: polymerase chain reaction and how flanking primers result in the exponential amplification of a short product; the Sanger DNA sequencing method using chain-terminating fluorescent dideoxy nucleotide analogs; and DNA cloning using restriction endonucleases to cut DNA at specific sequences. Each kit serves 2-4 students.
NE30094 – \$115.00

Nasco Gram Stain Kit

Learn to differentiate between Gram-positive and Gram-negative microorganisms. Includes 30 ml each of Crystal Violet Solution, Gram's Iodine Solution, Alcohol/Acetone Solution, and Safranin (counter-stain) Solution.
SB30104 – \$29.95



BEST SELLER



A. Ready-To-Use Prepared Media

The most commonly used media for the culture of bacterial and fungal organisms. Sterile, dated media plate. 100 x 15 mm. 10 plates per unit. Shipped Monday through Wednesday only. Store at 2°-8° C.
Z13903 Nutrient Agar Plates – \$19.95
Z13905 Tryptic Soy Agar Plates – \$19.95

B. Student Bacteria Experiment Kit

Gr. 8+ Conduct bacteria experiments, including clean hands vs. dirty hands, dog mouth vs. human mouth, clean mouth vs. dirty mouth, and testing common items around the school or home. For individual experiments or can be used with 4 groups of 5-6 students.
SB39237 – \$46.95

Prepared Nutrient Agar Only. 200 ml.
SB51073 – \$13.95

C. Inoculating Loop

3"L, 25-gauge Nichrome wire with loop at one end. Other end mounted on 8" aluminum handle.
SB47542 – \$1.95

Kit includes everything you need to study bacteria



Introduction to Microbiology: Bacterial Growth and Staining

Gr. 7+ Sample and grow bacteria, then learn techniques for studying bacteria. Perform two staining techniques on bacterial cells to study morphology and to determine if collected bacteria are Gram-positive, Gram-negative, or both.
SB48225 – \$88.50

Separate and analyze DNA



EXCLUDED FROM DISCOUNTS

Edvotek® M36 Classroom DNA Electrophoresis Labstation

M36 HexaGel™ electrophoresis apparatus, 6 trays (7 x 7 cm), DuoSource™ 150 Power Supply (150V for 1 or 2 units), 2 fixed-volume mini pipettes (40 µl), micro pipette tips (1-200µl/2 racks of 96), and DNA fingerprinting classroom kit.
SB45632 – \$705.00

EXCLUDED FROM DISCOUNTS



Edvotek® M12 Dual Gel Electrophoresis Apparatus

Run the full spectrum of horizontal electrophoresis experiments. Two standard-length gel trays (7 x 7 cm) for experiments that require less separation, or 1 long gel tray (7 x 14 cm) for those that require more. For 1 or 2 groups. Also has 2 six-tooth combs, 2 tooth combs (8/10), and 4 rubber end caps.
SB45606 – \$225.00



Electrophoresis Stations Classroom Kit

Electrophoresis apparatus, power supply, 2 fixed 50 µL pipettors, and 2 racks of 96 universal tips (10-200 µL).
SB49183 – \$749.95

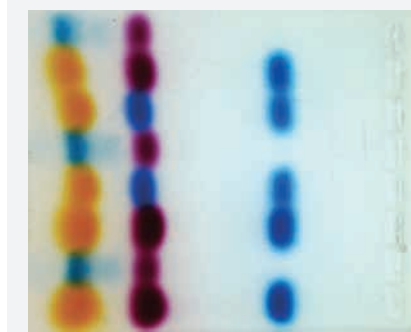

An Introduction to Electrophoresis

Identify unknown dye molecules by comparing their electrophoretic migration with the migration of known dyes, then identify dye molecules that bind to DNA and determine the mechanism. For 8 groups of students in 2 lab periods (40-60 minutes).
SB49181 – \$59.95



Agarose for Electrophoresis Stations and Units

Prepare your own agarose gels at any concentration with the addition of TBE running buffer. Can be stored at room temperature for years. Low EEO. 25 g.
SB51075 – \$60.95

The fun doesn't stop here!
Find more at nascoeducation.com



DNA Electrophoresis Labs and Simulations

Gr. 5+ For use with the DNA Electrophoresis Station (SB45632) on p. 53.

The Mystery of the Crooked Cell. Demonstrates detection of the mutation that causes Sickle Cell Anemia. Use electrophoresis to separate dyes that represent patient samples and controls. For up to 10 groups. 45-minute lab.

SB45630 — \$85.00

DNA Fingerprinting. Compare crime scene DNA with suspect DNA. For 8 groups. 60-minute lab.

*SB45631 — \$110.00

In Search of My Father. Solve the mystery of two boys separated from their parents a decade ago. Their biological mother is identified by mitochondrial DNA and their biological father from chromosomal DNA. For 10 groups. 45-minute lab.

*SB45636 — \$75.00

*EXCLUDED FROM DISCOUNTS



Whose DNA Was Left Behind?

Use dye simulations of two DNA samples from a crime scene to identify the criminal from four suspects. Requires an electrophoresis unit.

SB26186 — \$75.00

EXCLUDED FROM DISCOUNTS

CRACK THE GENETIC CODE
with DNA explorations



EXCLUDED FROM DISCOUNTS

DNA Fingerprinting by PCR Amplification

Uses PCR to amplify human DNA obtained from crime scenes. Required but not included: electrophoresis apparatus, white light box, and microwave or hot plate. For 8 gels; complete in 45 minutes.

SB53004 — \$107.00



Clear Acrylic Pipette Rack

Sleek pipe rack holds 5 pipettes. 11" x 6¼" x 5½"

SB47099 — \$33.95

EXCLUDED FROM DISCOUNTS



Ready-to-Load™ DNA: Detection of Mad Cow Disease

Examine simulated PCR products from several feed mills, to determine any possible violations of the 1997 ban that ended the practice of including animal parts in cattle feed. Contains enough materials and instructions for 6 gels (6 lanes each) with InstaStain® Blue or FlashBlue® stain.

C26406 — \$102.00

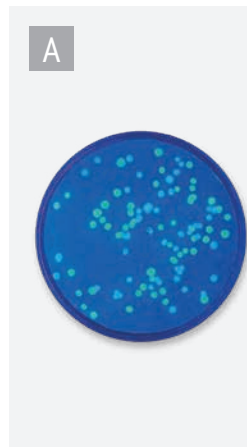

A. Transformation of E. coli with Green and Blue Fluorescent Proteins

Transform bacteria either with GFP, BFP, or both. Required but not included: water bath, 98.6° F (37° C) incubation oven, microwave or hot plate, and long-wave UV lamp. Some components require refrigeration and freezer storage. For 10 groups; complete in 50 minutes and grow overnight.

SB51180 — \$149.95



B. Pipette Tips

Nonsterile replacement tips for micropipettes and mini pipettes.

Micropipette Tips (1-200 µl), Yellow

SB46000 Bag of 1,000 — \$23.95

Micropipette Tips (100-1,000 µl), Blue

SB46001 Rack of 100 — \$12.95



C. Genes in a Tube™ Classroom Pack

Teach students how to extract and precipitate their own DNA. All you need is ice cold alcohol (95% ethanol or isopropyl alcohol) and a 56° C water bath. For up to 26 students. 30-minute lab.

SB45634 — \$140.00

EXCLUDED FROM DISCOUNTS



Do Onions, Strawberries and Bananas Have DNA? Kit

Make DNA models then extract DNA from onions, strawberries, or bananas. Required but not included: fruits or vegetables and 95-100% isopropyl alcohol. Time: 30 minutes. For 10 groups.

SB25276 — \$75.00

EXCLUDED FROM DISCOUNTS



Variable-Volume Fully Autoclavable Micropipettes

Built-in tip ejectors. Autoclavable tip cones. Works on a click-stop digital system. Easy to calibrate, maintain, and disassemble for autoclaving. Individually calibrated according to ISO 8655 standards (calibration certificate included).

20 µl. Volume range of 2-20 µl in increments of 0.1 µl. A volume of 2 µl is accurate to +/- 5%; a volume of 20 µl is accurate to +/- 1%.

SB51312 — \$139.95

50 µl. Volume range 5-50 µl in increments of 1.0 µl. A volume of 5 µl is accurate to +/- 2.5%; a volume of 50 µl is accurate to +/- 0.7%.

SB51313 — \$139.95

100 µl. Volume range 10-100 µl in increments of 1.0 µl. A volume of 10 µl is accurate to +/- 2.5%; a volume of 100 µl is accurate to +/- 0.8%.

SB51314 — \$139.95

FORENSIC SCIENCE

Forensics is a great way to draw students into making scientific inquiries. Through hands-on lessons and high-interest scenarios, they will apply critical-thinking and problem-solving skills to find evidence and crack a case.

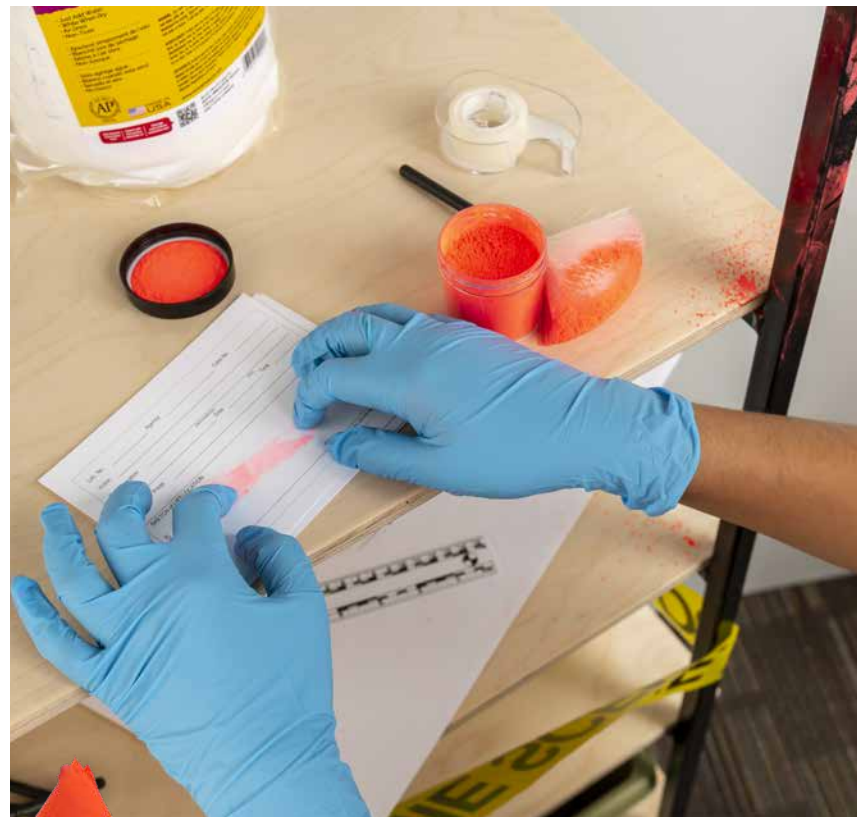

Get 12 engaging experiments in one convenient bundle!



ONLY AT NASCO
EXCLUDED FROM DISCOUNTS

Includes digital guide

Don't miss NEW fingerprinting items on p. 62!



Nasco CSI Forensics Classroom Kit
Gr. 5–8 Immerse students into scenarios such as a classroom break-in, interrogation, and vending machine caper. Perform fingerprinting, simulated blood patterns, fabric testing, plaster casts, and more. For 24 students. ⚠️ CHOKING HAZARD (1,2). Not for under 3 yrs.
SB52385 – \$615.00

Innovating Science® Forensic Science Lab Activities - Complete Set of 12
Gr. 6–12 Introduce your students to the basics of forensic investigation with this set of 12 lab activities. Students will work with several different types of possible evidence, such as fingerprints, blood, and gunshot residue. Each kit contains materials for 15 groups of students. ⚠️
◆ NE30422 – \$780.00

Innovating Science® Forensics Mastery Set
Gr. 6–12 Get all the materials needed to introduce students to the forensic analysis of hair, fingerprints, soil and minerals, drugs and poisons, and documents. Includes 5 kits, teacher's guide, and student study guide copymasters. Contains materials for 30 students working in groups. ⚠️
◆ NE30423 – \$668.00



Complete Crime Scene Set
Fascinating fictional scenarios allow students to solve mysteries and prevent crimes. Includes one of each kit listed.
◆ SB51268 – \$289.95

Crime Scene 1: Lois McArthur. Gr. 7+ Look for a culprit in a mock murder case. For 2 classes of 24 students working in pairs to perform hair, fiber, blood, handwriting, and fingerprint tests.
◆ SB28531 – \$79.95

Crime Scene 2: Kidnapped! Gr. 6+ Investigate a kidnapping to uncover a missing heir. Perform blood, fiber, paper, ink, and fingerprint analysis tests. For 3 classes of 24 students working in pairs.
◆ SB42186 – \$79.95

Crime Scene 3: Drug Bust! Gr. 6+ Solve a series of drug-related crimes. For 3 classes of 24 students working in pairs.
◆ SB42185 – \$79.95

Crime Scene 4: Terror from Paradise. Gr. 8+ Students must thwart a terrorist plot by performing customary terrorism detection tests. For 3 classes of 24 students working in pairs.
SB51267 – \$79.95

Summer Camp Kit



Z51518

Rogue Rodent Mystery: A Study in Forensic Science

Gr. K-1 Students work together to determine which of 4 suspects stole Alice the guinea pig from her classroom. Lessons have students investigate the crime scene, interview suspects and witnesses, examine evidence, and more. 10 lessons; approximately 1 hour each. For 30 students.

Summer Camp Kit. Includes 103-page instructor's guide, introductory video on DVD, teacher resource CD, preprinted student handouts, and all needed supplies.

Classroom Kit. Includes 103-page instructor's guide, introductory video on DVD, teacher resource CD, and essential supplies.

Z51518 — \$749.00

Missing Money Mystery: A Study in Forensic Science

Gr. 2-3 Work to solve the mystery of the stolen funds and determine the guilty party. Lessons have students collect evidence from the crime scene and examine evidence using real forensic techniques such as forensic fiber analysis, lifting lip prints, and exploring genetic markers. 12 lessons; approximately 1 hour each. For 30 students.

Summer Camp Kit. Includes 107-page instructor's guide, teacher resource CD, preprinted student handouts, and all needed supplies.

Classroom Kit. Includes 107-page instructor's guide, teacher resource CD, preprinted student handouts, and essential supplies.

Z51519 — \$749.00



Who Stole the Gold? Comprehensive Forensic Analysis

Gr. 9+ Students help figure out which of 4 suspects is responsible for stealing the gold by analyzing soils, minerals, documents, fabrics, fibers, blood, fingerprints, and hair. For 15 groups.

◆ SB51979 — \$176.00

Classroom Kit

EXCLUDED FROM DISCOUNTS



ELI6549

Cookie Jar Mystery: A Study in Forensic Science

Gr. 4-5 Students will examine and analyze forensic evidence to solve the mystery of the broken cookie jar. Facilitates scientific observation, sample examination, analysis, lab work, testing, and more. 12 lessons, approximately 1 hour each. For 30 students.

Summer Camp Kit. Includes 110-page instructor's guide, teacher resource CD, preprinted student handouts, and all needed supplies.

Classroom Kit. Includes 110-page instructor's guide and essential supplies.

Z51520 — \$749.00

NEW



Kemtec™ Criminalistics Kit

Gr. 5-12 Using microscopes, measurement, chemical analysis, observation, and deductive reasoning, students use CSI techniques to solve the murder of Mr. Paul Dudden. For 24 students. Full supplies list online. Meets NGSS.

◆ NE30591 — \$603.00



The Case of the Lost Skull

Gr. 5-8 An animal skull has been found with money stuffed inside and potential evidence in the area. Students analyze fingerprint, blood, hair, fiber, imprint, and documentation evidence over the course of 5 days. For 30 students. Requires a microscope (not included).

SB42519 — \$224.95

BEST SELLER



The Case of the Missing Mascot

Gr. 5-8 Left at the scene is a note, leaves, a mouth guard, and white fibers. Investigations include analyzing DNA results; using dichotomous keys to identify selected plants; analyzing handwriting, fingerprints, and bite marks; and a fiber flame test. For 30 students.

SB42521 — \$224.95



NE30420

Innovating Science® Forensic Case Study: Drugs - Small Town, Big Problem

Gr. 6-12 In this activity, students must assist the police in identifying an illicit drug distributor by analyzing a variety of forensic evidence, including fingerprints, unknown powders, urine specimens, and more. Kit contains materials for 15 groups of students. Includes teacher's guide and student analysis copymasters.

◆ NE30420 — \$87.00



NE30421

Innovating Science® Forensic Case Study: Murder at Eagle Nest Harbor

Gr. 6-12 Students take on the role of a forensic technician as they analyze hair, fiber, fingerprint, blood, and handwriting evidence to help identify a murderer. Kit contains materials for 15 groups of students. Includes teacher's guide and student guide copymasters.

NE30421 — \$99.95

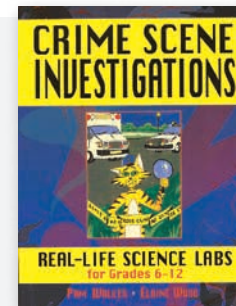

Crime Scene Investigations

Gr. 6+ Solve crimes ranging from check forgery to murder. 68 lessons with teacher background info and activity sheets. 288 pages.

SB39171 — \$39.95

The Case of the Kidnapped Cookies

Gr. 5-8 Figure out which staff members took the cookies. Clues include a stained ransom note with envelope, white powder, and soil. For 30 students. Requires a microscope (not included).

SB42523 — \$224.95



BEST SELLER



Forensic Toxicology
Gr. 6+ Students will use different lab techniques to determine the presence of alcohol, drugs, and pain medications in the simulated urine samples of suspects. Includes teacher's manual and student study guide copy-masters. Enough materials for 30 students.
SB53066 – \$154.00



Forensic Chemistry: Hair Analysis
Gr. 6+ Discover how forensic scientists use hair to assist in solving crimes. For 15 groups.
SB43606 – \$80.95

BEST SELLER



Forensic Science: Introduction to DNA Fingerprinting
Gr. 4–8 Begin with a crime scene, an eyewitness report, and “video stills,” then construct a model of a “chromosome” with color-coded “genes” representing some physical traits of the suspects. 5 activities. For 15 groups of 2. Materials are reusable. **CHOKING HAZARD (I)**. Not for under 3 yrs.
SB27541 – \$286.55



Odontology (Bite Out of Crime)
Gr. 9+ Learn how dental records are used as a form of positive identification with these 7 experiments. Meets National Standards for grades 9–12. **CHOKING HAZARD (I)**. Not for under 3 yrs.
SB47538 – \$427.95



Kemtec™ Analysis of Drugs & Poisons Kit
Gr. 9+ Identify some common over-the-counter drugs, learn test procedures for “controlled substances,” and analyze simulated body fluids, such as urine. **CHOKING HAZARD (I)**. Not for under 3 yrs.
SB49875 – \$284.95



Forensics Using Simulated Blood
Gr. 7+ Students first use a blood test to determine if a substance on a stained piece of cloth may be blood, and then determine the blood type of a sample collected. Students compare their results to samples provided from 2 suspects. For 10 groups.
SB48260 – \$70.95

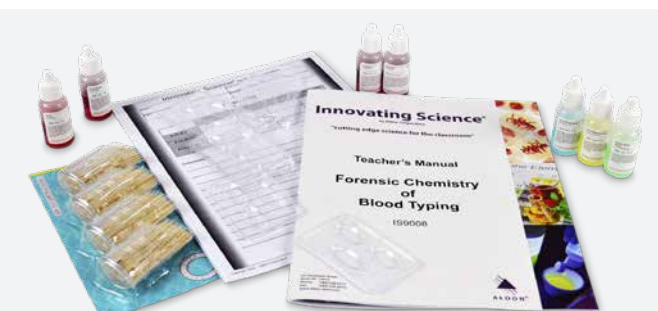

Forensic Chemistry of Blood Types
Gr. 6+ Determine blood type of 4 simulated samples (victim, suspect #1, suspect #2, and crime scene) to figure out whodunit. For 15 groups.
SB43607 – \$60.95



Innovating Science® Forensic Analysis of Fabric and Fibers Kit
Gr. 5+ Introduce students to fabric and fiber analysis with experiments covering cloth weave identification, microscopic fiber analysis, burn testing, and chemical analysis. For 10 groups.
EL15811 – \$152.00



Contamination of Carter Creek Environmental Forensics Kit
Gr. 6+ The creek near a paper and plastics business has been polluted. Find the nature of the contamination and locate its source. For 24 students working in pairs.
SB50011 – \$74.95



Forensic Drug and Poison Analysis: Chemistry and Toxicology
Gr. 9+ Perform chemical tests on drugs and poisons, identify unknown samples based on test results, and examine urine for evidence of heavy metal poisoning using chromatography. For 15 groups.
SB51984 – \$204.75
Refill (Chemicals Only)
SB51985 – \$152.95



Innovating Science® DNA Extraction Individual Student Science Kit
 Help students learn a little about the discovery of DNA and DNA structure while they discover the nature of genetic inheritance and the role of DNA and proteins in genetic expression. Great option for distance learning or in no-share classroom environments.
How it works:
 • Students will use biological detergents, enzymes and ethanol to isolate DNA from plant material you supply
 • Kit includes enough materials to run the experiment twice or for 2 students to use and an instruction manual
NE30072 – \$9.50



Innovating Science® Chemiluminescence in Blood Stain Detection Forensic Kit
Gr. 6–8 Use this forensic kit to show students how luminol is used in crime scenes every day. Special luminol formula does not require a separate catalyst. Rehydrate and use with the simulated blood hemoglobin. Kit contains materials for several demonstrations. Includes NGSS-aligned teacher guide.
NE30419 – \$31.00

See page 3 for complete Choking Hazard Label Information.

DOT hazardous material Subject to DOT hazardous material surcharge.



Nasco Latent Fingerprint Kit and Poster Set

Illustrates the 3 main fingerprint patterns (whorl, arch, and loop) with 3 laminated posters (11" x 16½" each) and 3 double-sided TearPads™ (50 sheets, 8½" x 11" each). Also includes latent fingerprint kit. **SB52384 – \$83.95**

ONLY AT NASCO

Latent Fingerprint Kit Only. Includes 2 oz. bottle of bichromatic magnetic fingerprint powder, magnetic powder applicator brush, 1½" x 360" roll of clear fingerprint lifting tape, and a pad of 100 glossy 3½" x 5" latent print backing cards. Comes in a sturdy, protective carrying case. **SB51457 – \$54.95**

Nasco Magnetic Fingerprint Kit

Includes 1-oz. bottle of bichromatic magnetic fingerprint powder, magnetic powder applicator brush, 360"L x 1½"W roll of clear fingerprint lifting tape, 2-oz. clear specimen jar with cap, and a pad of 100 glossy 3½" x 5" latent print backing cards. **SB51456 – \$59.95**

Fingerprint Lifting Tape Only. Lifts powdered fingerprints. 360" x 1½" roll. **SB51379 – \$11.95**



NEW

Latent Print Cards

Lift fingerprints with tape and mount them on the glossy side. Use non-glossy side for case information and a sketch of the recovery location of the print. Use with black powder. 3" x 5". 100 white cards. **NE30517 – \$15.00**



Fingerprint Brushes

For use with regular (non-magnetic) fingerprint powders of all colors. Comes in clear plastic tube with cap.

A. Regular. Soft, high-grade goat hair. Bristle length 1¼", overall length 6¼". **SB51372 – \$9.00**

B. Latent Plus. Non-abrasive brush with soft fiberglass bristles. **SB51376 – \$11.95**

NEW

C. Fiberglass Fingerprinting Brush

Made of thousands of glass fibers and holds more powder than traditional hair brushes. Works with all latent powders. Includes storage tube. **NE30518 – \$15.00**

D. Forensic Science Latent Fingerprint Powders

High-quality latent fingerprint powders used by experts. 1 oz. Black. **NE30613 – \$9.50**



Whose Fingerprints Were Left Behind? Experiment Kit

Gr. 6+ Use latent prints and a UV light source in a "whodunit" activity. Required but not included: alcohol, UV long wave light source (mineral light), safety goggles, and a towel or washcloth. 50 minutes. For 10 lab groups. **SB39287 – \$80.95**

EXCLUDED FROM DISCOUNTS

NEW

Crime Scene® Fingerprint Cards - Pack of 50

Cards are form No. FD-258 version: 11-1-20 used by the FBI, Bureau of U.S. Citizenship and Immigration Services, and police agencies for noncriminal fingerprinting. Pack of 50. **NE30521 – \$16.95**



NEW

Fingerprinting Ink Pad

Ink dries almost instantly, preventing smudging or smears. Fingerprints produced will meet all state and federal requirements. Average 1,000 prints. No special hand cleaners required. 1.5" pad. **NE30519 – \$14.75**



NEW

Magnetic Fingerprint Powder Applicator

Powerful magnet holds large amount of magnetic powder. Spring-loaded handle holds internal magnet forward, allowing dusting at overhead angles. Pull to release. Hexagonal lip prevents applicator from rolling. 5.5"L. **NE30523 – \$27.00**



Clear Evidence Jars

Clear plastic jars with tight-fitting, lined screw-top lids.

Product No.	Volume	Each
SB51385	2 oz.	\$1.00
SB51386	4 oz.	\$1.50
SB51387	8 oz.	\$2.15

NEW

Paper Evidence Bags

Paper evidence bags feature an area to list the chain of custody. Pack of 100. **NE30515** Small, 5½" x 3¼" x 9½" — \$40.00 **NE30516** Medium, 7" x 4" x 13½" — \$48.50

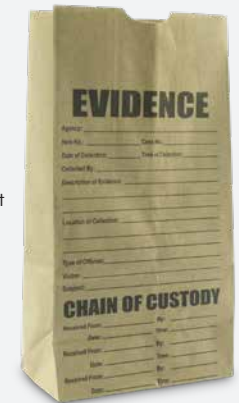

NEW

Crime Scene® Evidence & Chain of Custody Labels

Affix to any virtually surface to identify and maintain a chain of custody on collected evidence. 3½" x 6". Pack of 100. **NE30514 – \$22.00**



See p. 162 for forensic gloves



Crime Scene Barricade Tape

Comes in dispenser box. 1,000' x 3". **SB49303 – \$29.95**

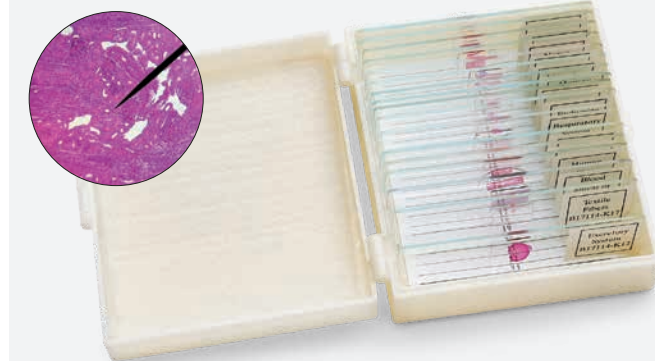

Forensic Slide Set

17 prepared, labeled slides include digestive system, connective tissue, human blood, nerve tissue, and more. Store in slotted plastic container. **SB52190 – \$41.95**

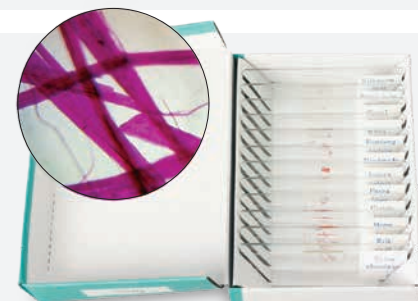

Textile Fibers Slide Set – Student Grade

Includes 12 prepared 3" x 1" glass slides featuring stained specimens studied in life science. Cotton fibers, hemp fibers, nylon fibers, wool fibers, silk fibers, sheep hair, and 6 other specimens. Subjects in set may change. **SL10007 – \$27.95**



Hair Types Slide Set

Samples from humans and animals including dog, w.m.; deer, w.m.; horse, w.m.; human, 3 colors, w.m.; mouse, w.m.; cat, w.m.; woolly mammoth, w.m.; hair, 3 types (human, cat, sheep), w.m.; human, 3 types (straight, curly, gray). Set of 9. **SB51053 – \$23.95**

Osteometric Board

Gr. 9+ Lightweight styrene measuring board with slider and 60 cm scale. Bone not included. **SB52129 – \$76.95**



DISSECTION

Dissection offers plenty of hands-on opportunities to see, touch, and explore the inner systems of preserved specimens firsthand.

As your students use dissection materials and tools in the lab, they may be inspired to pursue careers in medicine, veterinary care, biology, and more.

Specimens **65–78**
Tools **79–82**
Supplies **83**

Check out our "Try It" Kits on p. 66!



THE SAFEST DISSECTIONS START HERE

ONLY AT NASCO

Every specimen in this catalog has been prepared with NASCOGuard® – our nontoxic, low-odor humectant fluid that exceeds OSHA standards

Nasco Preserved Specimens
Featuring NASCOGuard®

99.7% formaldehyde free

Our skilled technicians remove the original formaldehyde fixative in a series of water baths, then perfuse the specimens with propylene glycol to inhibit the growth of decay organisms, ensure moist specimens, and lower the vapor pressure of any residual formaldehyde.

Shelf life guaranteed indefinitely

NASCOGuard® specimens will remain usable indefinitely when stored in the original sealed packaging, so you can be confident of consistent results with expertly preserved specimens.

Three levels of color-coding

Key structures are injected with colored latex for clear and visible differentiation of organs and structures, providing an enhanced learning experience.



Single injection

• Arteries shown in red



Double injection

• Arteries shown in red • Veins shown in blue



Triple injection

• Arteries shown in red • Veins shown in blue • Hepatic portal system in yellow

200+ premium-quality specimens

We obtain our specimens through professional collectors, by-products of stockyards, and the food industry. All of these are processed and packaged by skilled technicians in our Wisconsin facility. We're licensed and/or governed by the U.S. Fish and Wildlife Service, the U.S. and Wisconsin Department of Agriculture, and the Wisconsin Department of Natural Resources.

BEST SELLER

A crime scene twist on traditional pig dissection!

ONLY AT NASCO



Nasco Cause of Death Autopsy Kit

Students will follow the steps a medical examiner would take as they conduct an authentic forensic autopsy. A complete activity guide will take students through step-by-step instructions of the medical examiner process. The 3 fetal pigs represent victims with stab wounds, gunshot wounds, or a broken back. Use the scientific method in real-life applications as your students investigate the demise of the pigs. Kit includes three 10" to 13" pigs, suture needle, nylon thread, data cards, bags, and a complete activity guide.

LS03825 – \$185.00

Refill Kit. 3 pigs and data cards.
LS03825(CB) – \$125.00



HOW TO STORE AND DISPOSE OF YOUR NASCO PRESERVED SPECIMENS

When your specimens arrive, keep them at room temperature and in the shipping bag/container they came in until you are ready to use them. Between classroom sessions, return specimens to a tightly closed plastic bag or airtight container to prevent them from drying out. If specimens begin to dry out over the course of an extended dissection, re-moisten them with NASCOGuard® Humectant Fluid only (see right).

Specimens are biodegradable, so once the dissection is complete, they can be buried in an approved sanitary landfill or incinerated. Ambient fluids may be safely disposed via city sewers.

NASCOGuard® Humectant Fluid
⚠ CHOKING HAZARD (1). Not for under 3 yrs.

Five 1-Gallon Bottles
SB17218 – \$93.00

1-Gallon Bottle
SB12631 – \$20.75

1-Quart Bottle
SB32395 – \$11.50

1-Pint Bottle
SB32396 – \$9.00



⚠ See page 3 for complete Choking Hazard Label Information.

CONVENIENT, ALL-IN-ONE KITS

Give each student their own specimen, set of dissection tools, and protective equipment

Nasco "Try It" Dissection Kits

Introduces students to the exploration of internal and external anatomy of a specimen. Each kit is equipped with a preserved specimen, dissection tools, a plastic apron, an illustrated guide, and latex-free gloves. Dissection tray not included.

Fetal Pig. 7"-10" plain fetal pig.
LS03815 - \$44.95 10+ \$40.45

Crayfish. 4"-6" plain crayfish.
LS03852 - \$18.95 10+ \$17.05

Rat. Fully mature, 7"-9" plain rat.
LS03848 - \$29.95 10+ \$26.95

Worm. 2 single injected worms (8"+).
LS03853 - \$20.95 10+ \$18.85

Perch. 7"+ plain perch.
LS03849 - \$20.95 10+ \$18.85

Squid. 8"-12" plain squid.
LS03854 - \$22.95 10+ \$20.65

Frog. 4"-4½" plain frog.
LS03850 - \$23.95 10+ \$21.55

Cow Eye
LS03859 - \$17.95 10+ \$16.15



LS03854



Plain Single injection

Earthworms (Lumbricus terrestris)

Earthworms are great for beginners and advanced students. These can be ordered with the circulatory system red (injection) or plain. Residual fluid is added to the sealed bag for long-term storage.

Product No.	Size	Injection	Qty.	Each	10+
LS02407	8"-10"	Plain	10	\$10.50	\$9.45
LS01081	8"-10"	Single	1	\$6.70	\$6.02



Grasshopper Classroom Pack

Includes 30 grasshoppers (3 units of LS01319) and 30 grasshopper dissection guides (SB07317). Each student receives a dissection guide to further explain external and internal anatomy to work independently, in pairs, or groups.

Grasshoppers

Product No.	Type	Size	Injection	Qty.	Each	10+
LS01319	(Romalea microptera)	Large	-	10	\$8.75	\$7.87
LS02440	(Romalea microptera)	Large	Tracheal system - yellow	10	\$12.75	\$11.47
LS03477	(Brachy-stola magna)	Large	-	10	\$9.00	\$8.09

Nasco Zoology Survey Set with Study Guides, Preserved

Includes 1 each of earthworm, crayfish, clam, grasshopper, sea star (starfish), perch, and grass frog.

LS03737 With Dissection Guides - \$24.95 10+ \$19.31
LS02893 Without Dissection Guides - \$16.95 10+ \$15.78

Nasco Individual Guide Set. Includes a guide for each specimen listed above. Set of 7.
SB23166 - \$13.95



LS03737



Sandworm/Clam Worm (Nereis)

Large, 8"+. 10+ \$3.37
LS01292 - \$3.75

Set of 30 guides



Earthworm Classroom Kit

Includes 30 earthworms (8"-10", LS02407) and 30 earthworm dissection guides (SB07316).
LS03719 - \$54.00

Sponge Spicule Lab Activity

Gr. 9+ Dissolve spongein to analyze and identify the remaining spicule. Six species of sponges, each with a unique spicule type; enough tissue for 80 students working in pairs; and written procedure and student worksheet.

SB51342 - \$45.95



Unit of 10

Pig Roundworm (Ascaris suum)

Unit of 10. Mixed sex. Length will vary, but average size is 9".
LS01071 - \$26.95



Nonvenomous Snake

20" average (50 cm). Species as available.
LS01422 - \$25.95 10+ \$23.35

EXPLORE UNDERWATER ADAPTATIONS

From fins to scales to claws and everything in between



Grey Perch (Pomadasys Macracanthus)

Product No.	Size	Injection	Qty.	Each	10+
LS03690	9"-12"	Plain	1	\$6.75	\$6.07
LS03689	7"-9"	Plain	1	\$3.55	\$3.19
LS03691	5"-7"	Plain	1	\$2.55	\$2.29



Lamprey (Petromyzon or Entosphenus)

Product No.	Size	Injection	Qty.	Each	10+
LS02460	18"+ (46+ cm)	Plain, large	1	\$14.00	\$12.60
LS03744	18"+ (46+ cm)	Single injected, large	1	\$14.50	\$13.05
LS02465	18"+ (46+ cm)	Double injected, large	1	\$17.00	\$15.30
LS03697	Under 18" (46 cm)	Plain, small	1	\$13.00	\$11.70



Grey Perch Classroom Kit

Includes 30 grey perch (7"-9", LS03689) and 30 perch dissection guides (SB07313), to allow each student to have their own dissection guide. **LS03778 - \$104.00**



Crayfish (Cambarus)

Product No.	Size	Injection	Qty.	Each	10+
LS01314	4"-6"	Plain	1	\$2.75	\$2.47
LS02428	4"-6"	Single	1	\$4.65	\$4.18
LS02952	3"-4"	Plain	1	\$2.25	\$2.02



Green Sea Urchin

(Strongylocentrotus sp.)
Large, 2" (5 cm) average.
LS02405 - \$6.75 10+ \$6.07



But wait, there's more! Scan to browse the full selection of dissection specimens at **nascoeducation.com**

Shark

Depending on availability, specimens may be either squalus dogfish or mustelus smooth-hound sharks.

Product No.	Size	Injection	Qty.	Each
LS03585	27" +	Plain	1	\$31.00
LS03586	27" +	Double	1	\$33.50
LS03587	27" +	Triple	1	\$34.50
LS02467	22"-27"	Plain	1	\$20.00
LS02469	22"-27"	Double	1	\$22.00
LS02470	22"-27"	Triple	1	\$24.50
LS03575	18"-22"	Plain	1	\$15.95
LS03588	18"-22"	Double	1	\$18.95
LS01348	Shark Head	Long cut	1	\$11.50



LS03587



LS01348



Squid (Loligo)

Learn the functions and structures of the squid, a perfect specimen for studying class cephalopoda. Order our dissection guide (SB18116) for step-by-step instructions to assist with this dissection.

Product No.	Size	Injection	Qty.	Each	10+
LS01302	12"-16"	Plain	1	\$11.15	\$10.03
LS02420	12"-16"	Single	1	\$13.95	\$12.55
LS01304	12"-16"	Double	1	\$16.95	\$15.25
LS02421	8"-12"	Plain	1	\$9.50	\$8.54
LS02422	8"-12"	Single	1	\$11.25	\$10.12
LS03574	5"-8"	Plain	1	\$5.50	\$4.94

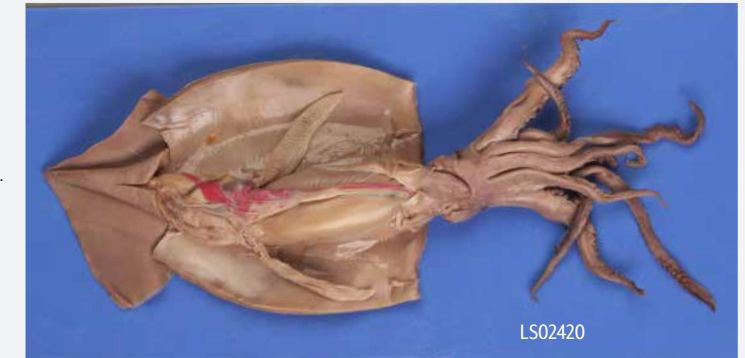

LS02420



Octopus (Octopus bairdi)

Small 2"-5" (5-12 cm). **LS01303 - \$20.95 10+ \$18.85**



Skate (Raja)

Medium/large, plain preserved. **LS03480 - \$16.95 10+ \$15.25**



Clam Classroom Kit

This kit includes 30 clams (4"-5", LS01083) and 30 Clam Dissection Guides (SB07320). Each student receives a guide to further explain the anatomy to work independently, in pairs, or groups. **LS03718 - \$128.00**

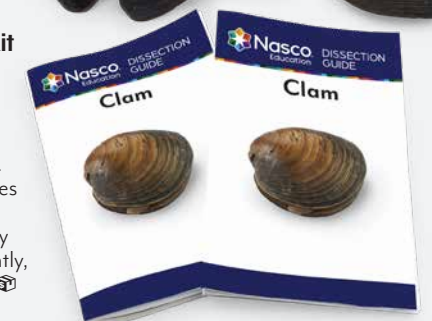

Product No.	Type	Size	Qty.	Each	10+
LS03464	Freshwater Clams (<i>Unio</i> or <i>Anadonta</i>)	3"-4"	1	\$2.95	\$2.65
LS01083	Freshwater Clams (<i>Unio</i> or <i>Anadonta</i>)	4"-5"	1	\$3.75	\$3.37
LS02416	Marine Quahog (<i>Venus mercenaria</i>)	3"-5"	1	\$4.10	\$3.69



LS03712

Grass Frogs (Rana sp.)

Product No.	Size	Injection	Qty.	Each	10+
LS03712	4½"-5½"	Plain	1	\$11.50	\$10.34
LS03713	4½"-5½"	Single	1	\$12.00	\$10.80
LS03714	4½"-5½"	Double	1	\$12.50	\$11.24
LS03715	4½"-5½"	Triple	1	\$13.00	\$11.70
LS02492	4"-4½"	Plain	1	\$7.50	\$6.74
LS02494	4"-4½"	Single	1	\$9.00	\$8.09
LS02496	4"-4½"	Double	1	\$9.55	\$8.59
LS02497	4"-4½"	Triple	1	\$10.55	\$9.49
LS01373	3"-4"	Plain	1	\$4.85	\$4.36
LS02493	3"-4"	Single	1	\$5.85	\$5.26
LS02495	3"-4"	Double	1	\$6.55	\$5.89

Frog Classroom Basic Kit

30 frogs (4"-4½", LS02492) and 30 Frog Dissection Guides (SBI0258), allows each student to have their own dissection guide. **LS03724 – \$210.00**

Frog Classroom Standard Kit

Includes Basic Kit above (LS03724), plus 30 disposable dissection trays (9¼" x 11¼", SB41945, see p. 82). **LS03724(A) – \$217.00**

Frog Classroom Deluxe Kit

30 sets of dissection tools/instruments (SBI2623, see p. 79), 30 preserved 3"-4" frogs (LS01373), 30 Frog Dissection Guides (SBI0258), and 30 magnifiers (SBI8007, see p. 97). **LS03749 – \$408.00**



LS01363

Bullfrogs (Rana sp.)

Product No.	Size	Injection	Qty.	Each	10+
LS02503	6"-7"	Plain	1	\$18.75	\$16.87
LS01362	6"-7"	Single	1	\$21.75	\$19.57
LS01363	6"-7"	Double	1	\$23.50	\$21.15
LS02509	6"-7"	Triple	1	\$25.75	\$23.17
LS02502	5"-6"	Plain	1	\$16.50	\$14.85
LS01365	5"-6"	Single	1	\$17.25	\$15.52
LS01366	5"-6"	Double	1	\$19.50	\$17.54
LS02508	5"-6"	Triple	1	\$21.50	\$19.34

Bullfrog Classroom Kit

30 bullfrogs (5"-6" plain, LS02502) and 30 Frog Dissection Guides (SBI0258), allows each student to have their own dissection guide. **LS03824 – \$425.00**



Nasco Frog Dissection Guide Set

Well-illustrated guide provides step-by-step instructions for the dissection of this common laboratory specimen. Classroom tested and proven to assist the student with self-guided instruction. Set of 15, 5½" x 8½". **SBI0258 – \$21.95**



Rats

Product No.	Size	Injection	Qty.	Each	10+
LS03709	9"+	Plain	1	\$19.75	\$17.77
LS03576	9"+	Double	1	\$25.95	\$23.35
LS03577	9"+	Triple	1	\$27.95	\$25.15
LS01436	7"-9"	Plain	1	\$14.25	\$12.82
LS01437	7"-9"	Single	1	\$20.00	\$17.99
LS01438	7"-9"	Double	1	\$22.00	\$19.80
LS02523	7"-9"	Triple	1	\$23.95	\$21.55

Rat Classroom Pack

Includes 30 rats (7"-9" plain, LS01436) and 30 Rat dissection Guides (SB29846), allows each student to have their own dissection guide. **LS03763 – \$430.00**



Mouse

Plain, preserved. Sexually mature. **LS01433 – \$4.75 10+ \$4.27**

Sparrows and starlings available at nascoeducation.com



Pigeons

Product No.	Size	Injection	Qty.	Each	10+
LS02667	Adult	Plain	1	\$15.95	\$14.35
LS02668	Adult	Single	1	\$18.50	\$16.64
LS02019	Adult	Double	1	\$23.95	\$21.55
LS02669	Adult	Triple	1	\$24.25	\$21.82



Frog Anatomy Aprons

Anatomically correct, lightweight, and disposable. 3 mil polyethylene. Aprons do not protect from harsh chemicals. Box of 100. **SB32571 – \$95.95**



LS02660

Turtles

Turtle species are either *Chrysemys* or *Trachemys*. Single-injected turtles have red latex injected into arterial system. Double-injected turtles also have blue latex injected into ventral abdominal, hepatic portal, and renal portal vein. Triple-injected turtles also have yellow latex injected into pre- and post-caudal veins.

Product No.	Size	Injection	Qty.	Each	10+
LS02660	8"-10"	Plain	1	\$21.00	\$18.89
LS02662	8"-10"	Single	1	\$24.00	\$21.60
LS02663	8"-10"	Double	1	\$27.00	\$24.29
LS02664	8"-10"	Triple	1	\$29.75	\$26.77
LS02657	6"-8"	Plain	1	\$19.50	\$17.54
LS03487	6"-8"	Double	1	\$22.95	\$20.65

ALTERNATIVES TO THE CAT

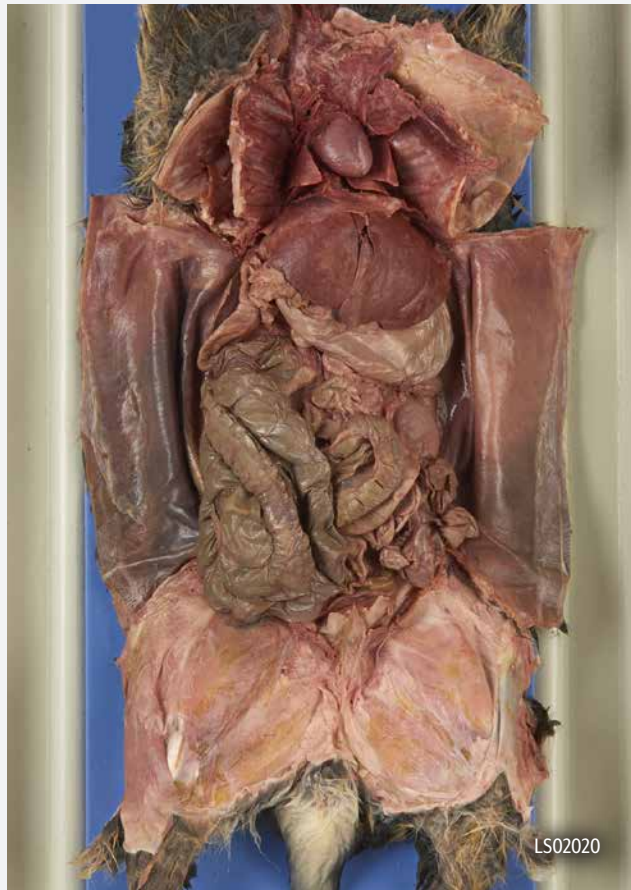

LS02020

Rabbits

Product No.	Size	Injection	Qty.	Each	10+
LS02518	Large	Plain	1	\$64.50	\$58.04
LS02519	Large	Single	1	\$70.00	\$62.99
LS02020	Large	Double	1	\$72.95	\$65.65
LS02520	Large	Triple	1	\$80.00	\$71.99



LS01963

Mink (Descented)

Readily available, well-muscled, and measures 13"-17" (34-44 cm). Specimens are skinned with scent glands and external abdominal fat removed.

Product No.	Size	Injection	Qty.	Each	10+
LS02022	13"+	Plain	1	\$24.95	\$22.45
LS01963	13"+	Double	1	\$37.95	\$34.15
LS02054	13"+	Triple	1	\$39.95	\$35.95

Preserved Mink & Dissection Guide Set

10 double-injected, 13"-17" preserved mink (LS01963) and 5 copies of Mink Dissection guide (S08849). Specimens are skinned with scent glands and external abdominal fat removed. **LS01963(B) – \$385.00**

Mink Dissection Guide. A complete dissection guide for classes in general and vertebrate biology. 60 pages. **S08849 – \$15.95**



LS01431

Cats (with skin)

Product No.	Size	Injection	Qty.	Each	10+
LS03533	19"-23"	Plain	1	\$88.00	\$79.19
LS02505	19"-23"	Single	1	\$92.00	\$82.79
LS02907	19"-23"	Double	1	\$100.00	\$89.99
LS02506	19"-23"	Triple	1	\$108.00	\$97.19
LS02671	16"-23"	Double, Preg.	1	\$120.00	\$108.00
LS02672	16"-23"	Triple, Preg.	1	\$140.00	\$126.00
LS01429	14"-19"	Plain	1	\$83.00	\$74.69
LS01431	14"-19"	Double	1	\$87.00	\$78.29
LS03363	12"-14"	Double	1	\$99.00	\$89.09

Cats (skinned)

Product No.	Size	Injection	Qty.	Each	10+
LS03534	19"-23"	Plain	1	\$100.00	\$89.99
LS03535	19"-23"	Double	1	\$115.00	\$103.49
LS03536	19"-23"	Triple	1	\$125.00	\$112.49
LS03597	16"-23"	Double, Preg.	1	\$130.00	\$117.00
LS03598	16"-23"	Triple, Preg.	1	\$145.00	\$130.50
LS03556	14"-19"	Plain	1	\$100.00	\$89.99
LS03557	14"-19"	Double	1	\$110.00	\$98.99

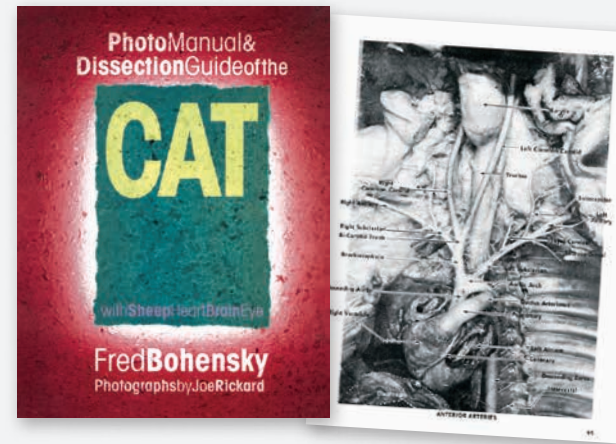

Dissection Guide to the Cat

Photos and illustrations guide student through the study of anatomical structures. Accompanying text offers dissection instructions and factual information about the section under observation. Tests at the end of each chapter. 167 pages. **SB42224 – \$20.95**

Nasco Cat Anatomy and Mammalian Organ Study Set with Photographic Atlas

Specimens of a preserved cat (double injected), sheep heart, sheep brain, cow spinal cord, cow eye, and pig kidney come with storage bags and *A Photographic Atlas of Cat Anatomy: With Sheep Heart, Brain, Eye, Kidney Dissection*. Shows actual specimens at different stages of dissection. Photos are arranged and listed by body system. **LS03710 – \$163.00**



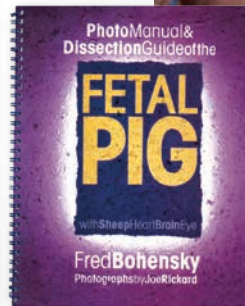
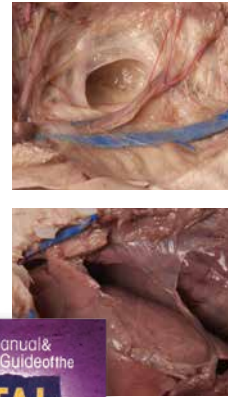

Fetal Pigs

Product No.	Size	Injection	Each	10+
LS03792	13"-16"	Double	\$36.00	\$32.39
LS03791	13"-16"	Single	\$33.75	\$30.37
LS03790	13"-16"	Plain	\$32.00	\$28.79
LS03789	10"-13"	Double	\$33.75	\$30.37
LS03788	10"-13"	Single	\$32.50	\$29.24
LS03787	10"-13"	Plain	\$30.95	\$27.85
LS03786	7"-10"	Double	\$27.95	\$25.15
LS03785	7"-10"	Single	\$26.95	\$24.25
LS03784	7"-10"	Plain	\$24.95	\$22.45
LS03783	4"-7"	Plain	\$20.95	\$18.85

Dissection Guide to the Fetal Pig

Photos and illustrations guide student through the study of anatomical structures. Accompanying text offers dissection instructions and factual information about the section under observation. Tests at the end of each chapter. 128 pages.
SB42225 – \$20.95



Fetal Pig Sagittal Section

Sagittal section of an 11"-12" artery-injected fetal pig for observing internal organs and vessels before starting dissection. Great demonstration tool in clear plastic bag to use as a demonstration model. Can be removed for dissection. Teacher's guide included.
LS03565 – \$29.95 10+ \$26.95

Pig Dissection Mat

Allows the student to follow the directions for a complete dissection without the worry of damaging books or paper. A complete pig dissection is printed directly on this 9¾" x 16" polyvinyl mat. It is resistant to spills and is easily cleaned with a sponge or paper towel.
SB32578 – \$11.25

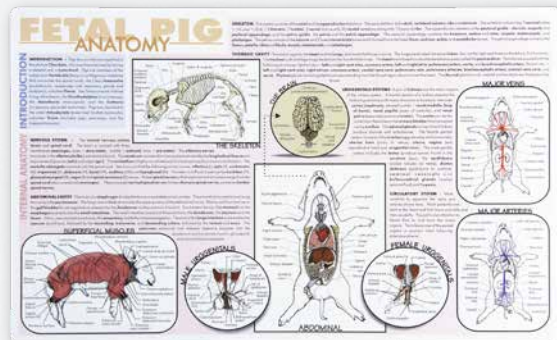

Fetal Pig Anatomy Aprons

Lightweight and disposable. Made of 3 mil polyethylene. Aprons do not protect from harsh chemicals. Box of 100.
SB35157 – \$93.95

A. Pig Organs

An excellent way to closely study organs that are remarkably similar to a human's.

Product No.	Description	Each	10+
LS02530	Heart	\$11.00	\$9.89
LS03808	Heart, double injected, arteries (red), veins (blue)	\$15.95	\$14.35
LS03569	Heart in pericardium	\$17.95	\$16.15
LS02532	Eye	\$1.95	\$1.75
LS03352	Kidney, plain	\$7.00	\$6.29
LS03353	Kidney, double injected	\$11.75	\$10.57
LS03489	Kidney, triple injected	\$13.25	\$11.92
LS03490	Ovary	\$3.95	\$3.55
LS03491	Uterus, nonpregnant, plain	\$26.25	\$23.62
LS03544	Stomach	\$23.50	\$21.15
LS03593	Small intestine, 1 ft. section	\$5.95	\$5.35
LS03612	Larynx w/epiglottis, vocal cords, and portion of trachea intact	\$8.50	\$7.64
LS01955	Nasco dry-preserved pig heart	\$42.00	–

B. Pig Organ Set

Get up close and personal with organs that are very similar to those of a human with this popular combination of preserved pig organs in a convenient storage box. Includes reclosable storage bag. Consists one each of four-chamber heart measuring 4"-5" (LS02530), eye (LS02532), kidney (plain, LS03352), and ovary (LS03490). Dissection guides for each organ are included.
LS03496 – \$22.95 10+ \$21.42

C. Nasco Dried Swine Lungs

Swine lungs are preserved, inflated to full size, and dried to produce a real odorless specimen. Lungs, once dried, are the consistency of Styrofoam. Order lung cross section (LS03686) to observe alveoli and other structures under binocular microscope. Teacher guide included.
LS01956 – \$82.95
Nasco Dried Lung Section. Perfect for observing the internal structures of the lung without having to slice a whole lung.
LS03686 – \$8.50



Large dissection trays on p. 83

NASCOGuard® keeps your materials preserved indefinitely – learn more on p. 64

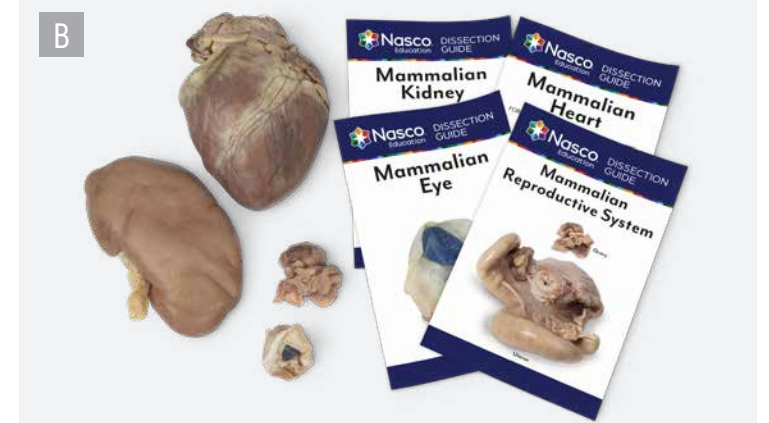
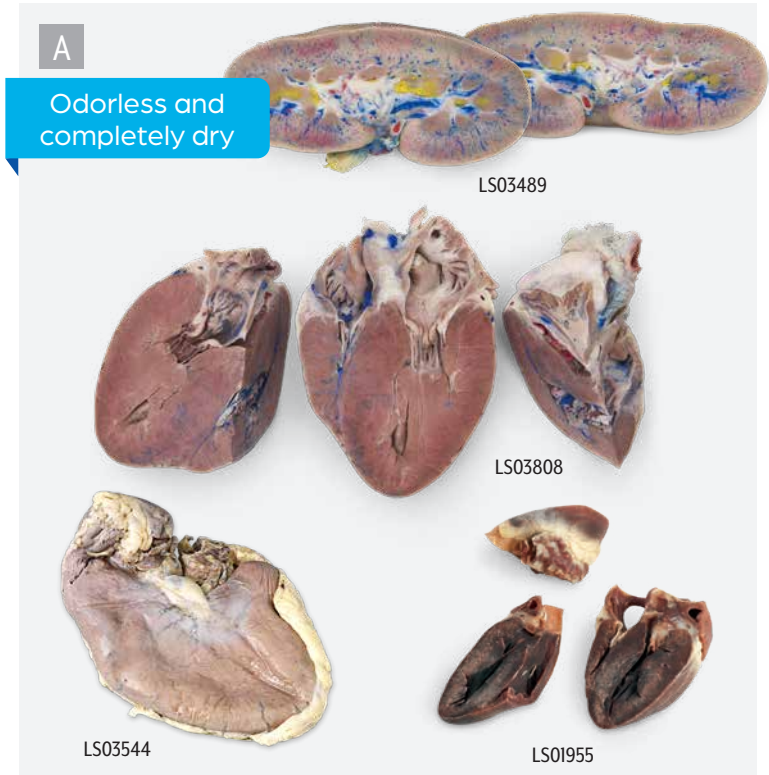

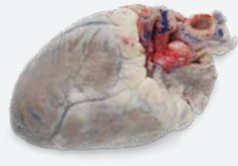

LS03701



LS03546



LS03493

Sheep Organs

Product No.	Description	Qty.	Each	10+
LS03699	Head with eyes, brain and lower jaw	1	\$16.55	\$14.89
LS01155	Heart	1	\$9.50	\$8.54
LS03701	Heart, double injected, arteries (red), veins (blue)	1	\$14.50	\$13.05
LS01152	Brain with cranial nerve roots	1	\$17.50	\$15.74
LS03354	Half Brain with cranial nerve roots	1	\$10.00	\$8.99
LS03570	Brain with hypophysis and cranial nerve roots	1	\$17.95	\$16.15
LS03546	Brain with dura mater	1	\$22.00	\$19.79
LS01439	Eyes	10	\$14.55	\$13.09
LS01440	Kidney	1	\$7.00	\$6.29
LS03493	Larynx with epiglottis, vocal cords, and portion of trachea intact	1	\$6.75	\$6.07
LS01627	Pluck. Heart, Lungs, and Trachea	1	\$22.25	\$20.02
LS03494	Testicle	1	\$11.25	\$10.12

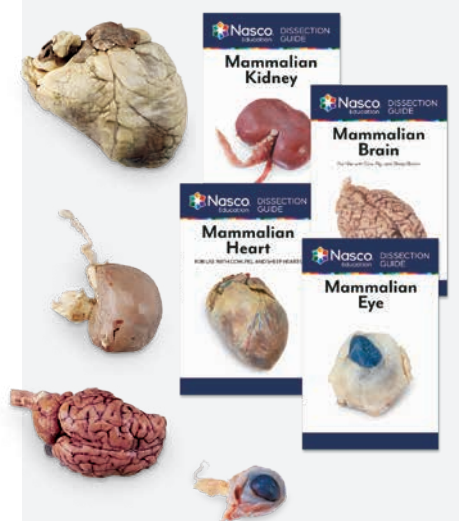

Sheep Organ Set

Eye, brain, kidney, and heart in storage box. Includes reclosable storage bag and dissection guides. **LS03140 – \$38.50**



Preserved Reproductive Tract From Cow

Complete female reproductive tract. Preserved with Nasco's exclusive Bio-Flex process. Can be kept in a plastic bag and used repeatedly for long periods of time. **LS02798 – \$103.50**

Set of 30



Mammalian Eye Comparison

Observe, compare, dissect, and determine the subtle difference between sheep, cow, and pig eyes. Includes 30 eyes of each type and 30 mammalian eye dissection guides. **LS03828 – \$104.95**



Mammalian Anatomy Survey Set

Sheep heart with aorta, sheep brain (half), cow spinal cord, cow eye, pig kidney, and dissection guide for each. **LS03497 – \$36.95 10+ \$33.99**

Cow Organs

Product No.	Description	Qty.	Each	10+
LS01630	Calf heart with base of aorta attached	1	\$33.50	\$30.14
LS01631	Calf light. Heart, lungs, and trachea. Lungs embalmed	1	\$58.95	\$53.05
LS01628	Eye	1	\$3.55	\$3.19
LS02533	Spinal cord, over 4" section	1	\$7.35	\$6.61
LS03488	Uterus, nonpregnant	1	\$31.75	–
LS03532	Calf testicles	1	\$12.00	–
LS03566	Elbow joint	1	\$68.95	–
LS03567	Longitudinal section of long bone	1	\$9.95	–
LS03568	Cross section of long bone	1	\$18.95	–



LS01630



LS03567



Cow Organ Set with Sheep Brain

A popular combination of cow organs in a convenient storage box. Includes reclosable storage bag. Consists of one cow eye, heart, spinal cord, and sheep brain. Dissection guides for each organ are included. **LS03495(SB) – \$45.95**

Zoology Survey Sets

Preserved specimens are individually packaged and shipped moist in vapor barrier plastic bags. Vacu-Pac process eliminates over 50% of shipping weight incurred with using fluid in breakable jars, as well as offering extended shelf life of several years. Small specimens are in a glass vial within the Vacu-Pac plastic. Reclosable storage bag included with each set.

Small

- 4"–6" worm (with clitellum)
- 4"–7" fetal pig
- 3" frog

LS03817 – \$17.50

3 specimens

Large

- 8"–10" earthworm
- 3/2"–5" crayfish
- 4"–5" clam
- 5"–6" sea star
- 7"+ perch
- 3" grass frog

LS03558 – \$13.25 10+ \$12.15

6 specimens

Medium

- 6"–8" earthworm
- 3"–4" crayfish
- 3"–4" clam
- 3"–5" sea star
- 5"–7" perch
- 3" grass frog

LS03498 – \$11.50 10+ \$10.22

Large

- 8"–10" earthworm
- Lubber grasshopper
- 3/2"–5" crayfish
- 4"–5" clam
- 5"–6" sea star
- 3"–4" clam
- 3"–5" sea star
- 7"+ perch
- 3" grass frog

LS03559 – \$17.50 10+ \$16.13

Medium

- 6"–8" earthworm
- Lubber grasshopper
- 3"–4" clam
- 3"–5" sea star
- 5"–7" perch
- 3" grass frog

LS01570 – \$15.95

7 specimens

Large

- 1/2"–3/4" Grantia (Scypha)
- 8"–10" earthworm
- Lubber grasshopper
- 3/2"–5" crayfish
- 4"–5" clam
- 5"–6" sea star
- 7"+ perch
- 3" grass frog

LS03560 – \$18.00 10+ \$16.84

8 specimens

Medium

- 1/4"–1/2" Grantia (Scypha)
- 6"–8" earthworm
- Lubber grasshopper
- 3"–4" crayfish
- 3"–4" clam
- 3"–5" sea star
- 5"–7" perch
- 3" grass frog

LS03499 – \$16.25 10+ \$14.95

Set 1, Large

- 1/2"–3/4" Grantia (Scypha)
- 8"–10" earthworm
- Lubber grasshopper
- 3/2"–5" crayfish
- 4"–5" clam
- 5"–6" sea star
- 7"+ perch
- 3" grass frog
- 7"–10" fetal pig

LS03578 – \$45.00 10+ \$42.29

9 specimens

Set 1, Medium

- 1/4"–1/2" Grantia (Scypha)
- 6"–8" earthworm
- Lubber grasshopper
- 3"–4" crayfish
- 3"–4" clam
- 3"–5" sea star
- 5"–7" perch
- 3" grass frog
- 4"–7" fetal pig

LS03563 – \$30.00 10+ \$27.32

Set 2, Large

Same as LS03578 above, except fetal pig is replaced with a 9" rat.

LS03705 – \$40.00 10+ \$35.72

Bulk Assortments

Buy in bulk and save on packing, container, and labor costs. Shipped in easy-to-store cartons with small specimens in separate jars.

7 Specimen – Large (10 of each)

- 8"–10" earthworm
- 3/2"–5" crayfish
- 4"–5" clam
- 5"–6" sea star
- 7"+ perch
- 3" grass frog
- Lubber grasshopper

LS03604 Set of 70 specimens – \$125.00 5+ \$114.12

7 Specimen – Medium (10 of each)

- 6"–8" earthworm
- 3"–4" crayfish
- 3"–4" clam
- 3"–5" sea star
- 5"–7" perch
- 3" grass frog
- Lubber grasshopper

LS03603 Set of 70 specimens – \$110.00 5+ \$96.11



Grantia (Scypha)



Earthworm

Lubber grasshopper



Crayfish



Clam

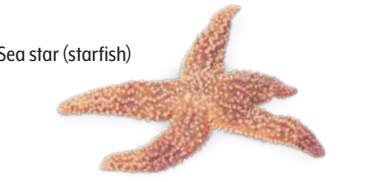

Sea star (starfish)



Perch



Grass frog

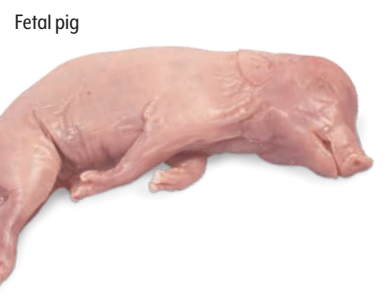

Fetal pig



Animal Kingdom Survey Set

Collection of 12 display mounts (6" x 5" each) with a total of 49 fully labeled specimens across 7 phyla. Contains:

- *Spongilla*
- *Scypha*
- *Chalina*
- Commercial sponge
- Anemone
- Jellyfish
- Hard coral
- Soft coral
- Pectin
- Snail
- *Chiton*
- Squid
- Leech
- Scale worm
- Earthworm
- Starfish
- Brittle star
- Sand dollar
- Sea cucumber
- Sea urchin
- Centipede
- Millipede
- Tick
- Spider
- Scorpion
- Horseshoe crab
- Grasshopper
- Cicada
- Beetle
- Butterfly
- Stink bug
- Wasp
- Louse
- Caddisfly larva
- Termite
- Pill bug
- Barnacle
- Shrimp
- Crab
- Seahorse
- Tadpole
- Turtle
- Exoskeleton
- Shell
- Scale
- Feather
- Quill
- Hair

On occasion, similar specimens may be substituted due to availability.
SB37287 – \$375.00



Insect Specimen Blocks – Insect Orders

10 preserved specimens in clear resin blocks with scientific name tags. Represents 10 different insect orders. Chafer beetle, cicada, monarch butterfly, dragonfly, onion fly, cricket, honey bee, cockroach, shield bug, and praying mantis. **CHOKING HAZARD (I).** Not for under 3 yrs.
SB48191 – \$140.00



Resin Casting Specimen Mount Kit

4-oz. mold release, rectangle mold, dome mold, and 32 oz. of clear casting resin.
◆ 9726894 – \$59.95



Animal Kingdom Mount Set

Each specimen embedded in clear acrylic block. Collection of 20 specimens includes:

- Leech
- Cuttlefish
- Spider
- Centipede
- Crab
- Swordtail fish
- Frog
- Turtle
- Zosterops
- Mouse
- Long horned beetle
- Cricket
- Cockroach
- Wasp
- Lychee stink bug
- Cicada
- Mantis
- Butterfly
- Dragonfly
- Stick insect
- Latched carry case

SB47476 – \$380.00



Animal Kingdom Mount Set

Each specimen embedded in clear acrylic block. Collection of 12 specimens includes:

- Paramecium
- Sea anemone
- Tapeworm
- Roundworm
- Leech
- Cuttlefish
- Scorpion
- Tiger barb fish
- Frog
- Tortoise
- Zosterops
- White mouse
- Carry case with magnetic closure

SB47475 – \$250.00



A. United Scientific Dissection Kit

Set of 8 tools includes dissecting scissors, dissecting forceps, scalpel with replacement blade, straight teasing needle, 2 curved teasing needles, dropping pipet, vinyl ruler, and 6 T-pins. Includes a hard case for storage.
NE30313 – \$17.50

B. Nasco Basic Dissecting Kit

Single fold vinyl case with lining, 1½" chrome single blade scalpel, 4½" chrome wire dissecting scissors, 4½" chrome-plated forceps, pipette, straight dissecting needle, bent dissecting needle, and 6" ruler.
SB12623 – \$12.00

C. Basic Elementary Dissecting Kit

Single-fold vinyl case with lining, 6" chrome replacement blade scalpel, 4½" stainless steel dissecting scissors, 4½" chrome-plated forceps, straight dissecting needle, bent dissecting needle, pipette, and 6" ruler.
SA01127 – \$10.25

D. Basic Elementary Dissecting Kit

Same as the kit above (SA01127) but in semi-transparent hinged case with snap cover and insert for the 7 instruments.
SB07839 – \$11.95

E. Biology Dissecting Kit with Case

12 instruments: No. 4 stainless steel scalpel handle, 1½" stainless steel narrow blade scalpel, 5½" stainless steel sharp/sharp scissors, 4½" stainless steel straight iris scissors, 5½" stainless steel thumb forceps, 4½" chrome curved medium-point forceps, 6" chrome probe and seeker, 6" ruler, a straight and bent dissecting needle, pipette, and 6 No. 22 scalpel blades.
SB10272 – \$22.95

▲ See page 3 for complete Choking Hazard Label Information.

◆ DOT hazardous material ◆ Subject to DOT hazardous material surcharge.



F. Biology Dissecting Kit

Double fold vinyl case with lining; 1½" stainless steel scalpel; 1½" stainless steel narrow blade scalpel; 5½" stainless steel sharp/blunt scissors; 4½" stainless steel iris scissors; 4½" chrome, straight, fine-point forceps; 4½" chrome, curved, fine-point forceps; 5" chrome, straight, blunt-point forceps; straight dissecting needle; bent dissecting needle; 6" chrome probe and seeker; and 6" ruler.
SA04449 – \$21.00

G. Advanced Dissecting Kit

Zipper case with velvet-like lining and stainless steel instruments: No. 3 surgical handle with No. 10 replaceable blade (2 extra blades included), 1½" narrow blade scalpel, 5½" sharp/blunt operating scissors, 4½" straight iris scissors, 5½" thumb forceps, 4½" fine-point forceps, mall-probe and seeker, and straight teasing needle.
SB12625 – \$23.00

H. University Level Anatomy Dissecting Kit

Black vinyl, zippered case has red velvet inner lining with 10 loops for organization. Contains straight teasing needle, bent teasing needle, 4½" iris scissors, 4½" medium point forceps, cartilage knife, 1 x 2 teeth tissue forceps, 5½" surgical scissors, #3 scalpel handle, mall probe, #10 scalpel blades (pkg. of 10), 5" hemostatic forceps, and 6" ruler. **CHOKING HAZARD (I).** Not for under 3 yrs.
SB46659 – \$37.95



I. Large Animal Dissecting Kit

Canvas roll case with 2 pockets and adjustable loops to hold additional instruments; 6¼" stainless steel Pean hemostat; 5½" stainless steel Kelly hemostat; No. 3 stainless steel scalpel handle; No. 10 scalpel blades (6); No. 11 scalpel blades (6); 4½" stainless steel iris scissors; 5½" stainless steel operating scissors; 4½" chrome, straight, fine-point forceps; 5½" chrome, straight, medium-point forceps; 6" chrome probe and seeker 5¼" section lifter; metal, straight dissecting needles (2); 2½" double-prong flesh hooks; and 6" celluloid ruler.
SA01129 – \$37.95



Molded Plastic Dissecting Case

Semi-hard plastic case. Easy to clean. Slots for individual tools. Autoclavable. Colors may vary.
SB15400 – \$6.00

Classroom Dissection Instrument Sets

A set of quality dissection instruments for the entire classroom. Instruments come in instrument sorting tray. For 30 students working in pairs. **⚠ CHOKING HAZARD (I).** Not for under 3 yrs.

Stainless Steel Grade Set A Includes:

- (15) 4½" stainless steel dissecting scissors (SA01146)
- (15) No. 4 stainless steel surgeon's handles (SB07833)
- (20) No. 22 scalpel blades (SB09348)
- (15) 4½" fine-point, stainless steel forceps (SBI2629)
- (15) straight steel teasing needles
- (15) angular chrome probe and seekers (SB07838)
- (1) box of 2" dissecting pins (SA01463)
- (1) instrument sorting tray (SB25286)

SB15428 — \$177.00

Chrome Grade Set B Includes:

- (15) 4½" chrome dissecting scissors (SA01145)
- (15) chrome safety-lok scalpels. Includes No. 22, scalpel blades (SA01177)
- (15) 4½" fine-point, chrome forceps (SA01134)
- (15) straight wood handle teasing needles (SBI5414)
- (15) bent plastic handle teasing needles
- (1) box of 2" dissecting pins (SA01463)
- (1) instrument sorting tray (SB25286)

SB15429 — \$142.00



Instrument Sorting Tray
5 compartments, 20½" x 11¼" x 2".
SB25286 — \$13.75



A *Stainless steel*



B *Stainless steel*



No. 10 No. 21 No. 22



E *Stainless steel*



F *Stainless steel*



C *Stainless steel*

SA01146

Chrome

SA01145



G *Stainless steel*

A. Surgeon's Handle No. 3
No. 3 stainless steel surgeon's handle for Nos. 10, 11, 12, and 15 surgeon's blades.
SB06903 — \$5.55 12+ \$ 4.99

B. Surgeon's Handle No. 4
No. 4 stainless steel handle for Nos. 20, 21, 22, 23, and 24 surgeon's blades.
SB07833 — \$5.55 12+ \$4.99

C. Dissecting Scissors, Straight, Fine Point
SA01146 4½" Stainless Steel — **\$3.05 12+ \$2.74**
SA01145 4½" Chrome — **\$2.15 12+ \$1.93**

D. Surgical Scalpel Blades
Pack of 10. **⚠ CHOKING HAZARD (I).** Not for under 3 yrs.
SB09342 No. 10 SB09348 No. 22
Pack — \$2.35

Box of 100. **⚠ CHOKING HAZARD (I).** Not for under 3 yrs.
SB09351 No. 10 SB09357 No. 22
SB09356 No. 21
Box — \$19.00

E. Iris Research Scissor
Straight-blade scissor with sharp points. 4½"L.
SB06901 — \$3.05 12+ \$2.74

F. 1 Point Sharp/1 Point Blunt Surgical Scissors
SB15420 4½" — **\$3.05 12+ \$2.74**
SB10283 5½" — **\$3.35 12+ \$3.01**
SB15408 6½" — **\$3.55 12+ \$3.19**

G. Both Points Sharp Surgical Scissors
SB15417 4½" — **\$3.05 12+ \$2.74**
SB10282 5½" — **\$3.25 12+ \$2.92**
SB15406 6½" — **\$3.55 12+ \$3.19**



H *Sterile — pack of 10*



K *Chrome-plated steel*



SB18875

SB48152



SB12628

SB12629

Stainless steel

H. Sterile Disposable Scalpels
Plastic handle shaped for comfortable grip and easy manipulation of high-quality surgical steel blade. Honed to provide extremely sharp cutting edges. Packs of 10.
SB15239 No. 10 Blade for Fine Dissection — **\$24.95**
SB15240 No. 11 Blade for Microdissection — **\$24.95**
SB15241 No. 21 Blade for Gross Dissection — **\$24.95**

I. Scalpel — Student Grade
One-piece chrome scalpel, 1½" blade.
SB12627 — \$2.05 12+ \$1.84

J. Scalpel
One-piece scalpel, 1½" blade, satin finish handle. Superior grade.
SA01179 — \$1.75 12+ \$1.57

K. Safety-Lok Scalpel — Student Grade
Chrome-plated forged steel with screw lock to hold No. 22 blade firmly in place.
SA01177 — \$2.05 12+ \$1.84

NOTE: For replacement blades, order No. 22 (SB09348) blade listed on p. 80.



I *Chrome*



L



O

Pack of 12



Q

Chrome plated



T

SB15410

SB15425

Stainless steel

L. Snap-Off Blade Knife
Retractable blade snaps off easily when fresh point is desired. Plastic knife includes 1 blade with 13 points.
9705448 — \$1.40 10+ \$1.24

M. Plastic Handle Teasing Needle
Straight. Pack of 12.
S08847 — \$3.95 12+ \$3.55

N. Plastic Forceps
4"L (11 cm).
SB18875 Fine Point — **\$1.35 12+ \$1.21**
SB48152 Blunt Tip — **\$1.65 12+ \$1.48**

O. Wood Handle Teasing Needle
Straight. Pack of 12.
SB15414 — \$3.55 12+ \$3.19

P. Probe and Seeker
Mall probe 6"L. Solid steel, chrome-plated. Angular, semi-blunt tip. 6 mm dia. Hexagonal handle.
SB07838 — \$1.55 12+ \$1.39

Q. Forceps
Serrated inside tips. Chrome plated. Fine. 4½"
SA01133 — \$2.10 12+ \$1.88



J

Stainless steel



M

Stainless steel



R

Stainless steel



S

Stainless steel



U

Stainless steel



V

Stainless steel

R. Tissue Forceps
Stainless steel forceps with 1" x 2" teeth. Superior grade. 5½".
SB15411 — \$3.25 12+ \$2.92

Dissecting Forceps
With serrated points and guide pin. 4½".

Product No.	Type	Material	Each	12+
SB12628	Straight	Stainless Steel	\$3.25	\$2.92
SB12629	Curved	Stainless Steel	\$3.05	\$2.74

Product No.	Type	Material	Each	12+
SB15410	Straight	Stainless Steel	\$3.05	\$2.74
SB15425	Curved	Stainless Steel	\$3.05	\$2.74

U. Thumb Forceps
Stainless steel. 5½"L.
SA04467 — \$3.25 12+ \$2.92

V. Microdissection Forceps
4½". Stainless steel. Extra-long.
SB12630 — \$3.05 12+ \$2.74



A. Blue Nitrile Gloves
100% synthetic nitrile polymer gloves are latex, powder, and odor free. 5 mil thick. Box of 100 for small, medium, and large; box of 90 for X-large. 5 mil thickness.
C20030 Small **C20031** Medium **C20032** Large **C20033** X-Large
Each — \$19.95



B. Gold Latex Powder-Free Gloves
Made with light chlorination rinse. Nonslip, tacky surface provides excellent grip for both dry and wet applications. Minimum risk of potential glove-related chemical or protein allergies. Box of 100 for medium and large; box of 90 for X-large. 4 mil thickness.
C31908 Medium **C31909** Large **C31910** X-Large
Each — \$16.95



C. Low Density Polyethylene Powder Free Gloves
Dispenser box of 100 gloves. 1½ mil thickness.
SB48963 Small **2100320** Medium
2100321 Large
Box — \$4.95



Nasco 18" x 11" Dissection Tray Complete Set
For large pigs. Dissection tray, pad, and cover.
SB46037 — \$49.95



Specimen Storage Bags
Packs of 25.

Product No.	Size	Pack
SB48481	10" x 18"	\$5.25
SB48482	12" x 30"	\$8.50



Reusable

Black Wax Dissecting Pans

One-piece aluminium construction will not rust, crack, or leak.

Product No.	Description	Each	10+
SA00328	Standard (11½" x 7½") w/wax	\$21.95	\$19.75
SB07238	Standard pan only	\$12.95	\$11.65
SB07156	Deluxe (13½" x 9¾" x 2¼") w/wax	\$24.95	\$22.45



Disposable Dissection Trays
Set of 30; 9¼" x 11¼".
SB41945 — \$8.95

Shark Tray

Molded of heavy-gauge, high-density polyethylene. Unbreakable, lightweight tray is chemical-resistant with nonskid bottom. Accepts dorsal muscle, with center groove for dorsal spines. 15½" x 31" x 1½". Clear, plastic cover fits firmly over tray.
SB13624 — \$32.95 10+ \$29.65



Economy Safety Glasses

Wide, single-piece lens and adjustable temples. Made of durable polycarbonate. Meets ANSI Z87.1 high impact standards.

SB32854 Blue Frame
SB39510 Black Frame
Each — \$3.95

NEW

United Scientific® Dissection Pins with Label Holder

Steel pins coated with a corrosion-resistant finish include a coiled loop that opens with a squeeze to hold labels. Pack of 50 pins.
NE30520 — \$16.50



Dissecting Pins
Steel pins with smooth sharp points. ½-lb. box. 2"L.
SA01463 — \$11.75



T-Pins

Steel nickel-plated, ½-lb. box. Approximately 375 pins. 2"L.
2500120 — \$27.00

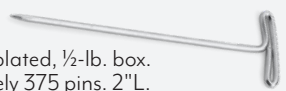

Don't see it here?
Find it at
nascoeducation.com

Nasco Dissection Pans

High-density polyethylene pans:

- Less expensive than aluminum
- Will not rust, crack, or leak
- Bottom retains shape — does not become rounded with use
- Not as deep — easy to perform routine dissections
- Designed to be used with Flex-Pads only, not with wax
- Chemical resistant
- Stackable for storage

Small Basic Dissecting Pan

Designed for grades with routine dissections using earthworms, crayfish, clams, grasshoppers, sea stars, perch, and grass frogs. Outside dimensions: 10" x 7".

Medium Standard Dissecting Pan

For general student use in dissection. Available in both tough, high-density polyethylene and durable, one-piece aluminum construction. Neither will rust, crack, or leak. Outside dimensions: 11½" x 7½".

Nasco Large Animal Dissection Tray

Designed for cats, rabbits, mink, and other large animals. Unbreakable, lightweight tray is chemical-resistant and has a skid-resistant bottom. Stack trays for storage. Clear plastic cover fits firmly over tray to prevent moisture loss and nestles for storage, but is not designed to stack with specimens inside.

Product No.	Description	Each	10+
SB32649	Tray, Flex-Pad and cover	\$91.95	\$82.75
SB07288	Dissection tray and pad	\$79.95	\$71.95
SB09565	Tray only (30" x 16")	\$49.95	\$44.95
SB07840	Flex-Pad only (22¼" x 8¾")	\$34.95	\$31.45
SB09913	Cover only	\$22.95	\$20.65



- Flex-Pad advantages:
- Washable
 - Latex free
 - Smooth surface
 - Clean
 - Removable
 - Odorless
 - Long lasting
 - Pins do not require cleaning after use

Nasco Flex-Pad replaces messy dissection wax

Cut to the size you need

Nasco Flex-Pad Bulk Sheets

Trim with scissors or utility knife to fit irregular-size dissection pans. Basic, Standard, or Deluxe Flex-Pads will fit the vast majority of pans in use. Each bulk sheet fills about 4 dissection pans. Bulk sheet size: 24½" x 17".
SB09801 — \$57.95
10+ \$52.15



MICROSCOPES

Your students will be amazed at the microscopic world around them. Find stereo, compound, and digital microscopes as well as advanced functionality through your computer, smartphone, or whiteboard. Discover time-lapse photography, projection, and video capabilities.

The right microscopes, slides, and accessories are right here.



Nasco Elementary Stereo Microscope
Offers economy along with precise engineering. Unit has many features of advanced modular instruments.

Specifications:

- Paired, 10X eyepieces with 20X magnification
- Interpupillary adjustment
- Left diopter adjustment on illuminated models
- Paired 2X objectives
- Large 4½" x 7⅝" stage with a frosted glass insert
- Locked-together rack-and-pinion focusing
- Stops prevent head removal
- Adjustable 360° rotating head
- Reversible black/white plate and frosted glass stage plate
- Ebony finish, chemical resistant
- Three-wire cord
- Dust cover

SB25261 – \$185.00

- Elementary Microscopes **84–86**
- Middle School Microscopes **87–88**
- High School Microscopes **89–92**
- Digital Microscopes **93–96**
- Magnifiers **97**
- Slides **98–101**

BEST SELLER

National Elementary Standard Microscope

- Revolving wide-field 10X eyepiece, 45° inclined head with pointer, rotates 360°
 - Achromatic, color-coded 4X, 10X, 40XR
 - 40X, 100X, and 400X magnification
 - LED illumination
 - Slip clutch
 - Rack stops
 - Locked-on, spring-activated stage clips
 - Cast metal frame
 - Oversized focusing knobs range between normal coarse to fine focus
 - Three-wire cord and plug
 - Vinyl dust cover
 - 11"H with 3½" x 3¼" stage
- SB52272 – \$179.95**

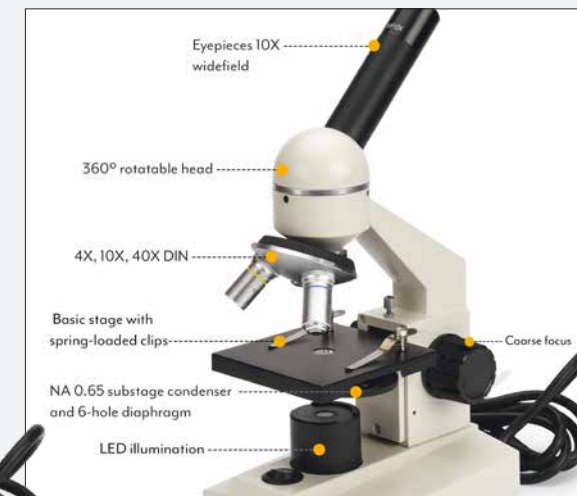

National Elementary Compact Microscope with Cordless LED Illumination – Model 205

Ideal for primary levels. Monocular microscope supports an 18 mm field of view. Also features low position focusing controls, state-of-the-art LED illumination, one-touch stage clips, and inward facing nosepiece for maximum operating space.

- Specifications:**
- Wide-field 10X monocular eyepiece with 45° inclined viewing head
 - 4X, 10X, and 40X objectives
 - 185 mm focal length
 - Separate coarse and fine focus
 - 70-milliwatt/3.5V LED illumination with intensity control
- SB49055 – \$260.00**



Nasco Elementary Mirror Microscope

- Specifications:**
- Cast metal with inclination joint
 - Rack-and-pinion focusing
 - Slip clutch
 - Magnification 25X
 - Plano-concave mirror in fork mount
 - 88 x 98 mm stage with stage clips
 - Locked on WF10X eyepiece with pointer
 - 6-hole disc diaphragm
 - Vertical head
 - Mirror for illumination
 - Dust cover
- SB28921 – \$92.00**



MicroPro™ Elementary Microscope Kit
Features glass eyepieces and power settings from 50X to 600X for superior precision viewing.

- Die-cast metal microscope
- 10X and 20X glass eyepieces
- 3 prepared slides
- 8 blank slides
- Lab supplies
- 18-page instruction and activity guide
- Requires 2 "AA" batteries, not included

⚠ CHOKING HAZARD (1). Not for under 3 yrs.
SB39462 – \$59.95

NEW

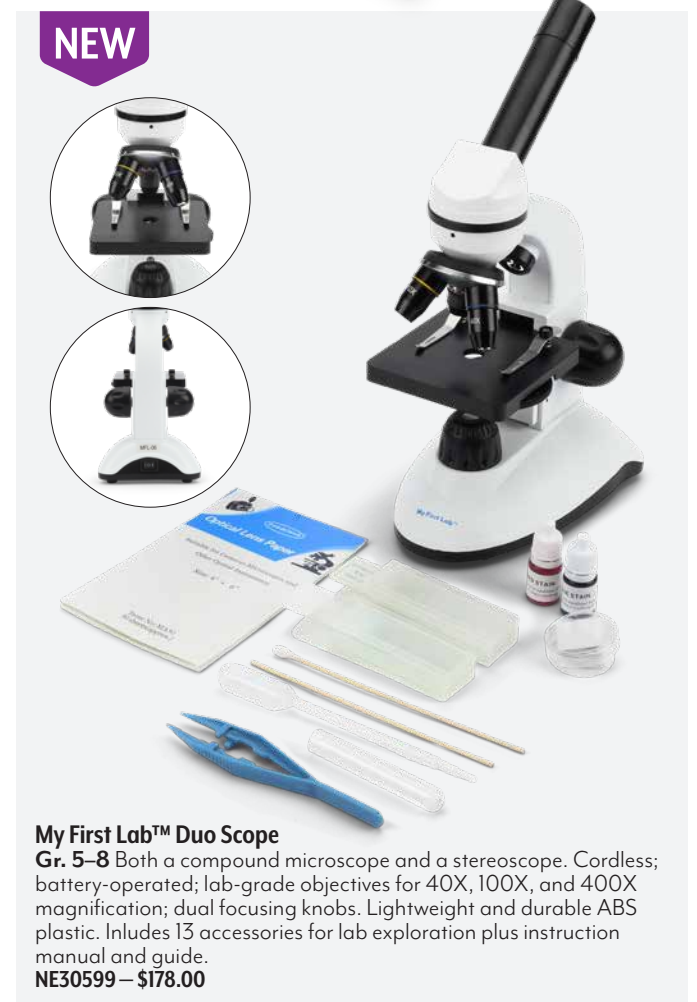

My First Lab™ Duo Scope
Gr. 5–8 Both a compound microscope and a stereoscope. Cordless; battery-operated; lab-grade objectives for 40X, 100X, and 400X magnification; dual focusing knobs. Lightweight and durable ABS plastic. Includes 13 accessories for lab exploration plus instruction manual and guide.
NE30599 – \$178.00

NEW

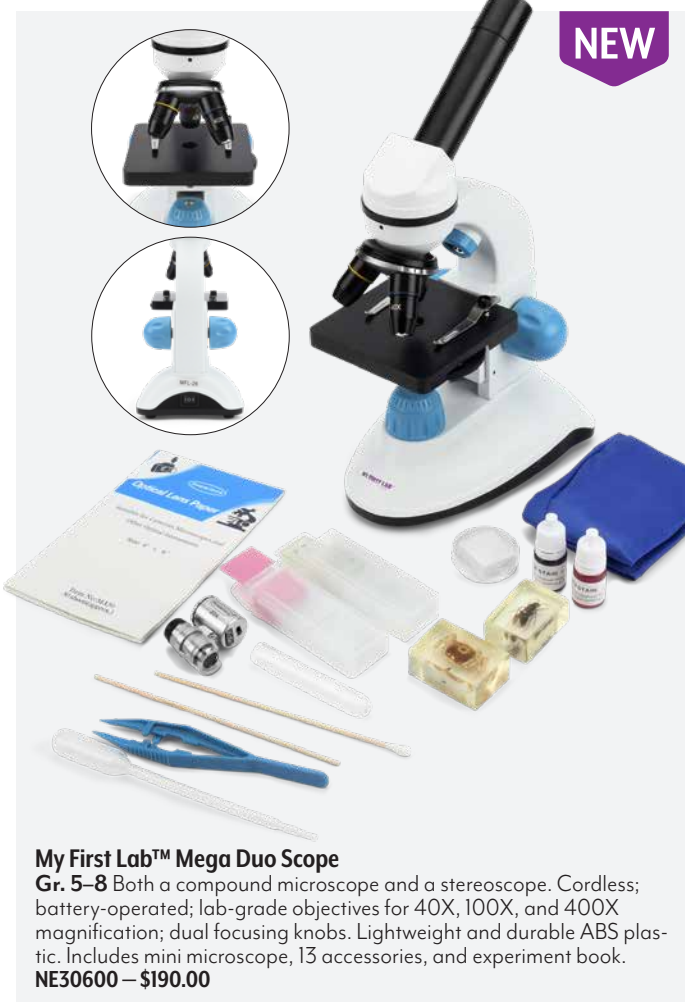

My First Lab™ Mega Duo Scope
Gr. 5–8 Both a compound microscope and a stereoscope. Cordless; battery-operated; lab-grade objectives for 40X, 100X, and 400X magnification; dual focusing knobs. Lightweight and durable ABS plastic. Includes mini microscope, 13 accessories, and experiment book.
NE30600 – \$190.00

BEST SELLER



Nasco Middle School Standard Microscopes

Specifications:

- Wide-field locked-on 10X eyepiece with pointer
- 360° rotatable head
- DIN objectives are parfocal, parcentered, achromatic, color-coded 4X, 10X, 40XR (retractable)
- Triple nosepiece with positive click stops
- Coarse and fine coaxial focusing with built-in slip clutch
- Fluorescent illumination
- Locked-on spring-loaded stage clips
- Three-wire cord
- Dust cover

Product No.	Head	Eyepiece	DIN Objectives	Stage	Illumination	Each
SB24173	Monocular	WF10X/pointer	4X, 10X, 40XR	0.65 NA condenser 5-hole disc diaphragm	20-watt LED	\$220.00
SB25252	Monocular	WF10X pointer	4X, 10X, 40XR	Add-on mechanical stage side adjustment	20-watt LED	\$255.00
SB37674	Monocular	WF10X/pointer	4X, 10X, 40XR	0.65 NA condenser 5-hole disc diaphragm	LED cordless	\$290.00

To download this free lesson plan, visit resources.nascoeducation.com and search U27706

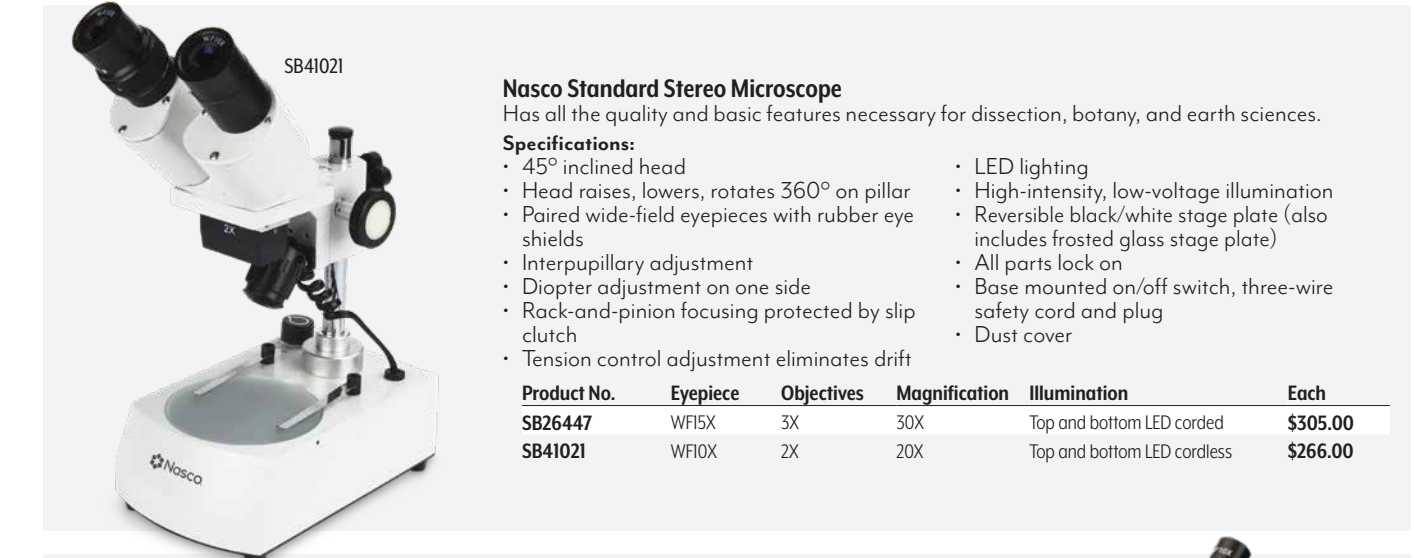

Nasco Standard Stereo Microscope
Has all the quality and basic features necessary for dissection, botany, and earth sciences.

Specifications:

- 45° inclined head
- Head raises, lowers, rotates 360° on pillar
- Paired wide-field eyepieces with rubber eye shields
- Interpupillary adjustment
- Diopter adjustment on one side
- Rack-and-pinion focusing protected by slip clutch
- Tension control adjustment eliminates drift
- LED lighting
- High-intensity, low-voltage illumination
- Reversible black/white stage plate (also includes frosted glass stage plate)
- All parts lock on
- Base mounted on/off switch, three-wire safety cord and plug
- Dust cover

Product No.	Eyepiece	Objectives	Magnification	Illumination	Each
SB26447	WF15X	3X	30X	Top and bottom LED corded	\$305.00
SB41021	WF10X	2X	20X	Top and bottom LED cordless	\$266.00

Nasco Middle School LED Standard Microscopes
Precision-built, tamper-proof microscopes incorporate high-resolution, flat field objectives with wide-angle viewing.

Specifications:

- 10X wide-field eyepiece, locked on with calibrated pointer
- Monocular 45° inclined head or 45° dual view head — both with 360° rotation
- Reverse nosepiece
- Objectives are DIN achromatic, parcentered, parfocal, and color coded 4X, 10X, 40XR
- Positive stops at both ends of travel
- Tension adjustment eliminates stage drift
- LED illumination
- Coaxial coarse and fine focusing
- Dust cover and instructions
- Spring-loaded stage clamp
- Large plain stage (4¾" x 4½") with spring clips, 0.65 N.A. condenser, and iris diaphragm
- Cordless microscopes are rechargeable

Product No.	DIN Objectives	Stage	Head	Illumination	Voltage	Each
SB37509	4X, 10X, 40XR	0.65 N.A. condenser with iris diaphragm	Monocular	LED corded	110V	\$291.00
SB41037	4X, 10X, 40XR	0.65 N.A. condenser with iris diaphragm	Monocular	LED cordless	110V	\$320.00
SB41036	4X, 10X, 40XR	0.65 N.A. condenser with iris diaphragm	45° Dual	LED corded	110V	\$307.00
SB41035	4X, 10X, 40XR	0.65 N.A. condenser with iris diaphragm	45° Dual	LED cordless	110V	\$342.00





Intermediate Student Microscope with LED Light

- Metal construction
- Rotatable head
- Fine focus control
- Objective lenses 4X, 10X, and 40X
- 100,000-hour, 4.5V LED cool illumination light
- Built-in 15-hour rechargeable battery
- Detachable AC power cord

SB45405 110V — \$155.00



Premiere® Middle School Standard Microscope

Features LED lighting and a mechanical stage for smooth observation.

Specifications:

- Wide-field 10X eyepiece with pointer
- Monocular, 45° inclined and rotatable 360°
- 4X, 10X, and 40X objectives
- Total magnification: 40X to 100X
- Brightfield, cool LED illumination and 6-hole disc diaphragm
- Coaxial coarse and fine focusing controls
- Mechanical stage
- Stage dimensions: 3 1/16" x 3 1/16"
- 110V power supply

SB52649 — \$180.00

BEST SELLER



Premiere® Cordless High School Standard Microscope

An upgraded cordless student microscope with a mechanical stage and powerful magnification of up to 1,000X.

Specifications:

- 10X eyepiece with pointer
- 4X, 10X, 40X, and 100X oil-immersion objectives
- Magnification power of 40X to 1,000X
- Rotatable head
- Coarse and fine focusing controls
- Mechanical stage with clips
- Coaxial diaphragm
- Built-in rechargeable battery with 15 hours of life and detachable AC power cord
- LED lighting system
- Long LED bulb life of 100,000 hours
- Dust cover and immersion oil included
- Metal construction

SB52648 — \$340.00

BEST SELLER

EXCLUDED FROM DISCOUNTS



Premiere® High School Binocular Microscope

- Dual LED illumination (both incident and sub-stage illumination)
- 4X, 10X, and 40X DIN objectives
- 10X WF eyepiece
- Separate coarse and fine illumination
- Mechanical stage
- 1.25 NA iris diaphragm

SB46630 — \$284.95

National Middle School Standard Microscope

Includes heavy vinyl dust cover.

Specifications:

- Wide-field 10X eyepiece with revolving pointer (dual head model includes eyepieces in both viewing tubes)
- 45° inclined viewing head rotates 360°
- Objectives 4X, 10X, and 40XR on ball-bearing mounted 3-hole nosepiece are parfocal, parcentered, low-reflection coated
- 110 mm x 120 mm stage with locked-on stage clips or optional graduated mechanical stage
- In-stage 0.65 condenser lens
- Low-position coarse and fine focusing knobs
- Safety rack stop prevents damage to lenses or slides
- LED illumination provides virtually no heat and 50,000 hours of bulb life

Product No.	Model	Head	Illumination	Each
SB42834	131-CLED	Monocular	LED cordless	\$310.00
SB44745	132-CLED	Dual	LED corded	\$401.00



SB42834

SB44745

Nasco High School Advanced Microscopes

Compact ergonomic microscopes with built-in handle, variable LED illumination, and high-performance objective lenses that provide excellent clarity. Equip long-term trinocular microscope with digital camera and LCD screen for photo and video image analysis.

Specifications:

- Metal frame with arm and base made of one-piece construction
- Siedentopf head (50/50 light splitting ratio), 30° inclined and 360° rotatable, interpupillary adjustment of 55–75 mm
- 10X wide-field eyepieces with diopter adjustment on right eyepiece tube and calibrated pointer on one eyepiece
- Revolving reversed quadruple objective nosepiece
- Objectives are DIN achromatic 4X, 10X, 40XR (retractable), 100XR (retractable) oil
- Low position coaxial coarse and fine focus knobs on both sides with positive focus stop and tension adjustment
- Focusing range of 14 mm, fine focus graduation of 0.01 mm
- Dust cover and instruction manual
- 1X C-mount included for trinocular head
- 125 mm x 125 mm built-in double-layer mechanical stage, smooth X-Y calibrated movement with cross travel range 60 x 40 mm
- Focusable sub-stage N.A. 1.25 Abbe condenser with iris diaphragm mounted on rack-and-pinion system
- 1-watt LED illumination with light intensity control

Product No.	Head	Each
Z48549	Binocular	\$455.00
Z48550	Trinocular	\$505.00

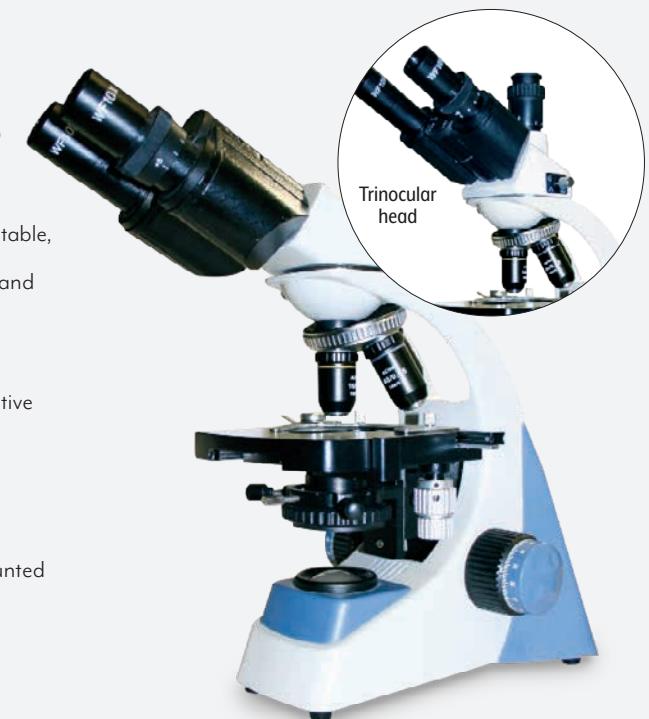

Trinocular head

**BEST
SELLER**



Nasco High School Standard Microscopes

Economical but with all of the quality features found on more expensive microscopes. Requires limited maintenance. Top-quality optics.

Specifications:

- All-metal body and mechanism
- Student-proof construction
- Separate coarse and fine adjustment
- Viewing head inclined
- Locked-on 10X wide-field eyepiece with calibrated pointer
- Stage drilled and tapped for add-on mechanical stage
- Stage stop and slip clutch
- LED illumination
- Drift adjustment
- Spring-loaded stage clips
- Monocular or dual viewing head rotates 360° DIN objective lenses are achromatic, parfocal, color-coded with 40XR and 100XR (oil) lens (retractable)
- Built-in 0.65 stage condenser, 5-aperture disc diaphragm for 3 objective models
- Substage illuminator with on/off switch
- Vinyl dust cover

Product No.	Viewing Head	DIN Objectives	Substage	Illumination	Each
SB25253	Monocular 10X wide-field with calibrated pointer	4X, 10X, 40XR	0.65 NA condenser 5-hole disc diaphragm	LED corded	\$331.00
SB48590	Monocular 10X wide-field with calibrated pointer	4X, 10X, 40XR	Includes mechanical stage side adjustment	LED corded	\$400.00
SB25255	Monocular 10X wide-field with calibrated pointer	4X, 10X, 40XR, 100XR oil	Abbe 1.25 focusable Abbe condenser with iris diaphragm	LED corded	\$385.00
SB48589	Monocular 10X wide-field with calibrated pointer	4X, 10X, 40XR, 100XR oil	Includes mechanical stage side adjustment	LED corded	\$470.00
SB29118	90° Video/Dual 10X wide-field with calibrated pointer	4X, 10X, 40XR	0.65 NA condenser 5-hole disc diaphragm	LED corded	\$327.00



Nasco High School Advanced Monocular Microscope

Specifications:

- Coarse and fine coaxial focusing
 - Locked-on 10X wide-field eyepiece, with pointer
 - 4X, 10X, 40XR, 100XR oil DIN objectives
 - 45° inclined monocular head, 360° rotation
 - Objectives are DIN achromatic, parcentered, parfocal color-coded with 4X, 10X, 40XR and 100XR oil being retractable
 - Positive stops at both ends
 - Built-in mechanical stage 1.25 Abbe condenser with iris diaphragm
 - 20-watt LED illumination
 - Dust cover and Styrofoam™ case
- SB28929 – \$339.00 5+ \$322.05

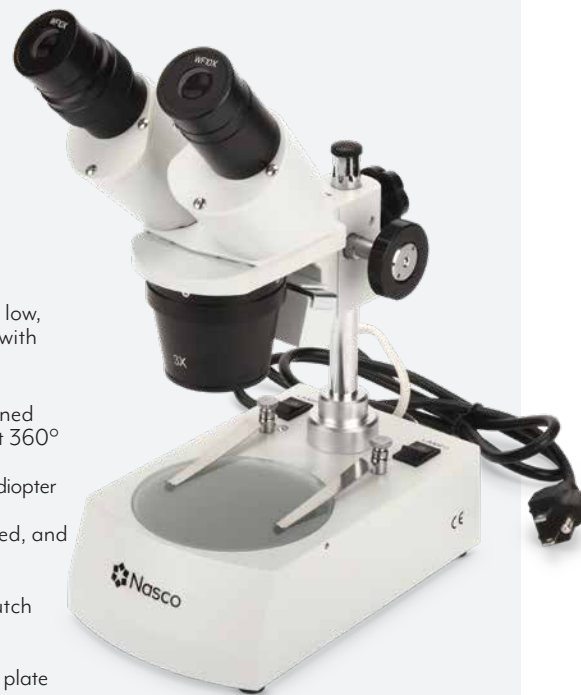

Nasco Tri-Power Stereo Microscopes

Turn tri-power objective turret to choose low, medium, or high magnification. Comes with instruction manual and vinyl dust cover.

Specifications:

- Viewing head has advanced 45° inclined design, and is post mounted to permit 360° rotation
- Locked on 10X wide-field eyepieces with diopter adjustment on one ocular tube
- Paired objectives: parfocal, parcentered, and achromatic
- LED lighting
- Rack-and-pinion focusing with slip clutch and tension adjustment
- Adjustable pole-mounted style
- 95 mm black and white reversible stage plate and frosted glass stage plate
- All metal construction

Product No.	Eyepiece	Magnification	Illumination	Voltage	Each
SB39115	10X wide-field	10X, 20X, 30X	LED corded	110V	\$287.00
SB39118	15X wide-field	30X, 45X, 60X	LED corded	110V	\$287.00
SB41022	10X wide-field	20X, 30X, 40X	LED cordless rechargeable	110V	\$317.00

Nasco Advanced Stereo Microscopes

Features the quality and versatility of larger, more expensive models, scaled to size for secondary level instruction.

Specifications:

- 45° inclined head raises, lowers, rotates 360° on pillar for off-base viewing
- Locked-on 10XWF or 15X paired wide-field eyepieces with rubber eye shields
- Interpupillary adjustment
- Diopter adjustment on one side
- Paired 2X objective
- Rack-and-pinion focusing protected by slip clutch
- Tension control adjustment eliminates drift
- LED illumination
- High-intensity, low-voltage, two-way illumination, and choice of top light only, or both top and bottom
- Frosted glass stage plate (reversible black/white stage plate also included)
- All parts lock on
- Base-mounted on/off switch
- Three-wire safety cord and plug
- Choice of 1X-2X, 1X-3X turret, or 2X-4X turret
- Dust cover

Product No.	Eyepiece	Objectives	Magnification	Rechargeable	Each
SB29050	WF15X	1X and 2X	15X and 30X	No	\$325.00
SB25264	WF15X	1X and 3X	15X and 45X	No	\$325.00



Nasco QFN Series Stereo Microscopes

Great for examining opaque or translucent specimens.

Specifications:

- 45° inclined eyepieces with interpupillary adjustment from 55 to 75 mm
- 10X wide-field eyepiece
- Working distance: 80 mm
- Includes two 75 mm stage plates (one frosted and one reversible black/white)
- Diopter control in left viewing tube
- Coated optics for crisp image and superior resolution
- Rotating objective turret
- High-intensity lighting distributes evenly
- Dust cover and instructions
- Rack-and-pinion focusing with slip clutch and tension adjustment
- Mini LED light panels on top and bottom
- Diagonally adjustable top light creates desired amount of light on stage plate
- Separate light intensity control for top and bottom illumination
- Three-way, built-in illumination allows transmitted, incident, or dual lighting

Product No.	Model	Objectives	Each
SB50597	QFN-12	10X, 20X	\$410.00
SB50595	QFN-24	20X, 40X	\$410.00



Nasco QZE/QZF Zoom Stereo Microscopes

Ideal for studying living organisms, dissecting small specimens, studying crystalline or rock structure, plus electronic and small part inspections. Smooth in operation, it has a calibrated zoom range operable on both sides of the head.

Specifications:

- 45° inclined head
- Diopter control ±5 on both ocular tubes
- Magnification: 7X-45X
- Objectives: 10X wide field
- Working distance: 90 mm
- Interpupillary adjustment from 55-75 mm
- Coated optics for crisp image, superior resolution, and excellent stereoscopic effect
- Rack-and-pinion focusing with slip clutch and tension adjustment
- 94 mm clear and reversible black/white stage plate
- Diagonally adjustable top light creates desired amount of light on stage plate
- Separate light intensity control for top and bottom illumination
- Three-way, built-in illumination allows transmitted, incident, or dual lighting
- Dust cover and instructions

QZE. Binocular head and a cluster of mini LED light panels for illuminating top and bottom. LED lights have long life and a cool temperature.

SB50598 – \$580.00

QZF. Trinocular head for CCTV or digital photomicrographic system. LED top and bottom illumination. 2.5X photo eyepiece. 35 mm camera adapter with Minolta mount.

SB50599 – \$610.00



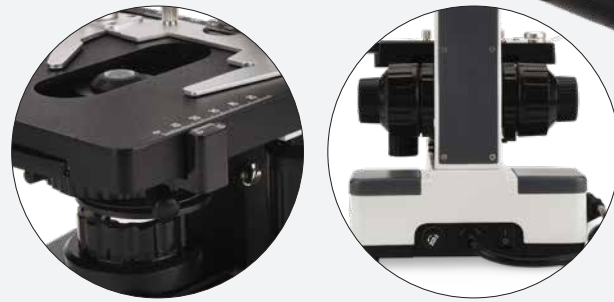

SB28945



Nasco High School Advanced Binocular Microscope (Reverse Nosepiece)

- Specifications:**
- Superior-quality locked-on 10X wide-field eyepiece with calibrated pointer
 - 360° rotating head
 - Siedentopf binocular head with diopter adjustment on left eye tube
 - DIN achromatic objectives 4X, 10X, 40XR, 100XR oil are parcentered and parfocal
 - Low position coaxial coarse and fine focus controls
 - Large work stage with built-in low position mechanical stage has X-Y travel in 1.0 mm graduations
 - Lighting has intensity control
 - Vertical adjustable 1.25 Abbe condenser with iris diaphragm
 - Tension adjustment for stage
 - Dust cover
 - Koehler illumination

Product No.	DIN Objectives	Illumination	Each
SB28945	4X, 10X, 40XR, 100XR oil	110V, 20 watt LED	\$610.00
SB28946	4X, 10X, 40XR, 100XR oil	6V, 20 watt LED	\$620.00



National Oil Immersion Microscope with Built-In Digital Camera

A powerful teaching tool for middle through high school instruction. PC and Mac® OS X® compatible.

- Specifications:**
- WF10X eyepiece
 - DIN 4X, 10X, 40XR, and 100XR (oil immersion) objectives
 - 1.25 N.A. Abbe condenser with iris diaphragm
 - Built-in mechanical stage
 - Bulb life: 50,000 hours
 - Cordless LED illumination equal to a 20-watt halogen bulb

- 3.0 megapixel digital camera
- Operates on both PC and Mac® OS X® — includes everything needed for quick Plug & Play use
- Motic Images software



**BEST
SELLER**



EXCLUDED
FROM
DISCOUNTS

Celestron® LCD Digital Microscope II

Change powers from 40X to 100X to 400X (up to 1600 with 4X digital zoom) with a turn of the three-position rotating lens turret. TV output allows television or projector displaying.

- Specifications:**
- Full-color 3½" TFT LCD screen with onboard software rotates 180°
 - Fully adjustable mechanical stage
 - Three fully achromatic objective lenses (4X, 10X, and 40X lenses on rotating turret)
 - Three-position nosepiece with click stop
 - Upper and lower, built-in adjustable LED illuminators
 - NA 0.65 condenser
 - Capture and save still images and video (built-in 5 MP camera sensor and included 1 GB SD card)
 - Use AV cable with external monitor, projector, or TV screen
 - Included accessories: dustcover, canvas carry case with shoulder strap, 5 prepared slides, and four-plug multi-country AC adapter
 - Includes Exploring Cell Curriculum; Grades 6-8: Life Science, Technology, and Mathematics
 - Complies with NGSS MS-LS1-1 and MS-LS1-2
 - 6½" x 5½" x 13"
 - Stage dimensions: 3½" x 3½"
- SB49573 — \$299.95**

Celestron® Handheld Digital Microscope Pro

Fits in the palm of your hand. Five-element, IR-cut, high-quality glass lens provides sharper images and previews. Includes professional adjustable stand. Downloadable MicroCapture Pro software works with both Macintosh® and Windows®.

- Specifications:**
- 20X-200X powers
 - 4X-160X magnification
 - 5 MP sensor takes and saves high-resolution images
 - 10 mm-infinity focuser range
 - 1 second-1/1,000 second shutter speed with trigger on USB cord
 - Adjustable still image resolution of 5 MP, 3 MP, 1.3 MP, VGA (12 MP with interpolation)
 - Video capture resolution: VGA, 30 fps
 - USB 2.0 computer interface
 - 5¾" x 4¾" x 2"
- SB49688 — \$179.95**



There's more where that came from! Scan for the full selection at nascoeducation.com

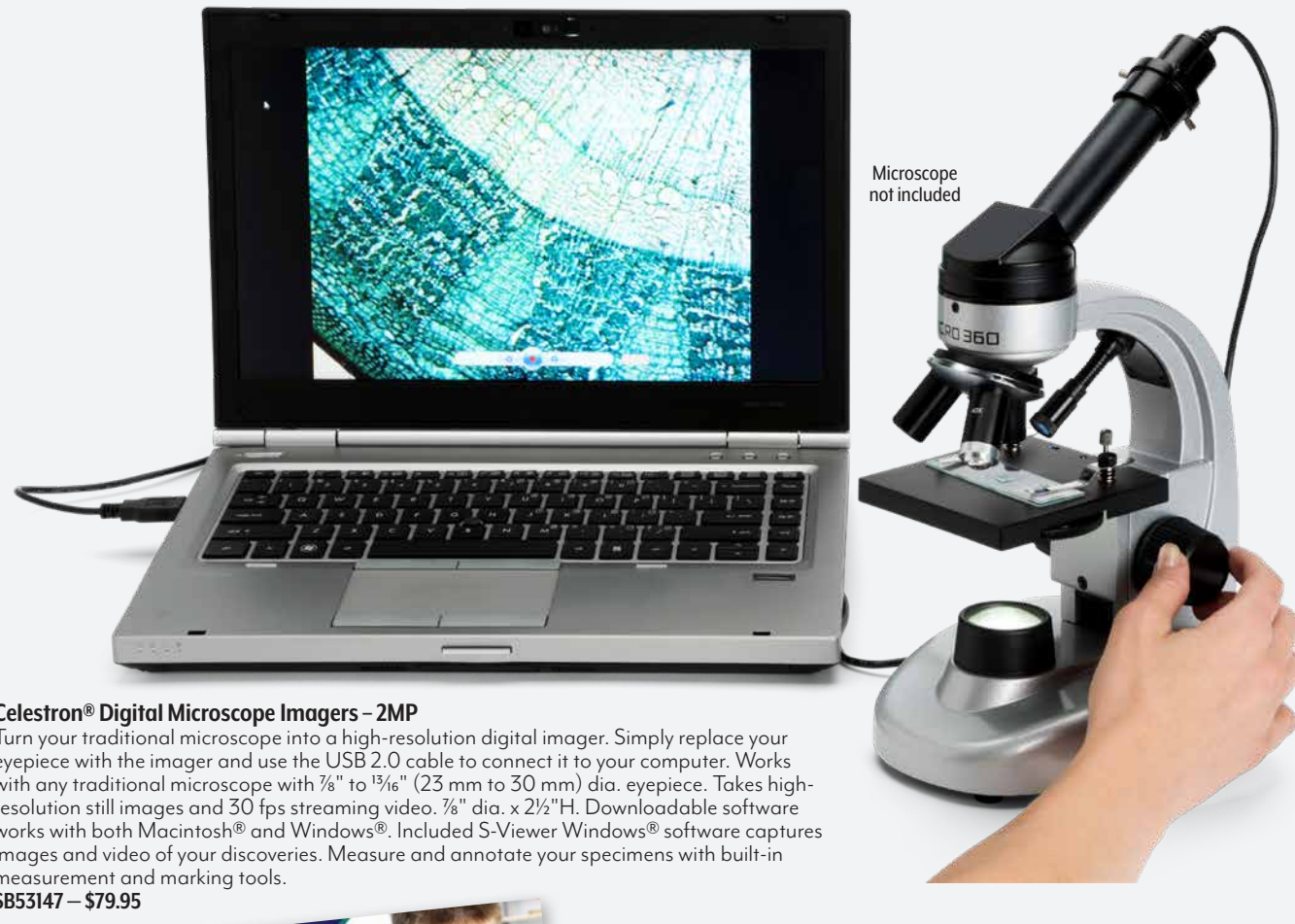

TURN YOUR MICROSCOPE INTO A DIGITAL CAMERA

Use the free MotiConnect app to view, capture, and edit live images

Celestron® Digital Microscope Imagers – 2MP

Turn your traditional microscope into a high-resolution digital imager. Simply replace your eyepiece with the imager and use the USB 2.0 cable to connect it to your computer. Works with any traditional microscope with 7/8" to 1 3/16" (23 mm to 30 mm) dia. eyepiece. Takes high-resolution still images and 30 fps streaming video. 7/8" dia. x 2 1/2"H. Downloadable software works with both Macintosh® and Windows®. Included S-Viewer Windows® software captures images and video of your discoveries. Measure and annotate your specimens with built-in measurement and marking tools.

SB53147 – \$79.95

Moticam A1 Digital 1.0 MP Microscope Camera

Turn your microscope into a camera. 1 MP resolution; display modes: 1280 x 720, 1024 x 768. Includes focusable lens, 30 mm and 38 mm eyepiece adapters, calibration slide, macro viewing tube, C-ring, USB cable, and dust cap. See specs online.

NE30392 – \$236.00



Moticam A2 Digital 2.0 MP Microscope Camera

Turn your microscope into a camera with full 2.0 MP HD resolution. Includes focusable lens, 30 mm and 38 mm eyepiece adapters, calibration slide, macro viewing tube, C-ring, USB cable, and dust cap. See specifications online.

NE30393 – \$355.00



Moticam A5 Digital 5.0 MP Microscope Camera

Turn your microscope into a camera with full 5.0 MP live resolution. Includes focusable lens, 30 mm and 38 mm eyepiece adapters, calibration slide, macro viewing tube, C-ring, USB cable, and dust cap. See specifications online.

NE30394 – \$473.00



Moticam X5 Digital 4.0 MP Microscope Camera

Turn your microscope into a high resolution 4.0 MP streaming camera that connects to Wi-Fi. Includes CS ring adaptor; 2 eyepiece adaptors to fit eyepiece O.D.s of 28 mm–38 mm; USB cable (removable) for use with switching power adapter; calibration slides; software CD Motic Images 3.0; and macro viewing tube. See specifications online.

NE30395 – \$422.00



LED Monocular Compound Microscope with Detachable Tablet

Digital compound microscope with detachable 8" LCD tablet. High-speed, full-resolution imaging technology built in. Use Wi-Fi® tablets, wireless laptops, and HD-ready LCD monitors/projectors to share live images to iOS or Android™ devices. Tablet includes preloaded Motic apps.

Microscope Specifications:

- Wide-field 10X/18 mm eyepiece
- 30° inclined forward-facing monocular head
- 4X, 10X, and 40X achromatic objectives
- 70 mW, 3.5V rechargeable LED illumination with intensity control
- Separate coarse and fine focus
- Floating and rotating stage with one-touch stage clips
- Cast aluminum, gray enamel finish

Tablet Specifications:

- 8" LCD Android™ tablet
- 1280 x 800 screen resolution
- Wi-Fi, mini HDMI, and Micro SD card connections
- 5.0 MP sensor and capture
- 1080 HDMI
- Wi-Fi resolution 2.0 MP – 5.0 MP
- 720P capture video resolution
- Built-in Motic Hub for wireless sharing

Z52095 – \$874.00



EXCLUDED FROM DISCOUNTS

Get help choosing the perfect microscope!

Use these guides to learn about the different types of microscopes and which one is right for your classroom.

To download these free guides, visit nascoeducation.com/guides and search "microscope."

BUYING GUIDE
How to choose the right microscope for your classroom

Microscopes explained
Compound microscopes
Stereo microscopes
Digital microscopes

Product No.	Product Name	Magnification	SE3501	Z52095	NE30392-95
SE3501	Nasco Compound Microscope	100X	X	X	X
SE3502	Nasco Compound Microscope with LED Light	100X	X	X	X
SE3503	Nasco Compound Microscope with LED Light and Camera	100X	X	X	X
SE3504	Nasco Compound Microscope with LED Light and Camera	100X	X	X	X
SE3505	Nasco Compound Microscope with LED Light and Camera	100X	X	X	X
SE3506	Nasco Compound Microscope with LED Light and Camera	100X	X	X	X
SE3507	Nasco Compound Microscope with LED Light and Camera	100X	X	X	X
SE3508	Nasco Compound Microscope with LED Light and Camera	100X	X	X	X
SE3509	Nasco Compound Microscope with LED Light and Camera	100X	X	X	X
SE3510	Nasco Compound Microscope with LED Light and Camera	100X	X	X	X
SE3511	Nasco Compound Microscope with LED Light and Camera	100X	X	X	X
SE3512	Nasco Compound Microscope with LED Light and Camera	100X	X	X	X
SE3513	Nasco Compound Microscope with LED Light and Camera	100X	X	X	X
SE3514	Nasco Compound Microscope with LED Light and Camera	100X	X	X	X
SE3515	Nasco Compound Microscope with LED Light and Camera	100X	X	X	X
SE3516	Nasco Compound Microscope with LED Light and Camera	100X	X	X	X
SE3517	Nasco Compound Microscope with LED Light and Camera	100X	X	X	X
SE3518	Nasco Compound Microscope with LED Light and Camera	100X	X	X	X
SE3519	Nasco Compound Microscope with LED Light and Camera	100X	X	X	X
SE3520	Nasco Compound Microscope with LED Light and Camera	100X	X	X	X
SE3521	Nasco Compound Microscope with LED Light and Camera	100X	X	X	X
SE3522	Nasco Compound Microscope with LED Light and Camera	100X	X	X	X
SE3523	Nasco Compound Microscope with LED Light and Camera	100X	X	X	X
SE3524	Nasco Compound Microscope with LED Light and Camera	100X	X	X	X
SE3525	Nasco Compound Microscope with LED Light and Camera	100X	X	X	X
SE3526	Nasco Compound Microscope with LED Light and Camera	100X	X	X	X
SE3527	Nasco Compound Microscope with LED Light and Camera	100X	X	X	X
SE3528	Nasco Compound Microscope with LED Light and Camera	100X	X	X	X
SE3529	Nasco Compound Microscope with LED Light and Camera	100X	X	X	X
SE3530	Nasco Compound Microscope with LED Light and Camera	100X	X	X	X
SE3531	Nasco Compound Microscope with LED Light and Camera	100X	X	X	X
SE3532	Nasco Compound Microscope with LED Light and Camera	100X	X	X	X
SE3533	Nasco Compound Microscope with LED Light and Camera	100X	X	X	X
SE3534	Nasco Compound Microscope with LED Light and Camera	100X	X	X	X
SE3535	Nasco Compound Microscope with LED Light and Camera	100X	X	X	X
SE3536	Nasco Compound Microscope with LED Light and Camera	100X	X	X	X
SE3537	Nasco Compound Microscope with LED Light and Camera	100X	X	X	X
SE3538	Nasco Compound Microscope with LED Light and Camera	100X	X	X	X
SE3539	Nasco Compound Microscope with LED Light and Camera	100X	X	X	X
SE3540	Nasco Compound Microscope with LED Light and Camera	100X	X	X	X
SE3541	Nasco Compound Microscope with LED Light and Camera	100X	X	X	X
SE3542	Nasco Compound Microscope with LED Light and Camera	100X	X	X	X
SE3543	Nasco Compound Microscope with LED Light and Camera	100X	X	X	X
SE3544	Nasco Compound Microscope with LED Light and Camera	100X	X	X	X
SE3545	Nasco Compound Microscope with LED Light and Camera	100X	X	X	X
SE3546	Nasco Compound Microscope with LED Light and Camera	100X	X	X	X
SE3547	Nasco Compound Microscope with LED Light and Camera	100X	X	X	X
SE3548	Nasco Compound Microscope with LED Light and Camera	100X	X	X	X
SE3549	Nasco Compound Microscope with LED Light and Camera	100X	X	X	X
SE3550	Nasco Compound Microscope with LED Light and Camera	100X	X	X	X
SE3551	Nasco Compound Microscope with LED Light and Camera	100X	X	X	X
SE3552	Nasco Compound Microscope with LED Light and Camera	100X	X	X	X
SE3553	Nasco Compound Microscope with LED Light and Camera	100X	X	X	X
SE3554	Nasco Compound Microscope with LED Light and Camera	100X	X	X	X
SE3555	Nasco Compound Microscope with LED Light and Camera	100X	X	X	X
SE3556	Nasco Compound Microscope with LED Light and Camera	100X	X	X	X
SE3557	Nasco Compound Microscope with LED Light and Camera	100X	X	X	X
SE3558	Nasco Compound Microscope with LED Light and Camera	100X	X	X	X
SE3559	Nasco Compound Microscope with LED Light and Camera	100X	X	X	X
SE3560	Nasco Compound Microscope with LED Light and Camera	100X	X	X	X
SE3561	Nasco Compound Microscope with LED Light and Camera	100X	X	X	X
SE3562	Nasco Compound Microscope with LED Light and Camera	100X	X	X	X
SE3563	Nasco Compound Microscope with LED Light and Camera	100X	X	X	X
SE3564	Nasco Compound Microscope with LED Light and Camera	100X	X	X	X
SE3565	Nasco Compound Microscope with LED Light and Camera	100X	X	X	X
SE3566	Nasco Compound Microscope with LED Light and Camera	100X	X	X	X
SE3567	Nasco Compound Microscope with LED Light and Camera	100X	X	X	X
SE3568	Nasco Compound Microscope with LED Light and Camera	100X	X	X	X
SE3569	Nasco Compound Microscope with LED Light and Camera	100X	X	X	X
SE3570	Nasco Compound Microscope with LED Light and Camera	100X	X	X	X
SE3571	Nasco Compound Microscope with LED Light and Camera	100X	X	X	X
SE3572	Nasco Compound Microscope with LED Light and Camera	100X	X	X	X
SE3573	Nasco Compound Microscope with LED Light and Camera	100X	X	X	X
SE3574	Nasco Compound Microscope with LED Light and Camera	100X	X	X	X
SE3575	Nasco Compound Microscope with LED Light and Camera	100X	X	X	X
SE3576	Nasco Compound Microscope with LED Light and Camera	100X	X	X	X
SE3577	Nasco Compound Microscope with LED Light and Camera	100X	X	X	X
SE3578	Nasco Compound Microscope with LED Light and Camera	100X	X	X	X
SE3579	Nasco Compound Microscope with LED Light and Camera	100X	X	X	X
SE3580	Nasco Compound Microscope with LED Light and Camera	100X	X	X	X
SE3581	Nasco Compound Microscope with LED Light and Camera	100X	X	X	X
SE3582	Nasco Compound Microscope with LED Light and Camera	100X	X	X	X
SE3583	Nasco Compound Microscope with LED Light and Camera	100X	X	X	X
SE3584	Nasco Compound Microscope with LED Light and Camera	100X	X	X	X
SE3585	Nasco Compound Microscope with LED Light and Camera	100X	X	X	X
SE3586	Nasco Compound Microscope with LED Light and Camera	100X	X	X	X
SE3587	Nasco Compound Microscope with LED Light and Camera	100X	X	X	X
SE3588	Nasco Compound Microscope with LED Light and Camera	100X	X	X	X
SE3589	Nasco Compound Microscope with LED Light and Camera	100X	X	X	X
SE3590	Nasco Compound Microscope with LED Light and Camera	100X	X	X	X
SE3591	Nasco Compound Microscope with LED Light and Camera	100X	X	X	X
SE3592	Nasco Compound Microscope with LED Light and Camera	100X	X	X	X
SE3593	Nasco Compound Microscope with LED Light and Camera	100X	X	X	X
SE3594	Nasco Compound Microscope with LED Light and Camera	100X	X	X	X
SE3595	Nasco Compound Microscope with LED Light and Camera	100X	X	X	X
SE3596	Nasco Compound Microscope with LED Light and Camera	100X	X	X	X
SE3597	Nasco Compound Microscope with LED Light and Camera	100X	X	X	X
SE3598	Nasco Compound Microscope with LED Light and Camera	100X	X	X	X
SE3599	Nasco Compound Microscope with LED Light and Camera	100X	X	X	X
SE3600	Nasco Compound Microscope with LED Light and Camera	100X	X	X	X

Have questions? We're here to help! Contact us today.
phone: 1.800.558.9595
email: custserv@nascoeducation.com
online: nascoeducation.com

EXCLUDED FROM DISCOUNTS



NexYZ 3-Axis Universal Smartphone Adapter

Connects your smartphone to telescopes, spotting scopes, binoculars, monoculars, and microscopes to capture images and video. Directional knobs (x-, y-, and z-axis) perfectly align your phone's camera with the eyepiece in seconds. Fits any eyepiece from 25–60 mm with included adapter ring. Adjustable platform fits any smartphone device. Control x-, y-, and z-axis.

SB53069 — \$74.95



Universal Smartphone Optics Adapter

Place your smartphone or tablet (with or without a case) into phone clamp, then attach to any optic. Self-centering adapter fits any 28–58 mm eyepiece. Glow-in-the-dark rubber makes it easy to use and set up in low-light conditions. Squeeze-and-release connection. Protective case. 5³/₁₆" x 2¹/₂" x 5¹/₁₆".

EL12172 — \$72.95

Create a mobile microscope with any smartphone



Smartphone Inspector

Transform any smartphone or tablet into a mobile microscope. Zoom in, take pictures, or capture video close up. 60X illumination, LED and UV lights, adjustable viewing distance, clip, and carrying pouch.

SB52507 — \$10.25



MicroMax LED™ Pocket Microscope

Extremely lightweight and portable.

- Built-in LED light
- 60X–100X magnification
- Rubberized eyepiece

SB50625 — \$15.99



Illuminated Zoom Pocket Microscope

Precision illuminated zoom microscope.

- 60–100X magnification power
- Adjust focus by turning wheel
- 1³/₄" x 5⁵/₈" L
- Vinyl storage cover
- Requires 2 "AA" batteries (not included)

SB20198 — \$20.50

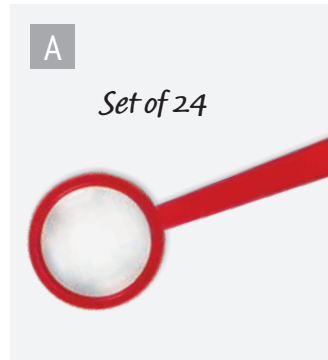

A. **Magnifying Lens**
Set of 24



E. **Hand Magnifier**



B. **Round Glass Magnifiers**



C. **Round Glass Magnifiers**



D. **Hand Magnifier**



F. **Large Dual Magnifiers**
Set of 12



G. **Tri-Lens Hand Magnifier**



H. **BugLoupe™**



I. **Tripod Magnifier**



J. **Acrylic Magnifier Boxes**



K. **Triple Folding Pocket Magnifiers**



L. **Pocket Loupe**

A. Magnifying Lens
Plastic frame. 3X magnification. Set of 24 assorted colors. 5¹/₂" L x 2" W. **CHOKING HAZARD (I).** Not for under 3 yrs.
SB30348 — \$55.49

B. Round Glass Magnifiers
Glass with plastic frame and handle designed for better conformity to natural grip of hand. 2X power.
SB16443 2" dia. — \$2.50
SB16444 3" dia. — \$5.00

C. Round Glass Magnifiers
General-purpose glass magnifiers suitable for routine examination of biological and geological specimens. Chrome rims with black plastic handles. 2–2.5X.
SB16441 3" dia. — \$6.50
SB16442 4" dia. — \$6.75

D. Hand Magnifier
Student magnifier molded of optical grade acrylic. 3X magnification with a 1³/₈" dia. lens.
SB18007 — \$1.50

E. Hand Magnifier
Dual magnifier, 3X and 6X. Plastic frames. 4¹/₂" L.
SB18031 — \$1.65

F. Large Dual Magnifiers
Plastic body with 2 glass lenses. 5X lens with 2¹/₈" dia. viewing area works well for basic magnification, while 3³/₄" lens with 8X power is ideal for providing extra detail while remaining separate from the main lens. Pkg. of 12; 6¹/₄" L.
SB48968 — \$14.95

G. Tri-Lens Hand Magnifier
Plastic. 2X, 6X, and 8X magnification. Lens diameter: 25 mm.
SB26577 — \$2.35

H. BugLoupe™
This magnifier allows you to see the finest details. Pre-focused for quick, easy viewing at 5X power. 4" x 4" x 3".
SB33381 — \$14.95

I. Tripod Magnifier
Black aluminum tripod. Plastic lens holder has worm screw adjustment. Two 1" precision polished biconvex lenses magnify 10X.
SA04452 — \$8.95

J. Acrylic Magnifier Boxes
Acrylic box has molded magnifier with 4X power that snaps on and off. 1" x 1" x 3³/₄".
SB10304 — \$1.90

Large Magnifier Box. Big 1¹/₂" cube with magnifier slip lid.
SB10305 — \$2.95

K. Triple Folding Pocket Magnifiers
Triple-lens magnifier with three 5X lenses for possible magnifications of 5X, 10X, and 15X. Lens diameter: 22 mm.
SB26079 — \$4.75

L. Pocket Loupe
Foldout doublet magnifier with 10X lens. Length open 2¹/₂" (63 mm), lens aperture 1¹/₂" (13 mm), focal length 1" (25 mm). **CHOKING HAZARD (I).** Not for under 3 yrs.
SA09134 — \$8.95

See page 3 for complete Choking Hazard Label Information.

Nasco Sticky Slides

No more broken glass slides, scratchy plastic, or hard-to-use cover slips. Simply remove protective covering, stick specimen to slide, and view. Reusable. 6" strips are perforated at 1½". A 1½" slide works well for elementary standard mirror or prism-optic microscopes. A 3" (or more) slide works well for stereo microscopes. Pkg. of 5 strips yields 20 slides. **CHOKING HAZARD (1).** Not for under 3 yrs.

SB38432 — \$13.50

Visit nascoeducation.com to watch a demonstration

EASY AS 1-2-3
Non-glass, bendable, and unbreakable

ONLY AT
NASCO



Peel off covering



Specimen sticks to slide



Slide sticks to stage



Plastic



B

Plastic



C

Glass



D

Plastic



E

Rounded glass

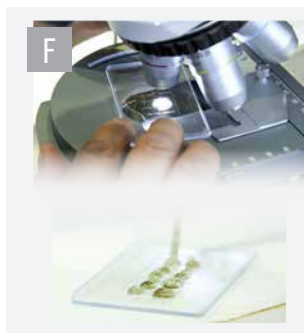

F



BEST SELLER

G

Glass



H

Glass

A. Plastic Slide Lab Pack

50 unbreakable 1" x 3" slides and cover slips (22 mm square), as well as a booklet of 50 sheets of lens tissue.

SB16377 — \$12.50

B. Plastic Micro Slides

Made from optically clear Rinzl vinyl. Will not break, scratch, or cut fingers. For all types of mounting. Disposable. 1" x 3" x .0180-0.22 thick. Box of 144.

SB14080 — \$8.95

C. Glass Square Micro Cover Glasses

Ideal for use in labs where the best technical quality possible is desired at budget prices. No. 1 thickness range: 0.13-0.17 mm. No. 2 thickness range: 0.17-0.22 mm. Boxes of 100.

18 x 18 mm, No. 1 Thickness
S08463 — \$3.60

22 x 22 mm, No. 2 Thickness
S08465 — \$3.95

22 x 22 mm, No. 1 Thickness
S08464 — \$9.95

D. Plastic Coverslips

Unbreakable, flexible, and non-curling. Boxes of 100.

SB47348 18 x 18 mm — \$2.95

SB47349 22 x 22 mm — \$3.75

E. Glass Microscope Slides with Rounded Corners

No sharp corners. Pre-cleaned slides are made of quality sheet glass with ground edges. 75 x 25 x 1.0-1.2 mm thick. Box of 72.

SB50588 — \$7.00

F. LiveSlides®

Perfect for maintaining a shallow depth of field. Configuration has partitions to keep specimens in the viewing area. Made of reusable Makrolon® polycarbonate and is impact resistant.

Can be used as both a traditional and digital slide. Includes 2 reusable Makrolon® coverslips.
SB53154 — \$3.75

G. Glass Microscope Slides

Clear. 1" x 3" x 1.0 mm thick. Box of 72.

SA04463 — \$4.95

H. Glass Microscope Slides — Single Concave

Clear. 1" x 3" x 1.2-1.3 mm thick; 16 mm dia.; 0.50 mm depth.

SB15360 Box of 12 — \$5.50

SB15361 Box of 72 — \$22.50



Try our quick order feature for faster ordering on nascoeducation.com

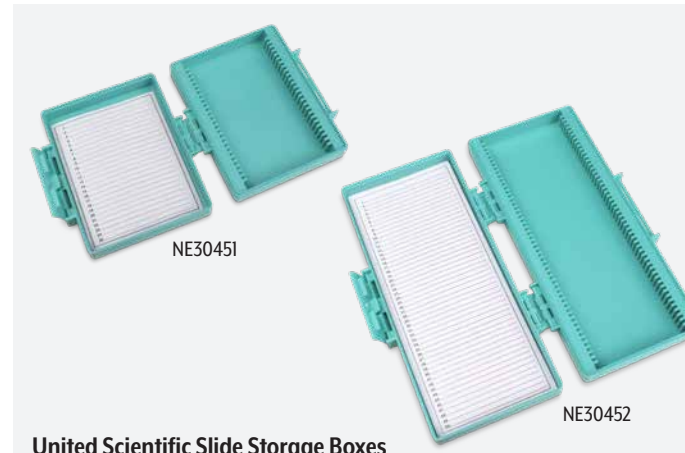

United Scientific Slide Storage Boxes

Sturdy two-piece boxes hold standard 3" x 1" microscope slides. Feature engraved numbering and reference card. Molded high-impact polystyrene.

NE30451 25 Slides — \$4.25

NE30452 50 Slides — \$5.55



General Biology Survey Slide Set

Surveys major animal phyla and plant divisions, explores human and mammalian tissues, and compares and contrasts mono and dicot roots, stems, and leaves. Set of 100 in 9" x 8" x 2" hardwood storage box.

SL10017 — \$280.00

BEST SELLER



Prepared Slides Set

Set of 25 slides in wooden storage box. Mitoses in plants: pollen grains, w.m.; amoeba, w.m.; yeast cells, w.m.; green algae/spirogyra, w.m.; letter "e", tape worm, t.s.; silk fabric, w.m.; lily leaf, v.s.; mammal lung, t.s.; meiosis in animals; Aves feather, w.m.; lily stamen, t.s.; mammal hair, w.m.; mosquito mouth parts, w.m.; housefly mouth parts, w.m.; frog blood smear; human blood smear; onion cells, w.m.; hibiscus stem, t.s.; wool fabric, w.m.; fish scale, w.m.; skeletal muscle, w.m.; herbaceous stem, young, t.s.; and skin cells, v.s.

SL10016 — \$69.95

Microscope Slides

Key to Abbreviations:

- w.m. — whole mount
- c.s. — cross section
- t.s. — transverse section
- l.s. — longitudinal section
- sec. — section of unspecified orientation
- sq. or sm. — squash or smear preparation
- o.s.s. — on single slide



Slides for the beginner

SL10018

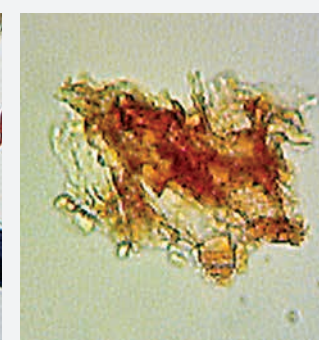

SL10019

Product No.	Description	Each
SL10018	Colored thread, w. m. Yellow on blue on red. Threads crossed, designed to aid in the teaching of focusing of a microscope	\$3.15
SL10019	Cork section	\$3.55
SL10023	Letter "e", w.m. Useful for introducing students to the microscope by demonstrating reversal of direction and image	\$3.25



Four specimens per slide

Enclosed Prepared Slides — Complete 48-Specimen Set

Prepared glass slides of permanently preserved specimens. Safe glass slides protected for safety. Set includes different examples of pollen/spores, textiles, insects, tiny creatures, animals, and plants. Contains 12 slides, 48 specimens. Four labeled specimens per slide.

SL10012 — \$24.95

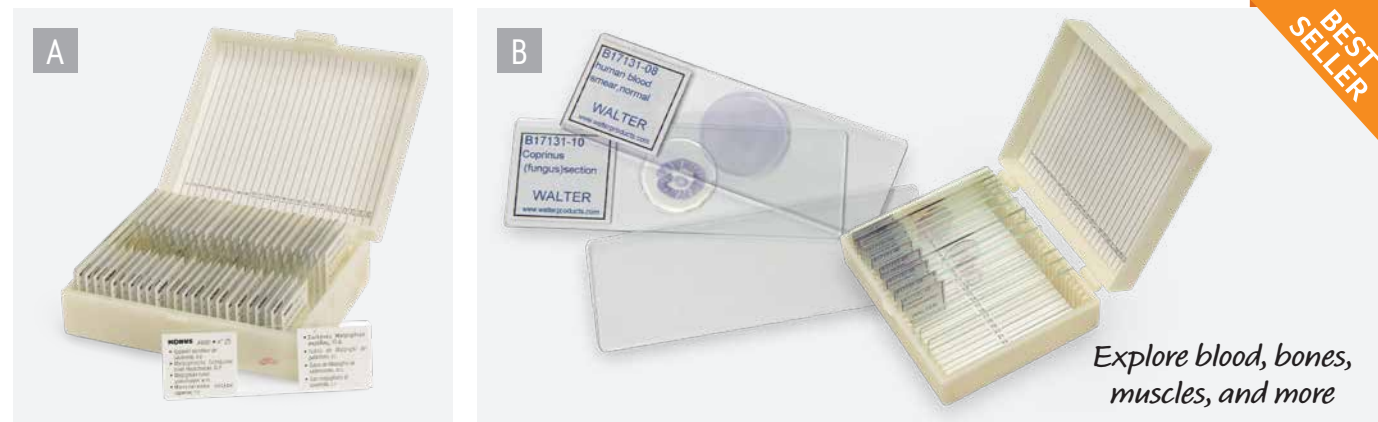

BEST SELLER

Explore blood, bones, muscles, and more

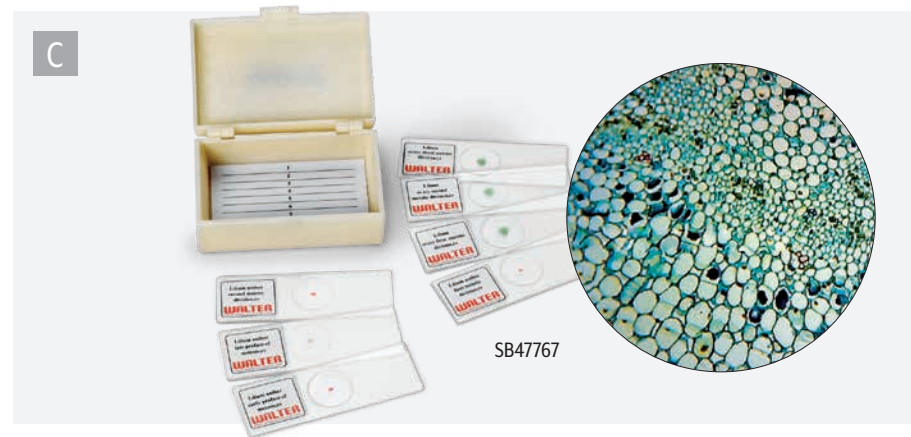

SB47767



NEW



A. Student Grade Slide Sets

Each slide has a description of the specimen in 8 languages. Sets of 25 in plastic case.

- SB47786** Insects
- SB47787** General Biology
- SB47788** The Cell & Animal Tissue
- SB47789** Invertebrate and Insects Set — \$37.95

B. Student Grade Life Science Slide Set

These 13 slides include normal human blood smear; blood smear of sickle cell anemia cells; ground human bone; *Coprinus* (fungus) section; foliose thallus and apothecia section; *Physcia stellaris*, hair (1 each of cat, human, and sheep); leaf section, *Syringa vulgaris* (lily), striated human muscle; roof tip section of *Allium* (onion) showing mitosis; Caucasian human skin; and 3 blank slides. Comes with box to hold 25 slides.

SB52950 — \$46.00

C. Student Grade Slide Sets

1" x 3" slides labeled and stored in slotted container.

Human Pathology. Set of 12 slides includes human blood anemia, lung cell cancer, capillary tumor, gallbladder cholecystitis, lung tuberculosis, intestines adenoma, and 6 other specimens. **SB47764 — \$73.00**

Lilium Meiosis. Set of 7 slides covers different phases and divisions of *Lilium* ovary and *Lilium* anther. **SB47767 — \$52.95**

D. Lens Paper

Recommended for cleaning microscope slides, optical instruments, and other lenses. 50 sheets; 4" x 6". **SB48370 — \$2.10**

E. My First Lab™ Prepared Slides

72 specimens (24 slides with 3 specimens each), including plants, insects, pollen, fibers, and many more! Shatterproof plastic. Each slide: 3 mm x 1 mm x 1 mm. **NE30601 — \$33.00**

F. Bibulous Paper

Highly absorbent, white fiber paper for drying slides and other small lab glass items. 4" x 6" booklet contains 50 sheets. **SB08543 — \$3.05**

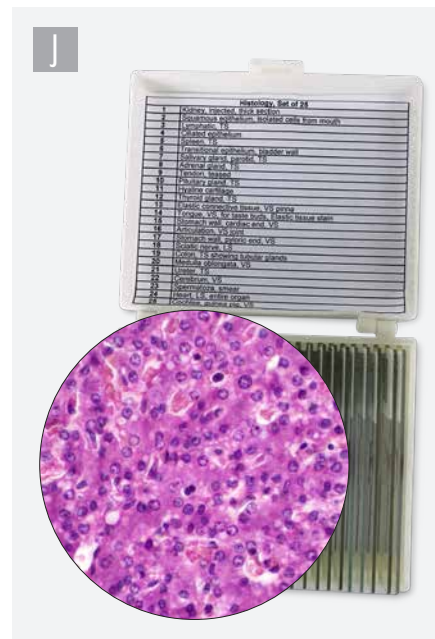
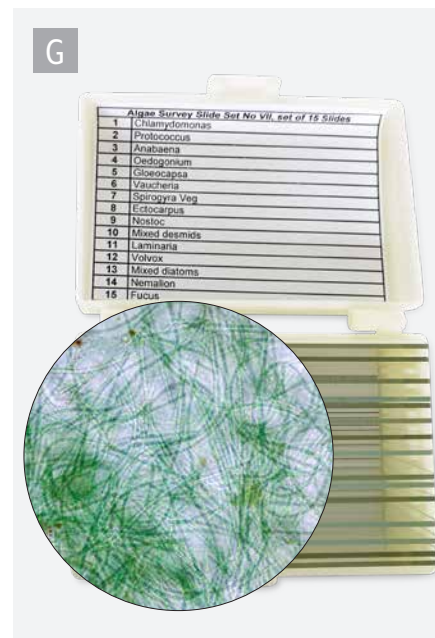

G. United Scientific Algae Survey Slide Set

Gr. 5+ Set of glass prepared microscope slides specific to the study of algae. Includes 15 slides in a plastic case. For more details, visit nascoeducation.com. **NE30307 — \$49.95**

H. United Scientific Bacteria Survey Slide Set

Gr. 5+ Set of glass prepared microscope slides specific to the study of bacteria. Includes 12 slides in a plastic case. For more details, visit nascoeducation.com. **NE30308 — \$46.50**

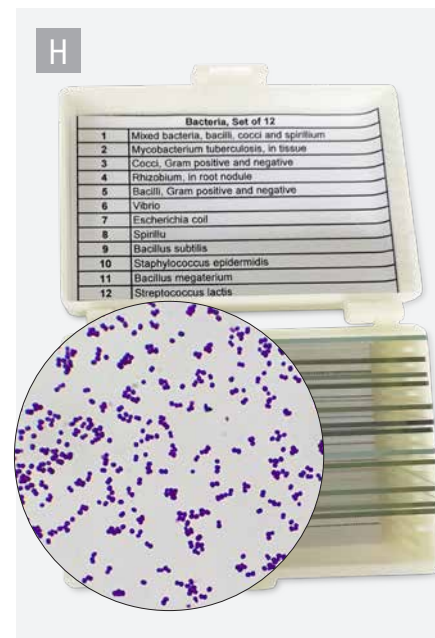

I. United Scientific Basic Botany Slide Set

Gr. 5+ Set of glass prepared microscope slides specific to the study of botany. Includes 25 slides in a plastic case. For more details, visit nascoeducation.com. **NE30309 — \$50.50**

J. United Scientific Histology Slide Set

Gr. 5+ Set of glass prepared microscope slides specific to the study of histology. Includes 25 slides in a plastic case. For more details, visit nascoeducation.com. **NE30310 — \$89.95**



K. United Scientific Basic Plant Anatomy Slide Set

Gr. 5+ Set of glass prepared microscope slides specific to the study of plant anatomy. Includes 20 slides in a plastic case. For more details, visit nascoeducation.com. **NE30311 — \$41.75**

L. United Scientific Protozoa and Algae Slide Set

Gr. 5+ Set of glass prepared microscope slides specific to the study of protozoa and algae. Includes 20 slides in a plastic case. For more details, visit nascoeducation.com. **NE30312 — \$77.25**

For complete descriptions, visit nascoeducation.com

CHEMISTRY

Atoms, isotopes, organic structures, DNA, chemical reactions, elements, inorganics, molecules, compounds — chemistry explores it all!

Get your students excited to learn with hands-on kits, molecular models, chemicals, and more inside of the lab.

- Periodic Tables **102-103**
- Model Kits **104-105**
- Lab Kits **106-112**
- Chemicals **113-116**
- Chemical Storage **117**

BEST SELLER

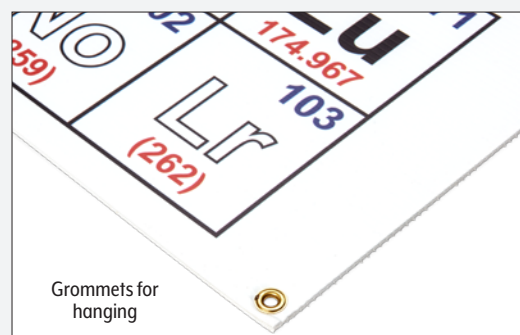
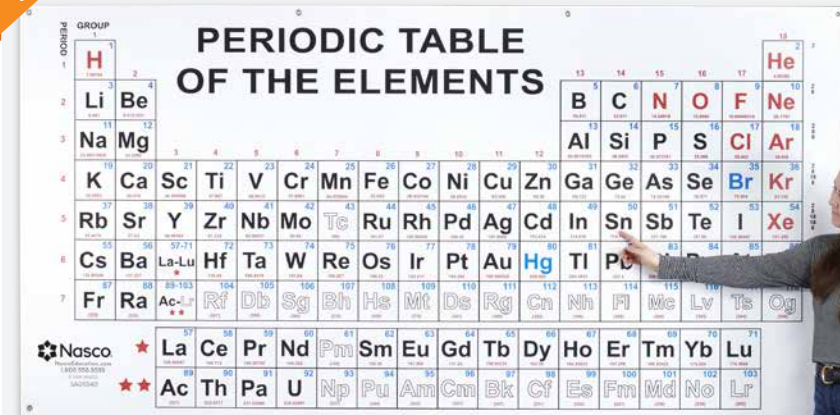

Nasco Basic Periodic Table
Large size, type styles, and three-color printing ensure maximum visibility. 118 elements. Corrugated plastic folds into quarters for storage or tabletop use. Grommets for hanging on wall or from ceiling. **SA05540** 96" x 48" — \$175.00
SB53270 58" x 42" — \$139.95

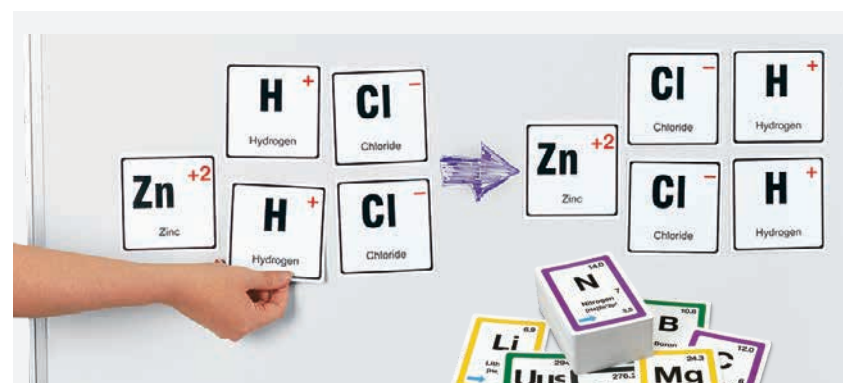

Stick to Science
Cards stick to almost all blackboards/whiteboards.

Chemical Nomenclature Cards. Gr. 7+ Designed for both nomenclature systems used today. 4 cards are blank. 144 write-and-wipe magnetic cards (4" x 4") of the most common cations and anions and teacher's guide. **SB48578** — \$52.95

Magnetic Periodic Table Investigation. Gr. 5-10 Use to investigate the first 20 elements of the periodic table. Elements 1-20, hydride (H-), and 14 additional cards (4 hydrogen; 3 oxygen; 2 each of sodium, potassium, and chlorine; and 1 fluorine). **SB47691** — \$27.95

BEST SELLER

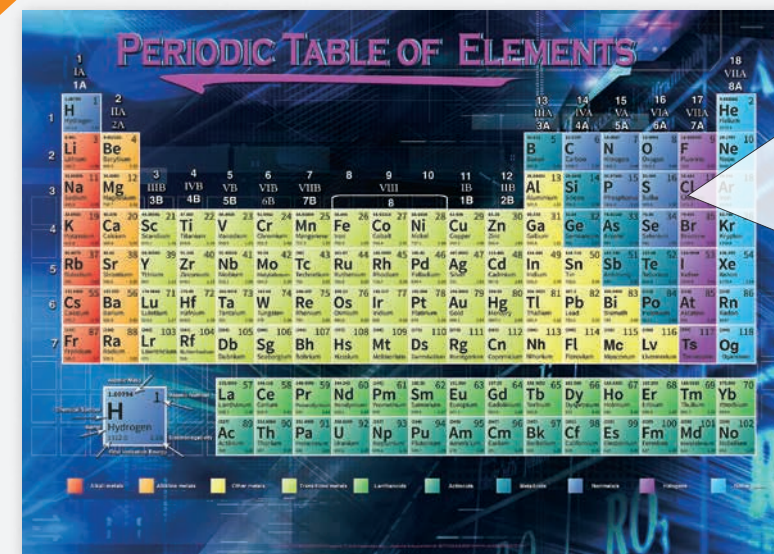

30.973761908	15	32.065	16	35.453	17	39.948	18
P Phosphorus		S Sulfur		Cl Chlorine		Ar Iron	
1511.8	2.18	959.6	2.58	1251.2	2.18	1520.6	
74.92160	33	78.96	34	79.904	35	83.798	36
As Arsenic		Se Selenium		Br Bromine		Kr Krypton	
947	2.18	941	2.58	1137.0	2.96	1350.8	
121.760	51	127.60	52	126.9044	53	131.293	54
Sb Antimony		Te Tellurium		I Iodine		Xe Xenon	
834	2.05	869.3	2.10	1008.4	2.66	1170.4	2.60

Color-coded elements

Super Size Periodic Table of Elements Poster
Gr. 9+ Key information for 118 elements. Color-coded for understanding relationships among elements. Instructions on reading the table, information on element composition, and grommets for easy hanging. Vinyl. 48" x 64". **SB46808** — \$194.95



Elements & the Periodic Table Kit
Gr. 6+ These two activities have students compare data on physical and chemical properties of 14 elements, sort them into groups based on common properties, learn the difference between elements and compounds, and more. **SB46822** — \$122.95



Photographic Periodic Table
Gr. 2+ Shows photos of 118 elements that represent their diversity of texture, crystal structure, and color. Reverse side has technical data about each element along with a brief description. 53"W x 27"H. **SB43808** — \$36.95

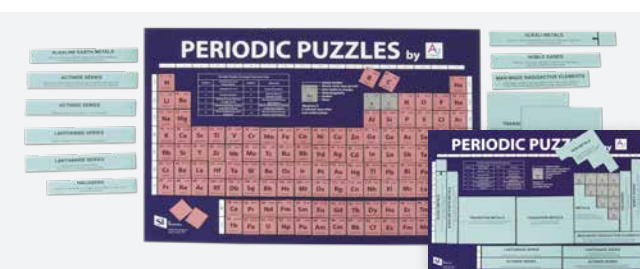

Periodic Puzzles
Gr. 7+ Teach element recognition and patterns. Magnetic tiles stick to the periodic table. Table, 118 element tiles, 13 grouping tiles, and teacher's guide. **CHOKING HAZARD (I)**. Not for under 3 yrs. **SB53070** — \$25.95



The Photographic Card Deck of the Elements
Gr. 3+ These 126 cards (5" x 5") feature all 118 elements, plus additional cards that explain the arrangement of the periodic table, present the elements sorted by various properties, and suggest activities and uses for the cards. **SB46736** — \$24.95

See page 3 for complete Choking Hazard Label Information.

A

Teacher Set

Student Set

BEST SELLER

B

C

Junior

Senior

D

E

A. Molymod® Molecular Model Sets for Inorganic and Organic Chemistry
Sets contain the appropriate numbers of atom parts and links to make a particular structure. Made of self-colored plastic, color-coded and compatible. Δ CHOKING HAZARD (1). Not for under 3 yrs.

Teacher Set. 108 atoms. **Student Set.** 52 atoms.
SB40831 – \$59.95 SB40832 – \$29.95

B. Molecules of Life Kit
Study the basic structure of the chemistry of carbohydrates, lipids, and proteins by constructing 3-D models. Over 1,800 molecular components. For 30 students. Includes 12 packages. Δ CHOKING HAZARD (1). Not for under 3 yrs.
SBI3756 – \$177.95

C. Atomic Model Set
Hands-on project helps students better understand atoms. Δ CHOKING HAZARD (1). Not for under 3 yrs.
Junior. 26 connecting lugs, 37 connectors (3 lengths), 12 black balls, 6 blue balls, 10 orange balls (2 sizes), 10 yellow balls (2 sizes), 5 green balls, and 6 red balls.
SB46610 – \$30.50

Senior. 185 connectors in assorted sizes, 60 black balls (with 3 bond representations), 125 white balls, 30 red balls, 25 green balls, 50 yellow balls (2 sizes), 50 orange balls (2 sizes), and 30 blue balls.
SB48267 – \$132.95

D. BRIGHT Science Kit™
Use to make atoms, isotopes, and ions. One BRIGHT Teacher Atom™ (holds 20 each of the protons, electrons, and neutrons) for use on a classroom whiteboard and 8 BRIGHT Atoms™ (hold 30 each of the protons, electrons, and neutrons) for student use. Δ CHOKING HAZARD (1). Not for under 3 yrs.
SB46626 – \$500.00

E. BRIGHT Atom™ Model
Let students make their own atoms, isotopes, and ions. Use both surfaces to make atoms. Atoms measure 1/2" dia. Δ CHOKING HAZARD (1). Not for under 3 yrs.
SB45486 – \$49.95

BEST SELLER

Atoms connect magnetically

Thames & Kosmos Happy Atoms
Gr. 5+ Assemble molecular models using atom models that stick together with magnets. Use the app for iPad® and iPhone® to snap pictures of created models to identify the molecule. App recognizes tens of thousands of models and presents detailed information about 120 of the most important molecules. Requires iPad® or iPhone® (not included).
Complete Set. 52 atom models represent 16 elements.
EL14902 – \$155.00
Educator's Bundle. 250 atom models represent 16 elements.
SB52560 – \$775.00

Thames & Kosmos Happy Atoms 2D: Interactive Chemistry Puzzles. In this 2D version, students can build more than 17,000 molecules and scan them with the app to identify them and learn in-depth information. Includes printed manual. Δ CHOKING HAZARD (4). Not for under 3 yrs.
NE30223 – \$22.95

The Atom
Gr. 7+ See and touch atom parts while “building” complete atoms up to atomic number 10. 16" x 16" background.
With Powder-Coated Steel Background. Holes are provided for hanging on blackboard or other hooks.
SB22526 – \$90.00

With Magnetic Vinyl Background. Magnetic back will stick on most blackboards.
SB28840 – \$66.95

Water Kits
Gr. 6+ Each cup includes pieces for 12 water molecules, 1 sodium, 1 chloride, 1 ethane, and 1 hydroxyl group. All atoms are magnetized to reflect positive or negative charges (except for nonpolar ethane). Meets STEM and NGSS. NOTE: Only available in the U.S. Δ CHOKING HAZARD (1). Not for under 3 yrs.
SB53356 1-Cup Set – \$62.00 SB53357 10-Cup Set – \$580.00
SB49640 6-Cup Set – \$360.00

Model Plus: The Atom
Gr. 6–10 An up-to-date model of the Bohr atom with a “fuzzy cloud” of electrons rather than neat elliptical orbits. Nontoxic EVA foam. 19" x 13" x 3". Δ CHOKING HAZARD (1). Not for under 3 yrs.
SB39250 – \$79.95

NEW

Mole Set
Teach students about moles in a visual, hands-on way with this set of 4 metal bars (copper, iron, zinc, and aluminum) that each represent one mole. Bars measure 1/2" H x 1/2" L x 1 1/8" W to 2 1/2" W.
NE30570 – \$24.95

BEST SELLER



ONLY AT NASCO

Nasco Chemistry Centers Kit
Gr. 4–5 Meets standards, teaches scientific method in a practical way, and encourages cooperative learning. Topics include states of matter; mixtures, solutions, emulsions, and surface tension; crystals; chromatography; and density. **⚠ CHOKING HAZARD (I).** Not for under 3 yrs.
SB48564 – \$164.95

Use chemistry to make your own root beer!



Mr. RootBeer® Kit
 Kit contains all the essential ingredients to brew two batches of root beer in 3 days (each batch makes 1 gallon). Learn the chemistry behind this soda, as well as some fun facts and history. Unlike store-bought root beer, this is naturally carbonated, giving it less fizz and a smoother, creamier taste. Includes root beer mix, dry yeast, flavor crystals, no-rinse cleanser, 4 reusable plastic bottles (FDA approved for food and beverage), 4 reusable plastic pressure-relief caps (designed to release excessive pressure as a safety measure), 4 labels, funnel, guide, and instructions. **NOTE:** Due to this carbonation process, your root beer will contain trace amounts of alcohol (approximately 1/2 of 1% ABV).
C32807 – \$31.99



American Chemical Society®: Chemistry – Investigating Your World Lab Activity
Gr. 6+ Includes 4 lessons investigating chemical changes while giving students a sense of the many ways that chemistry is used to benefit mankind. Activities include the production of gas, chemistry and color change, formation of a precipitate, and temperature change of chemical reactions. For 24 students working in groups.
SB52488 – \$150.95

Chemistry Bit Set
 Set of 14 mini-chemistry kits. Topics include polarity of water, spectrum, crystal gel, and more. Each includes several activities and experiments, enough material for several trials, and instructions. **⚠ CHOKING HAZARD (I).** Not for under 3 yrs.
SB39050 – \$43.95



Thames & Kosmos® Chem C3000
Gr. 7+ By performing more than 387 fascinating experiments in this well-balanced curriculum, students learn first-hand every fundamental principle of the essential science.
◆ SB45947 – \$264.95



Polymers – Making Fluorescent Worms Kit
Gr. 4+ Learn about polymers and cross-linking by making gel-like polymer “worms.” Enough material to make several dozen polymer worms.
SB51064 – \$50.00



Elements, Compounds, and Mixtures
Gr. 7–10 Separate a mixture of an element and a compound using solubility and filtration; a mixture of two compounds using solubility and filtration; a mixture using chromatography; and a mixture by evaporation. Required, but not included: balance and laboratory supplies. For 24 students working in groups of 4. Meets National Standards for grades 7–10.
◆ SB39434 – \$106.00



Thames & Kosmos® Chemistry C500
Gr. 4+ Through fun activities like writing messages in invisible ink or performing “magic” tricks, students can learn about reactions between solids, liquids, and gases; the effects of acids and bases; and how to use common lab tools. Includes 48-page manual and equipment and chemicals for 28 safe experiments.
NE30401 – \$35.95



Thames & Kosmos® Chemistry C1000
Gr. 4+ 80-page manual introduces famous chemists, teaches how to set up a lab space and safely handle lab equipment and chemicals, and includes detailed instructions for 125 experiments. Includes all the equipment and chemicals you need.
NE30402 – \$64.95



Chemiluminescence Lab Activity
Gr. 7+ Create a chemiluminescent reaction, then observe the blue glow of the reaction, which lasts for over 10 minutes. For 15 groups.
SB46579 – \$62.95



The Cool Blue Light Experiment Kit
Gr. 4+ Make a cool blue light appear in the dark. Learn about how fireflies glow, chemiluminescence, and the real quantum leap. **⚠ CHOKING HAZARD (I).** Not for under 3 yrs.
SB31106 – \$10.95

⚠ See page 3 for complete Choking Hazard Label Information.

◆ DOT hazardous material ⚡ Subject to DOT hazardous material surcharge.



Innovating Science® Elephant Toothpaste Individual Student Kit
Gr. 7–12 Students will learn about the effects of catalysts on a chemical reaction and phase changes, as they create a whole bunch of foam. For in-class or at-home learning. **CHOKING HAZARD (I)**. Not for under 3 yrs.
SB53420 – \$11.25

Acids, Bases, and Salts – 26 Investigations

Gr. 7–9 Learn to recognize and prepare acidic and basic solutions, the chemical composition and preparation of salts, acid and base properties of salts, and more. Includes digital teacher guide.
◆ SB21517 – \$194.95

The Nature of Chemical Change – 16 Investigations

Gr. 7–9 Learn about observable events associated with chemical change, basis for distinguishing between chemical and physical change, and more. Includes digital teacher guide. **CHOKING HAZARD (I)**. Not for under 3 yrs.
◆ SB20216 – \$122.95

Types of Chemical Reactions – 16 Investigations

Gr. 7–9 Learn the basis for recognizing 4 types of chemical reactions, rules for writing balanced equations to describe chemical reactions, and more. Includes digital teacher guide. **CHOKING HAZARD (I)**. Not for under 3 yrs.
◆ SB20218 – \$144.95



BEST SELLER
ONLY AT NASCO

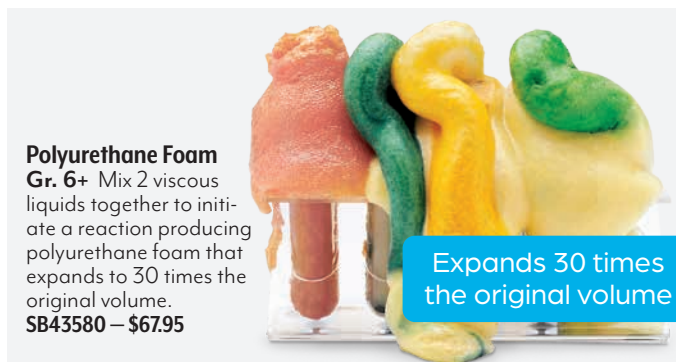

Polyurethane Foam
Gr. 6+ Mix 2 viscous liquids together to initiate a reaction producing polyurethane foam that expands to 30 times the original volume.
SB43580 – \$67.95

Expands 30 times the original volume

Foam City – The Catalytic Decomposition of Hydrogen Peroxide

Gr. 7+ Produce a large quantity of foam by adding detergent and potassium iodide to hydrogen peroxide.
◆ SB49308 – \$30.95



Chemical Properties

Gr. 9+ Test the chemical properties of 7 different solutions by mixing them in every possible combination and observing their reactions, then use the info to identify any of the 4 unknowns. For 24 students working in groups of 4. Meets National Standards for grades 9-12. **CHOKING HAZARD (I)**. Not for under 3 yrs.
◆ SB43441 – \$208.95



Exothermic/Endothermic Combination

Gr. 6+ Reactions are safely carried out in plastic bags. Enough for 5 demonstrations.
◆ SB43571 – \$45.95

Chemical Observation Set

Gr. 10+ Study the similarities and differences between 23 elements. Periodic table included.
◆ SB47044 – \$129.95



General Chemistry: Acids, Bases, and the pH Scale Classroom Kit

Gr. 7–12 Examine the effects of acids and bases on several chemical pH indicators, determine the pH of several common household materials, and use the knowledge gained to determine the composition of 4 unknown clear solutions. For 15 groups.
◆ SB46576 – \$94.95

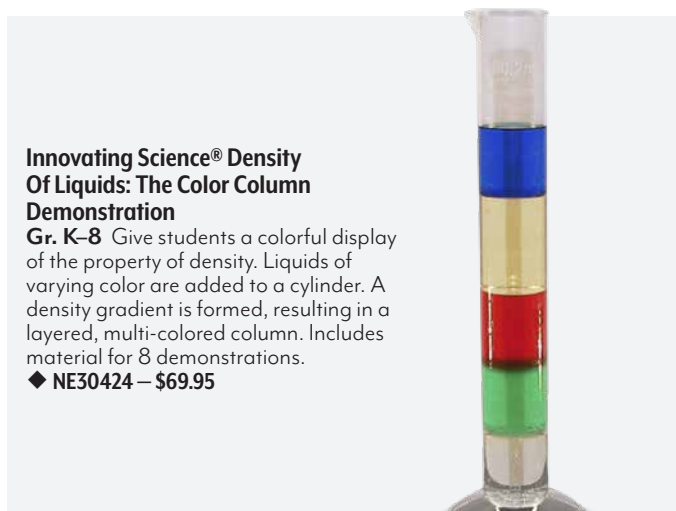

Innovating Science® Density Of Liquids: The Color Column Demonstration

Gr. K–8 Give students a colorful display of the property of density. Liquids of varying color are added to a cylinder. A density gradient is formed, resulting in a layered, multi-colored column. Includes material for 8 demonstrations.
◆ NE30424 – \$69.95

Families of Elements Experiment

Experiment with properties of the halogen family and determine the formulas of their compounds. For 50 students. **CHOKING HAZARD (I)**. Not for under 3 yrs.
SA08240 – \$164.95
No. 110R-RC. Refill (chemicals only). **CHOKING HAZARD (I)**. Not for under 3 yrs.
SA08531 – \$110.00



BEST SELLER



Acid or Base? Individual Student Kit

Gr. 7–12 Use as a take-home science experiment for distance learning. Students will be introduced to acids and bases, then test a dilute acid and dilute base with neutral litmus paper. Next, they'll use the additional pH strips to test common items around their household. Instructions included. Enough materials inside to run experiment twice.
SB53419 – \$17.95



Properties of Acids and Bases Experiment Kit

Seven exercises involving acids and bases include reacting various metals with acids and producing hydrogen in safe quantities, collecting and testing carbon dioxide, performing a neutralization experiment, and more. For 50 students. **CHOKING HAZARD (I)**. Not for under 3 yrs.
◆ SA08229 – \$189.95

**BEST
SELLER**



Periodic Table: Nonmetals, Metals, and Metalloids

Students will examine the physical properties of several elements; test the chemical reactivity of each element; and classify each of the tested elements as either metal, nonmetal, or metalloid. Teacher's manual and student study guide copy-masters included. Enough materials for 15 groups.

SB53056 – \$70.50



Fizz Wizard and Jammin' Jelly Reaction Kit

Make soda pop and make it change colors; make polymer pudding; and learn about chemical solutions, acid-base reactions, indicators, pH, and gels. **CHOKING HAZARD (I)**. Not for under 3 yrs.

SB31105 – \$10.95



Innovating Science® The Hydrogen Fuel Cell Demonstration Kit

Gr. 9–12 Show students how energy can be produced from combining hydrogen and oxygen to form water. Kit contains materials for 5 demonstrations and an NGSS-aligned guide.

NE30425 – \$56.00



Nasco Crystal Growing Kit

Learn about the development of crystals, different types and shapes of crystals, and how they form while growing your own crystals. Aligned to NGSS. For 24 students in groups of 4. **CHOKING HAZARD (I)**. Not for under 3 yrs.

SB47141 – \$138.95

A. pH Measurement/Indicator Kit

Pre-mixed buffers and indicators in spill-proof, contaminant-proof bottles. For 30 students working in teams to perform the experiments individually. **CHOKING HAZARD (I)**. Not for under 3 yrs.

SA08228 – \$153.95

Refill (Chemicals Only). **CHOKING HAZARD (I)**. Not for under 3 yrs.

SA08520 – \$106.95

B. Chemical Equations I

Gr. 7+ Perform 2 single replacement reactions and 2 double replacement reactions. Observed are color change, formation of precipitates, and production of gases. For 28 students working in groups of 4. Experiment can be repeated twice. **CHOKING HAZARD (I)**. Not for under 3 yrs.

SB43452 – \$101.95

C. Simulated Urinalysis Kit

Gr. 7+ Examine simulated urine for factors such as pH, color, and clarity, as well as test for the presence or absence of proteins, glucose, and calcium. For 15 groups of students. **CHOKING HAZARD (I)**. Not for under 3 yrs.

SB47396 – \$75.00

D. Identification of Chemical Reaction Kit

Identify 3 types of chemical reactions: color changes, precipitates, and gas generation. The 7 known solutions are mixed into any of 21 possible combinations and observed. For 50 students. **CHOKING HAZARD (I)**. Not for under 3 yrs.

SA08231 – \$156.95

SA08525 Refill (chemicals only). **CHOKING HAZARD (I)**. Not for under 3 yrs. **— \$105.00**

E. Physical and Chemical Properties of Matter

Perform a series of experiments to determine density, smell, color, melting point, boiling point, and solubility, as well as the chemical properties to identify an unknown solution. For 10 groups.

SB51978 – \$169.95

F. Characteristics of Matter Kit

Gr. 5–9 These 10 experiments explore the properties and states of matter, physical properties of solids and liquids, melting and boiling points, solubility of solids, density, chemical properties, and identification of unknown solutions. Required, but not included: balance, ice, 24 small test tubes, test tube racks, 10 ml graduated cylinders, 6 beakers or clear cups, chemical splash goggles.

For 24 students working in groups of 4. **CHOKING HAZARD (I)**. Not for under 3 yrs. **SB21299 – \$209.95**

Chromatography Paper – 1 in. Wide x 100 yd. Roll

Smooth, paper for general analytical separations, electrophoresis, or chromatography requirements. Provides good resolution and a capillary rise of 24 mm/min. Compares to Whatman No. 1 for filtration.

SBI6079 – \$41.95



Chromatography Paper Strips

Gr. 7+ Pack of 100, 15 x 2 cm. **SB52175 – \$3.75**



CHOKING HAZARD (I) See page 3 for complete Choking Hazard Label Information.

DOT hazardous material **Subject to DOT hazardous material surcharge.**

Flame Tests and Emission Spectroscopy Experiment Kit

By using spray mist bottles to introduce safe water solutions of various salts through a Bunsen flame, tests of metallic ions are observed with a spectroscope. For 50 students. **CHOKING HAZARD (I)**. Not for under 3 yrs.

SA08241 – \$162.25

SA08532 Refill (chemicals only) **— \$68.95**





Food Nutrient Analysis Kit
Provides pure samples of nutrients studied to standardize tests. Indefinite shelf life. Allows 30 students to test and identify 5 classes of nutrients: sugar, starch, lipid, protein, and vitamin C. Simple, safe, and quick tests. **CHOKING HAZARD (I)**. Not for under 3 yrs. **SB08028 — \$153.95**



Storage Code Key
Some chemicals include a color-coded box for proper inventory storage.

- Oxidizer
- Corrosive
- Poison
- Flammable
- Nonhazardous

DOT Classifications

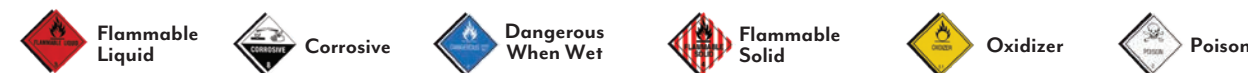

Safety Data Sheets will be supplied with every shipment of chemicals.

CHEMICAL LABELS PROVIDE YOU WITH "RIGHT TO KNOW" INFORMATION

SIGNAL WORD → **Danger**
Highly flammable liquid and vapour. Causes serious eye irritation. May cause drowsiness or dizziness. Repeated exposure may cause skin dryness or cracking.

HAZARD STATEMENTS →

PICTOGRAM →

901 Janesville Ave.
Fort Atkinson, WI 53538
1.800.558.9595
nascoeducation.com

CATALOG NUMBER → **KM00506** **500 mL** → **UNIT OF PACKAGE**

CHEMICAL & GRADE → **Acetone Reagent ACS**
CHEMICAL FORMULA → **CH₃COCH₃** **FW 58.08** → **FORMULA WEIGHT**
CAS NUMBER → **CAS # 67-64-1** **UN1090** → **UN NUMBER**

COLORED STORAGE CODE
Flammable Storage Code Red

LOT NUMBER → **LOT AD - 15000**

PRECAUTIONARY STATEMENTS
Avoid breathing mist/vapours/spray. Keep away from heat/sparks/open flames/hot surfaces. Do not get in eyes, on skin or on clothing. Wear protective gloves/protective clothing/eye protection/face protection. Wash hands thoroughly after handling. **IF ON SKIN (or hair):** Take off immediately all contaminated clothing. Rinse skin with water/shower. **IF IN EYES:** Rinse cautiously with water for several minutes. Remove contact lenses, if present and easy to do. Continue rinsing. If eye irritation persists: Get medical attention. **IF INHALED:** Remove person to fresh air and keep comfortable for breathing. **IF SWALLOWED:** Rinse mouth. Call a **POISON CENTER** or doctor if you feel unwell. In case of fire: Use dry chemical, alcohol foam, carbon dioxide or water spray to extinguish. Store in a well-ventilated place. Keep container tightly closed. Store locked up. Dispose of contents/container to a licensed chemical disposal agency in accordance with local/regional/national regulations.

Keep Out of Reach of Children.
For more information, refer to SDS.



A. Introduction to Ionic Reactions
Introduce students to the concept of ionic reactions through a series of chemical combinations and reactions. For 15 groups. **◆ SB51980 — \$180.00**

B. Science in the Kitchen
Gr. 6+ Incorporates a variety of scientific techniques all based around common kitchen materials. Perform chromatography on commercial food colors, use chemical tests to identify an unknown cooking ingredient, and more. For 15 groups. **SB43601 — \$184.00**



C. OB-Scertainer® Kit (Scientific Method)
Develop a hypothesis about the inner configuration of an OB-Scertainer® by indirect observation, then test hypothesis and make a new one if needed. Reusable. Can be used by 24 students simultaneously. **CHOKING HAZARD (I)**. Not for under 3 yrs. **SA05920 — \$112.95**



D. Enzyme Activity Study Kit
These 5 experiments have students compare an enzyme's role to that of a reacting substance, test the effect of enzyme concentration on rate of reaction, and more. For 50 students. **CHOKING HAZARD (I)**. Not for under 3 yrs. **SA05452 — \$207.95**



E. Enzymes and the Process of Digestion Kit
Gr. 9+ Expose 3 nutrients (carbohydrates, proteins, and lipids) to different digestive enzymes. Compare samples to nutrients to which no enzymes are added. Use chemical tests to determine if the enzymes were effective in digesting the compounds. Enough materials for 15 groups. **◆ SB50722 — \$72.80**



F. Red Cabbage Jiffy Juice
Gr. 5+ Very stable and easy-to-use red cabbage extract powder. A safe, all food grade material with low odor and a long shelf life. Will make several gallons of strong red cabbage juice. **SB39241 — \$10.50**

Purity Grades
Different applications may or may not require guaranteed purity levels of the chemicals being used. As a general rule, the higher the purity of a chemical, the higher the cost will be. For this reason, Nasco Education offers a variety of purities or grades of each chemical depending on the application. Common chemical grades are:

ACS Reagent Grade — Manufactured and guaranteed to the highest specifications as set by ACS (American Chemical Society). These chemicals are necessary for analytical applications requiring the most stringent standards.

Reagent Grade — These chemicals are guaranteed to meet or be below maximum impurity limits as stated. Reagent grade is suitable for use in general analytical testing.

Laboratory (Educational) Grade — The most economical of chemicals, these general, all-purpose chemicals are suitable for use in applications where no specific purity and/or other standards are specifically called for. They are suitable for almost all educational applications.

Biological Stains and Solutions — We have greatly expanded our offerings of biological stains and ready-to-use staining solutions. Every effort has been made to include affordable and practical small package sizes. All dry stains are of certifiable quality. They are for use in the most exacting work in biology, cytology, etc.

Indicators — As with biological stains, we have also expanded the indicators in our chemical list. Small, practical, and affordable package sizes are included. All indicators and indicator solutions are of the highest quality for laboratory use.

▲ See page 3 for complete Choking Hazard Label Information.
◆ DOT hazardous material **◆** Subject to DOT hazardous material surcharge.

Health Notice
The chemicals listed are not sold for consumption, pharmaceutical, or medicinal purposes. They are sold only for research, commercial, and educational use under proper supervision. Only orders on school letterhead, purchase order forms, or phone orders with a school purchase order number will be accepted. Chemicals will be shipped only to the school address. Sorry, we cannot accept orders placed by individuals.

Shipping Containers and Costs
Nasco Education does not charge for cartons, labels, and other packaging materials. The listed price includes all handling and packaging charges that have been established and required by the DOT (Department of Transportation). Materials that require additional shipping charges are marked with a DOT icon.

How We Ship
Nasco Education urges that, to the extent possible, you try to anticipate your chemical needs and combine as many items as possible to reduce shipping charges. With few exceptions, we ship via FedEx.

Hazardous Materials
We have identified all hazardous materials with DOT Classification Symbols.

◆ Subject to DOT hazardous material surcharge.
Nasco Education strictly adheres to the U.S. Department of Transportation regulations regarding products classified as hazardous materials. In following these regulations, you may be assessed a special handling surcharge per carton for these items. Some items may only have a surcharge when ordered in multiples.

A			
Description	Product No.	1 Unit Equals	Unit Price
Alcohols — see individual listings			
Alka-Seltzer ■ tablets	SB07643	Pkg. of 24	\$10.95
Alum — see Aluminum potassium sulfate			
Aluminum ■ Al, foil (household types), 25' roll	SB30673	Roll	\$3.95
Aluminum hydroxide ■ Al(OH) ₃ F.W. 78.00 Grade: reagent Form: powder CAS 21645-51-2 Shelf Life: 36 months	SA09331	500 g	\$44.95
Aluminum potassium sulfate (alum, potassium) ■ AlK(SO ₄) ₂ ·12H ₂ O F.W. 474.38 Grade: laboratory Form: crystals CAS 7784-24-9 Shelf Life: 36 months	SA09334	500 g	\$13.05
Ammonium chloride ■ NH ₄ Cl F.W. 53.49 Grade: ACS reagent Form: granular CAS 12125-02-9 Shelf Life: 12 months	SB16962	100 g	\$5.50
Antacid ■ effervescent tablets (not for human consumption — lab use only) Grade: laboratory Shelf Life: 36 months	SB51063	Pkg. of 24	\$13.00

B			
Description	Product No.	1 Unit Equals	Unit Price
Boiling chips — see Calcium carbonate			
Borax — see Sodium borate			
Bromothymol blue ■ 0.04% con., pH range 6.0 yellow to 7.6 blue Grade: laboratory Shelf Life: 36 months	SA09399	100 ml	\$3.95
Buffer solutions ■ pH accuracy ±0.01 at 25° C, pH 4.00 (colored red) Grade: laboratory Shelf Life: 24 months	SB49247		\$6.95
Burner, alcohol fuel — see Ethyl alcohol			

Storage Code Key
Some chemicals include a color-coded box for proper inventory storage.

■ — Oxidizer ■ — Flammable
 — Corrosive ■ — Nonhazardous
■ — Poison

DOT Classifications

Subject to a Hazardous Material Surcharge.

C			
Description	Product No.	1 Unit Equals	Unit Price
Calcium carbonate ■ CaCO ₃ , lt. ppt. F.W. 100.09 Grade: laboratory Form: powder CAS 1317-65-3 Shelf Life: 36 months	SA09409	100 g	\$6.15
	SA09410	500 g	\$12.25
Calcium chloride ■ CaCl ₂ ·2H ₂ O F.W. 147.02 Grade: reagent Form: powder CAS 10035-04-8 Shelf life: 12 months	SB16978	500 g	\$19.25
Calcium chloride ■ CaCl ₂ , anhydrous F.W. 110.99 Grade: laboratory Form: granular CAS 10043-52-4 Shelf Life: 12 months	SB51085	2.5 kg	\$21.95
Calcium chloride ■ CaCl ₂ anhydrous, 4-8 mesh F.W. 110.99 Grade: laboratory Form: granular CAS 10043-52-4 Shelf Life: 12 months	SA09417	500 g	\$7.95
	SA09418	2 kg	\$19.95
Calcium chloride ■ CaCl ₂ ·2H ₂ O F.W. 147.02 Grade: reagent Form: powder CAS 10035-04-8 Shelf Life: 12 months	SA09416	500 g	\$15.25
	SA07826	2 kg	\$47.50
Chalk — see Calcium carbonate			
Charcoal Pellets, Activated ■ C F.W. 12.01 Grade: laboratory Form: pellets CAS 7440-44-0 Shelf Life: 36 months	SB47148	1 lb.	\$13.95
	SA05525	5 lbs.	\$60.95
Citric acid ■ C ₆ H ₈ O ₇ , anhydrous F.W. 192.13 Grade: laboratory Form: powder CAS 77-92-9 Shelf Life: 12 months	SB01168	500 g	\$14.95
Copper ■ Cu, wire, bare, 16-ga. F.W. 63.55 Grade: laboratory Form: wire CAS 7440-50-8 Shelf Life: 36 months	SB10505	4 oz.	\$8.15
	9711270	1 lb.	\$25.65
Copper ■ Cu, wire, bare, 18-ga. F.W. 63.55 Grade: laboratory Form: wire CAS 7440-50-8 Shelf Life: 36 months	9711269	1 lb.	\$27.35
Copper ■ Cu, wire, bare, 22-ga. F.W. 63.55 Grade: laboratory Form: wire CAS 7440-50-8 Shelf Life: 36 months	SB10508	4 oz.	\$8.15

Safety Data Sheets supplied with every shipment of chemicals from Nasco Education

D			
Description	Product No.	1 Unit Equals	Unit Price
Dehydrating agents — see Calcium chloride			
Dextrose (glucose) ■ C ₆ H ₁₂ O ₆ ·H ₂ O F.W. 198.17 Grad: laboratory Form: powder CAS 5996-10-1 Shelf Life: 36 months	SB07693	500 g	\$17.95
Distilled water ■ H ₂ O CAS 7732-18-5 Shelf Life: indefinite	SB07177	4 liters	\$3.95
E			
Ethanol — see Ethyl alcohol			
Ethyl alcohol ■ (ethanol) 95% denatured Grade: reagent Shelf Life: 36 months	◆ KM00009	3.8 liters	\$40.50
F			
Formaldehyde solution □ HCHO 37% formalin Grade: laboratory NOTE: AN ALLEGED CARCINOGEN. △ CHOKING HAZARD (I). Not for under 3 yrs.	◆ SB01176	4 liters	\$14.95
G			
Glucose — see Dextrose			
Glycerin (glycerol) ■ HOCH ₂ CHOHCH ₂ OH F.W. 92.10 Grade: reagent CAS 56-81-5 Shelf Life: 36 months	SA07847	500 ml	\$16.95
Gram's iodine □ Grade: laboratory Shelf Life: 12 months	SB52746	500 ml	\$16.95
H			
Hydrochloric acid □ HCl 37% concentrated, molarity 12.1 F.W. 36.46 Grade: reagent CAS 7647-01-0 Shelf Life: 24 months	◆ KM00319	500 ml	\$24.50
Hydrochloric acid □ 1.00N Grade: laboratory Shelf Life: 24 months	◆ SB10449	500 ml	\$5.95
Hydrogen peroxide ■ H ₂ O ₂ , 6% solution F.W. 34.02 Grade: laboratory CAS 7722-84-1 Shelf Life: 12 months	SB52800	500 ml	\$7.95
	SB52801	1 liter	\$11.95
Hydrogen peroxide ■ 30%, stabilized Grade: reagent Shelf Life: 12 months	◆ KM00869	100 ml	\$6.05
	◆ KM00870	500 ml	\$14.50
Hydrogen peroxide ■ 3% solution Grade: laboratory Shelf Life: 12 months	SB52742	100 ml	\$3.95
	SB01177	500 ml	\$5.95
Hydrogen peroxide ■ 30%, stabilized Grade: laboratory Shelf Life: 12 months	◆ SB51100	3.8 liters	\$49.95

I			
Description	Product No.	1 Unit Equals	Unit Price
Iodine potassium iodide solution □ Grade: laboratory Shelf Life: 12 months	KM00626	100 ml	\$6.25
	◆ KM00627	500 ml	\$19.95
Isopropyl alcohol ■ 70%, rubbing alcohol Grade: laboratory Shelf Life: 12 months	◆ KM00635	500 ml	\$8.95
Isopropyl alcohol ■ 70% Grade: laboratory Shelf Life: 36 months	◆ SB52803	Case of 2, 500 ml each	\$14.95

△ See page 3 for complete Choking Hazard Label Information.
◆ DOT hazardous material ◆ Subject to DOT hazardous material surcharge.

L			
Description	Product No.	1 Unit Equals	Unit Price
Litmus paper ■ blue, 100 per vial	SB14759(A)	12 Vials	\$17.00
M			
Magnesium ■ Mg, 0.006" x 1/8" F.W. 24.31 Grade: laboratory Form: ribbon CAS 7439-95-4 Shelf Life: 36 months	◆ KM00340	25 g	\$13.95
Marble chips — see Calcium carbonate			
Methylene blue ■ saturated aqueous solution Grade: laboratory Shelf Life: 36 months	SB07740	100 ml	\$9.05
Muriatic acid — see Hydrochloric acid			
N			
Nichrome wire ■ bare, solid, 18-ga. Shelf Life: indefinite	SB10527	4 oz.	\$23.50

Keep your lab clean!
Check out PPE and cleaning supplies on pp. 160–165



Contact Nasco Education if the chemicals you require are not listed.

P			
Description	Product No.	1 Unit Equals	Unit Price
pH Test Paper — see pp. 136-137			
Phenol red 0.02% con. ■ pH range 6.8 yellow to 8.4 red Grade: laboratory Shelf Life: 36 months	SA09655	500 ml	\$5.95
Phenolphthalein ■ 1% ethanol solution Grade: laboratory Shelf Life: 36 months	◆ KM00686	100 ml	\$5.05
Potassium ■ K Lumps F.W. 39.10 Grade: laboratory CAS 7440-09-7 Shelf Life: 36 months	◆ KM01004	10 g	\$134.95
Potassium iodide ■ KI F.W. 166.00 Grade: reagent Form: crystals CAS 7681-11-0 Shelf Life: 12 months	SA09682	100 g	\$43.95
Potassium iodide ■ KI F.W. 166.00 Grade: laboratory Form: crystals CAS 7681-11-0 Shelf Life: 12 months	SA09683	500 g	\$229.95
Potassium iodide ■ KI F.W. 166.00 Grade: laboratory Form: crystals CAS 7681-11-0 Shelf Life: 12 months	SB07873	100 g	\$54.95
PTC paper strips ■ 100 per vial	SA07854(A)	12 vials	\$30.00
S			
Sal soda — see Sodium carbonate			
Silver nitrate ■ AgNO ₃ F.W. 169.87 Grade: reagent Form: crystals CAS 7761-88-8 Shelf Life: 24 months	◆ KM00254	25 g	\$92.95
	◆ KM00712	100 g	\$254.95
Sodium ■ Na, metal, purified F.W. 22.99 Grade: laboratory Form: lumps CAS 7440-23-5 Shelf Life: 12 months	◆ KM01078	100 g	\$92.95
Sodium bicarbonate (baking soda) ■ NaHCO ₃ F.W. 84.01 Grade: laboratory Form: powder CAS 144-55-8 Shelf Life: 36 months	SB07881	500 g	\$8.05
	SB51107	2.5 kg	\$23.50
Sodium borate (borax) ■ Na ₂ B ₄ O ₇ ·10H ₂ O F.W. 381.37 Grade: laboratory Form: powder CAS 1303-96-4 Shelf Life: 12 months	SB07883	500 g	\$6.05
Sodium carbonate (soda ash) ■ Na ₂ CO ₃ , anhydrous F.W. 105.99 Grade: ACS reagent Form: powder CAS 497-19-8 Shelf Life: 36 months	SA07857	500 g	\$13.95
Sodium chloride ■ (rock salt) NaCl, coarse F.W. 58.45 Grade: laboratory Form: large crystals CAS 7647-14-5 Shelf Life: 60 months	SA09739	500 g	\$5.95
Sodium hydrogen carbonate — see Sodium bicarbonate			

Description	Product No.	1 Unit Equals	Unit Price
Sodium iodide ■ NaI F.W. 149.89 Grade: reagent Form: crystals CAS 7681-82-5 Shelf Life: 12 months	SA09747	100 g	\$44.95
Starch ■ C ₆ H ₁₀ O ₅) _n , corn- F.W. 162.15 Grade: laboratory Form: powder CAS 9005-25-8 Shelf Life: 36 months	SA07834	500 g	\$14.25
T			
Tes-Tape ■ (glucose test strips, for urine sugar determination) sufficient for 100 tests Grade: reagent	SB09754	100 Strips	\$15.95
V			
Vegetable oil ■ soybean Grade: laboratory Shelf Life: 36 months	SA09801	500 ml	\$13.95
W			
Water — see Distilled water			
Wood splints ■ 500 per bundle	SA08889	Bundle	\$5.95
Z			
Zinc chloride □ ZnCl ₂ F.W. 136.29 Grade: laboratory Form: granular CAS 7646-85-7 Shelf Life: 36 months	◆ SB07900	500 g	\$32.95







*Safety Data Sheets supplied with every
shipment of chemicals from Nasco Education*

Storage Code Key

Some chemicals include a color-coded box for proper inventory storage.

- — Oxidizer
- — Flammable
- — Corrosive
- — Nonhazardous
- — Poison

DOT Classifications



 Flammable Liquid	 Corrosive	 Dangerous When Wet
 Flammable Solid	 Oxidizer	 Poison



Subject to a Hazardous Material Surcharge.



**Contact Nasco Education if the
chemicals you require are not listed.**

**Modular Stacking Cabinets
(Acids, Flammables, Combination) — SciMatCo**

Can be used as stand-alone unit or modular stacking unit. All cabinets are constructed of 1" multi-ply plywood, have 2 locks, and feature a 2" liquid-tight spill retention floor trough. Finished with a tough, durable coating including layers of chemical-resistant epoxy. 47"W x 18"D x 18"H. Meets applicable OSHA and NFPA standards. Flammables cabinets are UL listed.



Acid/Corrosive. All-wood cabinet with polypropylene lined floor and 22 x 2.5-liter capacity.  
Z15887 — \$1,240.00

Flammables with Self-Closing Door. Designed for stacking or stand-alone. Meets Uniform Fire Code. Capacity: 20 x 1 gallon.  
Z50260 — \$1,315.00

Combination Acid/Flammables with Self-Closing Door. Meets Uniform Fire Code. Internal metal lock on flammables side (capacity: 10 x 1 gallon). Plastic hasp and padlock on corrosive side (capacity: 10 x 2.5 liters).  
Z50261 — \$1,550.00





SciMatCo Safety Flammables Floor Cabinet with One Shelf

This wooden storage cabinet is designed to fit most school science departments, and is in full compliance with OSHA and NFPA requirements. Constructed of 1 in. thick, high-density plywood, finished with yellow epoxy paint inside and out. Corrosion-resistant piano-type hinges on doors. Printed with "FLAMMABLE — KEEP FIRE AWAY." 23 7/8" W x 23 7/8" D x 36 5/8" H. 30 x 1 gallon capacity.  
Z50257 — \$1,125.00



SciMatCo Bench Top Safety Cabinet - Corrosive Cabinet

High-quality, low-cost, wooden storage cabinet is designed to fit most school science departments and is in full compliance with OSHA and NFPA requirements. Printed with CORROSIVE. Includes external padlock with two keys. Constructed of 1 in. multi-ply plywood and finished with multiple coats of chemical resistant paint. Wood construction eliminates rust or corrosion. Cabinet measures 21 1/4" H x 16 3/4" W x 15 3/4" D.  
Z15886 — \$945.00

All acid and safety cabinets sold by Nasco Education are built in full compliance with all acceptable OSHA and NFPA requirements. All flammables storage cabinets are UL listed. Before purchasing any chemical storage cabinet, familiarize yourself with all local and state codes from the appropriate agencies having jurisdiction. Self-closing doors may be required for flammables cabinets.

LAB SUPPLIES

Precise, accurate testing and experimentation in your lab requires the proper supplies.

From beakers to flasks, gloves to goggles, scales to balances, and protective gear to lab equipment, get all the essentials to measure, store, and contain materials while keeping students safe.

- Glassware/Plasticware **118-127**
- Drying Racks **128**
- Accessories & Ring Stands **129-131**
- Chemistry Sets **132**
- Data Loggers, Test Papers & Meters **133-135**
- Lab Equipment **136-141**
- Balances & Scales **142-150**
- Rulers & Measurement Tools **151-153**
- Calculators, Timers & Thermometers **154-159**
- Protective Equipment & Health/Safety **160-165**
- Kit Components **166-167**



Nasco Glass Beaker Set
Set of 5 includes 1 borosilicate beaker each of 50, 100, 250, 600, and 1,000 ml.
SB45964 – \$15.75



Corning® PYREX® Low Form Beaker Set
Graduated with double scales. Pack of 5 contains 1 each of 50, 100, 250, 600, and 1,000 ml.
SB46695 – \$36.95

PYREX® VISTA™ Low-Form Griffin Beakers
ASTM E960 specifications. Blue graduations and novel marking spot.

Product No.	Capacity ml	Graduation Interval ml	Each
SB46185	50	10	\$5.95
SB46186	100	10	\$4.75
SB46187	150	10	\$4.95
SB46188	250	25	\$5.50
SB46189	400	25	\$5.50
SB46190	600	50	\$5.95
SB46191	1,000	50	\$11.95



Corning® PYREX® Griffin Beakers – Low Form
Uniform wall thickness. Optimum balance between thermal shock resistance and mechanical strength. Type I Class A per ASTM E438, E960 specifications. The 250–4,000 ml beakers have double-graduated metric scale.

Product No.	Capacity ml	Graduation Range ml	Graduation Interval ml	Each
SB42606	50	10-40	10	\$4.95
SB42607	100	20-80	10	\$5.25
SB42608	150	20-140	10	\$5.50
SB42609	250	25-200	25	\$5.95
SB42610	400	25-325	25	\$6.25
SB42611	600	50-500	50	\$6.95
SB42612	1,000	50-1,000	50	\$12.55
SB42613	2,000	200-1,800	100	\$25.95



Nasco Low-Form Griffin Beakers
Low-expansion borosilicate with properties equivalent to ASTM E960 Type I specifications. Double graduations with a limit error of ±5% of full capacity.

Product No.	Capacity ml	Graduation Interval ml	Each
SBI7976	50	10	\$2.05
SBI7977	100	10	\$2.50
SBI7978	150	10	\$2.60
SBI7979	250	25	\$2.75
SBI7980	400	25	\$3.00
SBI7981	600	50	\$4.00
SBI7983	1,000	50	\$6.25
SBI7984	2,000	200	\$9.50



A. Nesting Graduated Beaker Set
Unbreakable plastic. Blue calibrations. Set of 5 includes 50, 100, 250, 500, and 1,000 ml.
TB23262 – \$11.95



B. Plastic Beakers
Molded in polypropylene. Autoclavable. Good chemical resistance. Raised graduations.
Set of 6. 1 each of 6 plastic beakers below.
SB49209 – \$55.00

250 ml	SB37392 – \$6.95
SB37390 – \$3.95	2,000 ml
500 ml	SB37393 – \$9.95
SB37391 – \$4.25	5,000 ml
1,000 ml	SB37394 – \$18.95

C. Polypropylene Advanced Beaker Set
Blue-screened graduations are legible, abrasion resistant, and withstand many chemicals. Suitable for intermediate and advanced applications. Nesting. Set of 5 includes 50, 100, 250, 600, and 1,000 ml.
SA05352 – \$32.95



D. Plastic Nesting Beakers
Resistant to most bases, acids, and other solvents. Can be autoclaved up to 100° C. Raised numerical graduation scale. Includes 1 each of 30, 50, 100, 150, 250, 400, 600, and 1,000 ml.
SB51120 – \$14.50



E. Graduated Plastic Beaker Set
A nested set of beakers including 50, 100, 250, 500, and 1,000 ml. Heat resistant up to 120° C and autoclavable.
SBI9214 – \$15.50



F. Scienceware® Write-On™ Label Tape
Peels off without leaving sticky residue. Use pencil, ballpoint pen, or solvent ink marker. Resists moisture and most solvents. Withstands maximum temperature of 315° F for 30 minutes or 176° F for 24 hours. Can be used down to -112° F. 40 yds. 3/4". Includes one each of white, red, yellow, green, blue, and orange.
SB40949 – \$101.00

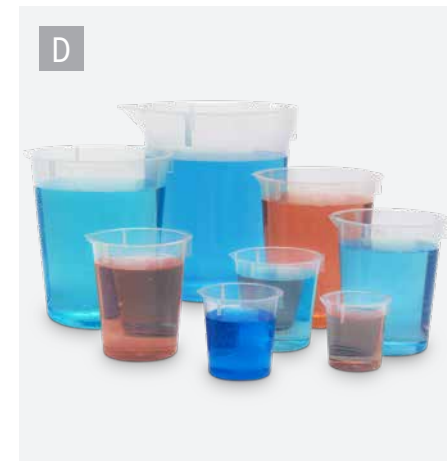

Polypropylene Graduated Beakers

Straight-sided and translucent. Heat-resistant up to 135° C. Square ratio design with vertical lip. Graduations and indications of material and maximum heat resistance are printed in blue. Autoclavable at 250° F (121° C).



Product No.	Capacity ml	Subdivisions ml	Height mm	Each	Qty.	Each
SBI9215	50	5	51	\$3.50	12+	\$3.39
SBI9216	100	10	62	\$4.75	12+	\$4.62
SBI9217	250	25	82	\$7.25	12+	\$7.06
SB24114	400	50	95	\$7.25	12+	\$6.81
SBI9218	500	50	102	\$9.25	12+	\$8.83
SB24115	600	50	107	\$9.50	12+	\$8.73
SBI9219	1,000	100	126	\$10.50	12+	\$10.08

MIX, MEASURE, DISCOVER
with high-quality flasks

BEST SELLER

Narrow-Mouth Erlenmeyer Flask
Borosilicate glass. Tooled top finish, capacity scale, thick walls, long tapered outside contour. Strain point 520° C.

Set of 5. Includes 1 each of 50, 125, 250, 500, and 1,000 ml flasks below.
SB44510 — \$29.95

Product No.	Capacity ml	Rubber Stopper Fit	Each	Qty.	Each
SB17972	50	2	\$3.00	12+	\$2.75
SB17973	100	3	\$3.40	12+	\$3.15
SB26515	125	5	\$5.20	12+	\$4.82
SB17974	250	6	\$5.75	12+	\$5.24
SB17975	500	7	\$7.95	6+	\$7.27
SB26518	1,000	9	\$14.50	6+	\$13.40



Hot Hand Protector

Silicone-rubber molded hand protector with studded gripping surface. Withstands temperatures up to 500° F (260° C). Retains flexibility down to -70° F (-57° C). Thumb and finger end pockets fit any size hand. 3 7/8" x 7 7/8".

SB01889 — \$12.95



Biohazard Autoclave Gloves

Soft, pliant, all-cotton terry cloth gloves for handling hot objects out of the autoclave or oven. Heat resistant up to 450° F (232° C). No asbestos. Protects wrist and forearm. 13"L. NOTE: Gloves are not waterproof and cannot be used to handle dry ice.

SB39277 — \$47.95

KIMAX® Narrow-Mouth Erlenmeyer Flasks
Reinforced beaded top and capacity scale. Borosilicate glass.

Product No.	Capacity ml	Rubber Stopper Fit	Each	Qty.	Each
SB02764	125	5	\$7.50	12+	\$6.99
SB02765	250	6	\$8.95	12+	\$8.37
SB02766	500	7	\$11.50	6+	\$10.80

PYREX® Narrow-Mouth Erlenmeyer Flasks
Student grade. Economical. Uniform wall thickness gives proper balance between mechanical strength and thermal shock resistance. Approximate graduations in enamel.

Product No.	Capacity ml	Each
SB42601	125	\$5.95
SB42602	250	\$6.95

PYREX® Erlenmeyer Flask Set. Includes 1 each of 5 sizes: 50, 125, 250, 500, and 1,000 ml.
SB46694 — \$51.95



Superior-Grade Cylinders — Plastic

A. Dynalon PMP® Graduated Cylinders

Single scale. Crystal clear. Shatterproof. Raised graduations. Wide base. Superior chemical resistance, heat resistance to 350° F (177° C); no meniscus.

Product No.	Capacity ml	Each	Qty.	Each
SB16307	10 x 0.2	\$4.15	20+	\$3.85
SB16308	25 x 0.5	\$5.15	20+	\$4.68
SB16309	50 x 1	\$6.15	20+	\$5.65
SB16310	100 x 1	\$7.15	10+	\$6.53
SB16311	250 x 2	\$12.15	5+	\$11.09
SB16312	500 x 5	\$19.00	5+	\$17.47
SB16313	1,000 x 10	\$29.00	4+	\$26.58

B. Plastic Graduated Cylinders

Tough, transparent plastic. Accurately calibrated on yellow background. Cannot be used for concentrated acids, bases, or stronger organic solvents. Plastic surface does not create meniscus. Large, stable base.

Product No.	Capacity ml	Each	Qty.	Each
SA02306	50	\$2.25	12+	\$1.85
SA02307	100	\$2.55	12+	\$2.35

C. Polypropylene Graduated Cylinders, Single Scale — Class B

No meniscus. Raised graduations. Wide base. Excellent chemical resistance. Autoclavable. TC/TD 20° C. Temperature range: -4° to 275° F (-20° to 135° C). NOTE: Not recommended to keep 500 ml cylinders and larger at maximum temp. for long periods of time, as plastic can get soft and bend.

Product No.	Capacity ml	Each	Qty.	Each
SB08686	10 x 0.2	\$2.25	20+	\$2.03
SB07277	25 x 0.5	\$2.55	20+	\$2.30
S00925	50 x 1	\$2.95	20+	\$2.65
S00926	100 x 1	\$4.50	10+	\$4.06
S00927	250 x 2	\$5.55	5+	\$5.00
S08307	500 x 5	\$7.50	5+	\$6.75
S08308	1,000 x 10	\$13.95	4+	\$12.56

Superior-Grade Graduated — Glass

D. Corning® PYREX® Graduated TC Cylinders, Single Metric Scale — Class A
Calibrated "to contain" (TC). White enamel graduations. Bumper guards for all capacities except 10 ml. Funnel top for 10 ml; pour-out top for all other sizes.

Product No.	Capacity ml	Each	Qty.	Each
SB46672	10	\$22.95	12+	\$19.20
SB47371	50	\$28.95	12+	\$25.87
SB47372	100	\$31.95	12+	\$27.92

Superior-Grade Graduated — Glass

E. Class B, Cylinders, Single Metric Scale, with Bumper Kimble KIMAX®
Superior grade.

Product No.	Capacity ml	Each	Qty.	Each
SB08192	25 x 0.5	\$26.95	4+	\$24.26
SB08193	50 x 1	\$30.95	4+	\$27.86
SB08194	100 x 1	\$35.95	4+	\$31.46

F. Nasco Graduated Cylinder, Double Metric Scale with Bumper

Superior-grade glass cylinder. Double metric scale. Calibrated to contain permanent graduations. Complies with Fed Spec. NNN-C-940 for user-graded cylinders tolerance limitations. Bumper guard prevents breakage and roll.

Product No.	Capacity ml	Each	Qty.	Each
NE30362	10 x 0.1	\$8.95	12+	\$8.06
NE30363	25 x 0.2	\$11.95	12+	\$10.76
NE30364	50 x 0.5	\$12.95	6+	\$11.66
NE30365	100 x 1	\$13.95	6+	\$12.56

Student-Grade Graduated Cylinders — Glass

G. Economy-Grade Cylinders, Single Metric Scale, with Bumper Kimble KIMAX®

Student-grade, plastic base. *SB08197 does not come with bumper.

Product No.	Capacity ml	Each	Qty.	Each
*SB08197	10 x 0.2	\$9.95	6+	\$9.40
SB08198	25 x 0.5	\$11.95	6+	\$11.25
SB08199	50 x 1	\$11.95	—	—
SB08200	100 x 1	\$14.95	6+	\$14.18

H. Student-Grade Cylinder, Graduated Double Metric Scale, with Bumper

Economical glass cylinder with plastic hexagonal base and bumper. Calibrated "to contain." Plastic parts easily removed.

Product No.	Capacity ml	Each	Qty.	Each
SB17991	10 x 0.2	\$5.55	6+	\$5.05
SB17992	25 x 0.2	\$7.95	6+	\$7.28
SB17993	50 x 1	\$9.15	6+	\$8.54
SB17994	100 x 1	\$11.05	6+	\$10.26

We can create custom kits for your classroom's specific needs! Find out more at nascoeducation.com/custom-kits.

Plastic Labware Set

All items except wash bottles are autoclavable. 26 labware items in addition to 12 plastic tubes.

Contains:

- Beaker, 50 ml
- Beaker, 100 ml
- Beaker, 250 ml
- Beaker, 500 ml
- Beaker, 1,000 ml
- 3 Erlenmeyer flasks, wide mouth w/cap, 250 ml
- Graduated cylinder, 10 ml
- Graduated cylinder, 25 ml
- Graduated cylinder, 50 ml
- Graduated cylinder, 100 ml
- Graduated cylinder, 250 ml
- Graduated cylinder, 500 ml
- Graduated cylinder, 1,000 ml
- 6 storage bottles, square, wide mouth, 500 ml
- Test tube rack with 12 tubes
- 4 wash bottles, unitary, 500 ml

SB52575 – \$82.50



Polypropylene Graduated Cylinders

Set of 7 polypropylene cylinders in calibrations of 10, 25, 50, 100, 250, 500, and 1,000 ml. Autoclavable. **TB20546 – \$23.95**



Wide Mouth Specimen Jars

Clear, flint glass jars feature straight sides and threaded necks. Polypropylene F217 and PTFE lined caps are an economical alternative to Thermoset and Phenolic PTFE lined caps.

Product No.	Capacity	Case Qty.	Case
SB10990	8 oz. (237 ml)	24	\$45.50
SB10994	32 oz. (946 ml)	12	\$56.95



Polypropylene Graduated Cylinders

Distinct graduations for precise volume measurements. Extra-wide hexagon bases and easy-pour spouts. Set of 6: 25, 50, 100, 250, 500, and 1,000 ml. **SA05354 – \$52.95**



Polypropylene Squat Form Cylinders

More stable than traditional glass or plastic cylinders. Graduations are molded and printed in blue. Self-draining base allows waste-water to drain when inverted in dishwasher.

Product No.	Capacity ml	Each
SB47462	100	\$19.50
SB47463	250	\$25.95



Test Tubes for Kids

Gr. 1+ Each safe, plastic test tube holds 28 cc. Includes 12 test tubes with screw-on caps. **ELI2247 – \$14.95**



BEST SELLER

Nasco Test Tube Rack with 15 Safe Tubes

Non-slip rack and 15 safe, unbreakable test tubes with screw lids (SB33231, below). **SB42164 – \$25.00**

Safe Test Tubes. Large, clear plastic test tubes are basically indestructible. Threaded cap prevents spills. Will withstand freezing temperatures or temperatures up to 200° F (will not withstand heat from a flame). Set of 15 tubes and caps with activity guide. Tubes are 6" L, 7/8" dia., and approximately 50 ml (1.75 oz.) capacity. **SB33231 – \$19.50**

Nasco Safe Test Tube Rack. Plastic holder holds up to 5 Safe Test Tubes. **SB45376 – \$12.00**



Almost indestructible! Spill-proof tubes withstand hot and cold temps



Rubber Stopper Assortment

Most cost-effective way to purchase rubber stoppers. Each pack has a selection of solid, one-hole or two-hole stoppers. Size 1–6½. 1 lb. **SB16726 – \$11.95**

Cork Assortment

Bag of 100 corks with nearly equal amounts of each size 2–8. **CHOKING HAZARD (I).** Not for under 3 yrs. **SB10877 – \$20.75**



SB46688

Kimble KIMAX® K6-33 Glass Test Tubes

With sturdy lip and marking spot of fused-on white enamel. Made of tubing with correct wall thickness.

Product No.	Dia./L mm	Cap. ml	Per Doz.	Case Qty.	Case
SA04533	13 x 100	10	\$11.50	6+ doz.	\$10.82
SA04534	15 x 125	16	\$13.50	6+ doz.	\$12.15
SA05086	20 x 150	36	\$18.75	6+ doz.	\$16.88
SA04537	25 x 150	55	\$28.95	6+ doz.	\$26.06
SB33965	25 x 200	75	\$35.95	2+ doz.	\$32.36



Corning® PYREX® Vista™ Test Tubes

Well annealed, resistant to heat, and chemically stable. Blue marking spot. Fire-polished beaded rims. Cylindrical shape. Round bottom.

Product No.	Dia./L mm	Cap. ml	Pack of 10	Case Qty.	Case
SB46682	13 x 100	9	\$6.50	5+	\$5.85
SB46685	15 x 125	14	\$7.50	5+	\$6.75
SB46688	18 x 150	27	\$8.95	5+	\$8.06
SB46691	20 x 150	34	\$10.95	5+	\$9.85

Test Tube Brushes

Multi-fan tip white bristles in twisted wire.

Product No.	Dia.	Bristle Length	Overall Length	Pkg. of 12
SB16143	7/16"	2"	6"	\$10.50
SB16144	3/4"	3"	8"	\$14.00
SB16145	1 1/8"	3"	9"	\$8.95

Cylinder and Bottle Brush

Black nylon bristle brush with radial end. Brush is 5" L, 2" dia. Overall length: 13". **SB08102 – \$2.95 12+ \$2.57**

Beaker, Jar, and Cylinder Brush

Black bristle brush with tufted end on wooden handle. Brush is 6" L, 3/4" dia. Overall length: 16". **SB08103 – \$5.95**



Chemplate®

Eliminates the need for glassware and provides a semi-micro environment. Use as a rack of numbered (1–12) test tubes, a gas generator, a reservoir for water, and more. Pack of 10. **SB19151 – \$24.95**

Well Plate

Clear polystyrene plate has 24 wells (5/8" D) with alpha-numeric markings. 5" L x 3/4" W x 7/8" H. Individually wrapped in plastic bag and nonsterile. Includes lid. **SB47053 – \$4.95**

Porcelain Spot Plates

Use for observing chemical reactions. Economically priced. **6-Cavity, 3/2" x 2/4" x 1/2". 12-Cavity, 4/2" x 3/2" x 9/16". SB40727 – \$2.50 SB40728 – \$5.95**

NEW

Make it easy for students to identify chemicals in your lab

United Scientific UniSafe™ Vented Wash Bottles

Made from industrial-grade low-density polyethylene with polypropylene stem closure and venting assembly. Pre-printed with the chemical name and formula, NFPA diamond, health hazards, and CAS number. Compliant with GHS and OSHA requirements. Pack of six 500 mL (16 oz.) bottles.

- NE30536 Acetone — \$37.95
- NE30537 Ethanol — \$37.95
- NE30538 Distilled Water — \$37.95
- NE30539 Isopropanol — \$37.95
- NE30540 Sodium Hypochlorite — \$37.95
- NE30541 Water — \$37.95
- NE30542 Hand Soap — \$37.98
- NE30543 Deionized Water — \$37.95



LDPE Wash Bottles

Screw closures and stems are made of polypropylene. Through-the-top wash bottle with closure and stem molded in 1 piece for leakproof service. Flexible tubing. Tips dispense uniform stream and can be cut back.

Product No.	Capacity ml	Each
SB53265	250	\$4.95
SB53266	500	\$6.25



Barnes Dropping Bottle

30 ml with rubber bulb forming tight stopper. Glass.

SB01827 — \$2.00



Bottle with Dropper

½ oz. French square flint bottles feature 20/400 bottle cap with dropper. Pack of 12.

SB51111 — \$22.25



Amber Dropping Bottles

Amber-colored glass. Rubber bulbs and pipettes. 1-oz. capacity. Neck size: 18/400. Pack of 12.

SB13996 — \$16.95



LDPE Drop-Dispensing Bottles

20 mm closure. Tethered spout caps snap securely in place and won't break away when bottles are squeezed. Low-density polyethylene. Chemically compatible with most acids, bases, and alcohols. 30 ml capacity.

SB51259 — \$4.95



Geissler Burettes, Straight Glass Stopcock

For all sizes. 2 mm approximate dia. of hole through plug. 0.10 ml subdivisions. Nonstick stopcock grease is recommended. 50 ml capacity. 28½" L.

SA08635 — \$33.50



Glass Burette

Borosilicate glass 50 ml burette. Individually calibrated. White enamel graduations. Graduation interval: 0.10 ml. General-purpose screw-thread stopcocks with PTFE keys provide excellent flow control and Fluon/glass seals that prevent leakage.

SB39109 — \$17.95



Pipette — Glass

Live elastin latex-free nipple, high-luster selected glass. 2 ml capacity. Pack of 12.

SA01161 — \$5.25

Pipette — Plastic

Latex-free rubber nipple with plastic tube. 2 ml capacity. Pack of 12.

SB14002 — \$3.95



Glass Pipettes, Reusable

Heavy-wall borosilicate accurate bore glass tubing. Precision-formed jets and bevel ground ends resist chipping. Graduation marks are resistant to normal laboratory agents and repeated washing. 0.1 ml graduations. Pipettes can be autoclaved. 10 ml.

SB39135 — \$3.35



Two-Valve Natural Rubber Pipette Filler

Eliminates the need for mouth pipetting. 100% natural rubber. Two operating points for fluid intake and draining. Easy to clean. Colors may vary.

SB43861 — \$13.95

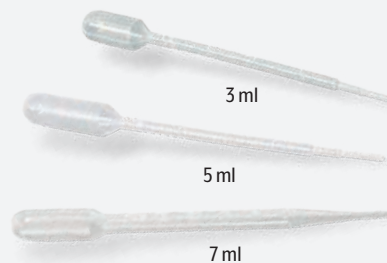

Transfer Pipettes

Nontoxic LDPE. Excellent transparency with uniform wall thickness and precise graduations, ensuring consistent results. Nonsterile.

3 ml. Stem graduations: 0.25 ml. Length: 138 mm, fine-tip. SB50474 Pack of 100 — \$6.00 SB50477 Pack of 500 — \$27.00

5 ml. Stem graduations: 0.25 ml. Length: 160 mm, fine-tip. SB50475 Pack of 100 — \$7.25 SB50478 Pack of 500 — \$33.00

7 ml. Stem graduations: 0.50 ml. Length: 160 mm. SB50476 Pack of 100 — \$7.75 SB50479 Pack of 500 — \$35.00



Fast Release Pipette Pump™ II

Safe with many corrosive or toxic liquids. Holds glass or plastic pipettes easily and securely. Rotate knurled wheel forward or backward for precise filling or emptying or engage the rapid release valve for quick dispensing.

SB37722 Green. Pipettes up to 10 ml. — \$26.95
SB48904 Red. Pipettes up to 25 ml. — \$39.95





Porcelain Mortar and Pestle
100 mm dia. mortar with pouring lip is glazed on outside with natural rough surface inside. Oversized 90 mm pestle is glazed to grinding surface. 130 ml capacity.
SBI7995 – \$8.95

Evaporating Dishes
Rounded bottom and pouring lip. Glazed inside and out, except for rim. Excellent resistance to thermal shock.

Product No.	Dia. mm	Height mm	Capacity ml	Each
SBI7997	70	30	50	\$3.25
SBI7998	80	34	75	\$3.50
SBI7999	90	40	120	\$4.95



Crucibles
Glazed porcelain crucibles can withstand temperatures up to 1,922° F (1,050° C) without cracking, exploding, or deforming. Comes with base and cover.

Product No.	Form	Capacity ml	Size	Each
SB47674	High	15	1¼"H x 1½" dia.	\$3.05
SB47672	High	30	1¾"H x 1½" dia.	\$3.50
SB47677	Low	30	1¼"H x 2" dia.	\$3.75



Wood Splints
Approximately 4 x 140 x 1 mm. Bundle of 500.
SA08889 – \$5.95



Nonsterile Cotton Tips
6" wood stick. Bag of 100.
SB08678 – \$1.95 10+ \$1.67

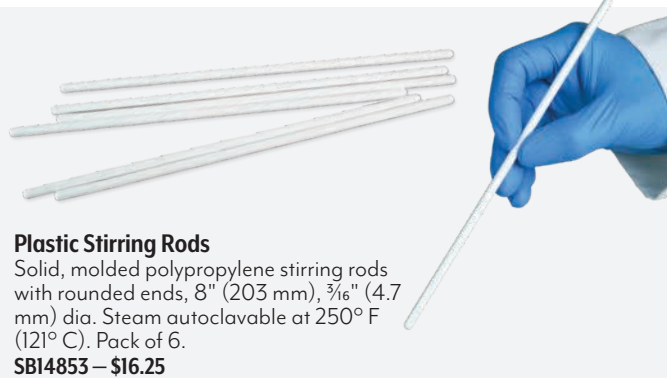

Plastic Stirring Rods
Solid, molded polypropylene stirring rods with rounded ends, 8" (203 mm), 3/16" (4.7 mm) dia. Steam autoclavable at 250° F (121° C). Pack of 6.
SBI4853 – \$16.25



Glass Stirring Rods
Well-annealed with both ends fire polished. Packs of 12.

Product No.	Dia.	Length	Per Pkg.
SBI5199	¼" (5 mm)	8" (20.3 cm)	\$5.15
SBI5200	¼" (5 mm)	10" (25.4 cm)	\$7.25



Parafilm M®
All-purpose lab film is a versatile, moisture-resistant, flexible thermoplastic for a wide variety of applications.
SB39418 2" x 250' – \$40.95
SB39419 4" x 125' – \$34.95

Build your wish list and email it at nascoeducation.com



Plastic Petri Dishes
Sterile plastic polystyrene. 100 mm dia. x 15 mm D. Pack of 10.
SB46631 – \$1.95

BEST SELLER



Petri Dish - Pack of 20
Round, disposable, sterile polystyrene. Flat bottom affords maximum area for observation of growth. 90 mm dia. Approximately 15 mm H. Pack of 20.
SA00371 – \$8.25



Filtering Kit
500 ml filtering flask, 90 mm porcelain Buchner funnel, vacuum hand pump with gauge, pack of 100 filter paper (90 mm), rubber stopper with hole to accept Buchner funnel and tubing, and storage box.
SB42284 – \$63.95

Petri Dishes
Disposable, stackable, and sterile.

100 mm Dia. Divided.
15 mm D dishes divided into 2 sections. Pack of 20.
SB45991 – \$4.50

150 mm Dia. 15 mm D. Pack of 10.
SB45992 – \$26.95

100 mm Dia. with Cover. Pack of 10.
SB51221 – \$36.00

Filter Paper – Qualitative, Medium-Retention
Compares to Whatman No. 1 for filtration. For routine laboratory work and student use. Medium retention of 6 μm. Flow rate of 60 ml/min. Pack of 100.

Product No.	Diameter cm	Pkg.
SB16074	7.0	\$5.50
SB15188	12.5	\$7.95

BEST SELLER

Funnel Set
Set of 5 plastic funnels are stackable, may be boiled, and are dishwasher safe. Includes 1 of each size below.
SB33240 – \$12.00

SB51684 2 oz. – \$1.30
SB51685 4 oz. – \$1.55
SB51686 8 oz. – \$2.55
SB51687 16 oz. – \$3.25
SB51688 32 oz. – \$4.75

Powder Funnel
Good quality polyethylene powder 100 mm funnel for general lab use.
SB39202 – \$2.45

See p. 131 for ring stands

Glass Separatory Funnel
Squibb-style dropping funnel made of heavy-duty borosilicate glass with glass stopcock. With 19/26 size socket with an interchangeable plastic stopper. 250 ml.
SB45476 – \$24.65





A. Draining and Drying Rack

Can be used standing up, lying down, or mounted on a wall. Galvanized metal drain pan keeps liquid off countertop. Vinyl-coated, heavy-gauge steel wire cushions glassware to avoid breaks, chips, and rusting. Capacity: 90 pieces of glassware on 72, 3" pins and 18, 5" pins. 18½" x 7⅞" x 19".
SB23813 — \$145.00

B. Drying/Draining Rack

Self-standing rack can also be mounted to a wall. Holds up to 55 pieces on fifty 4" pins, two 4⅜" pins, and three 5" pins, all rubber tipped. Rack: 14" x 5½" x 26". Removable heavy acrylic drain pan: 13" x 5½" x ¾". For lab use only; not for use by students age 12 and under.
SB45747 — \$61.00



C. Petri Dish Holder

Used to sterilize, refrigerate, or incubate culture dishes. Soft black vinyl coating. Capacity: 18 dishes, 100 x 10 mm; 12 dishes, 100 x 15 mm. 9⅞" x 4⅜" x 7⅞".
SB28540 — \$43.95

D. United Scientific Test Tube Racks

Gr. 5+ These heavy-wire racks will help store tubes while students are working on or collecting different solutions at once. Durable epoxy coating and with multiple places to hold tubes in multiple sizes. Autoclavable.
NE30291 36 Places for 16–20 mm Tubes — **\$23.75**
NE30292 36 Places for 10–13 mm Tubes — **\$18.00**
NE30293 24 Places for 13–16 mm Tubes — **\$17.75**
NE30294 20 Places for 16–20 mm Tubes — **\$17.25**

E. Hardwood Drying Rack

For storing, drying, or dispensing test tubes and 25 ml graduates. 50 hardwood pegs secured to hardwood base 13" x 7¾" x 1".
SB08484 — \$30.00

F. Plastic Test Tube Rack

High-impact plastic rack holds 12 test tubes up to 20 mm in dia. Easy to assemble and chemical resistant. 9" x 2¾" x 5".
SB33666 — \$5.50

G. 20 mm Test Tube and Drying Rack

Holds 12 test tubes up to 20 mm dia. Two shelves. Drying pins. Wood.
SB30117 — \$10.75

H. 24 mm Test Tube Rack

Double row supports hold up to 12 test tubes each. Made of fine oil-finished hardwood. 7½" x 2½" x 5⅝". No drying pins included.
SB10559 — \$12.50

I. Test Tube Rack

Polypropylene, autoclavable in-line test tube rack with 6 holes (25 mm dia.) in top plate with corresponding hemispherical wells in base. Six vertical drying pins. Snap-in assembly. 9½" x 3" x 3⅝".
SB01890 — \$9.95

J. Test Tube Rack

Made of hardwood. Supports 12 test tubes upright or inverted. Has 10 holes for test tubes up to 20 mm dia., 2 holes for 25 mm test tubes, and 12 drying pins. 16½" x 3" x 3¾".
SB01635 — \$5.95



Steel Forceps

Nickel-plated to prevent rust. 5". Blunt points are file cut and fit squarely together.
SB12148 — \$3.75



Stoddard's Test Tube Clamp

Brass-plated brass spring wire. Maintains spring strength indefinitely.
SA04398 — \$2.15



Test Tube Clamp

For test tubes (Stoddard) with finger grips. Self-closing jaw. Steel wire brass finish. Jaw opening up to 1" dia. 5".
SB10759 — \$2.95



Beaker Tongs

For beakers 50 to 2,000 ml capacity. Flat riveted joint. Maximum jaw opening: 4½". 10". Plated steel with plastisol jaws.
SA04392 — \$10.15



Laboratory Scoop

For scooping out small or large amounts of chemicals from bottles, etc. Stainless steel. Semicircular cross section with pointed end and blunt end. 6½" without handle.
SB08211 — \$1.50



Crucible Tongs — Standard

For handling and moving apparatus that cannot be touched by hand. Serrated gripping surface. Steel, nickel-plated. Resists rust. 9".
SB15254 — \$6.95



Nuffield

Stainless steel. ⅞" x ½" scoop end and 1⅝" x ⅜" flat end. 5⅞".
SB50471 — \$1.80



Deluxe Flask Tongs

Stainless steel. 11⅜".
SB49821 — \$14.50



Micro Spatula

Stainless steel (10–13% nickel) wire. Approximately 7". Wire: 0.156" dia. Flat ends: 2"L. Mirror finish.
SB08213 — \$3.15



Microspoon/Spatula

Nickel/stainless steel, mirror finish. 23 cm. Flat end length: 50 mm. Spoon end: 27 x 13 mm.
SB21567 — \$5.95



Micro Spatula/Scoop

Stainless steel. 1¼" scoop at one end and 1½" flat spatula on other end. 7¼".
SB46828 — \$8.95



Lab Tool Kit

Crucible tongs, test tube clamp with finger grips, test tube brush, spatula with flat end and spoon end, tweezers/forceps, lab scoop, and reclosable poly bag.
SB31101 — \$18.95



Burette Clamp
Symmetrical. Improved type. Plated jaws, aluminum muff. Fits rods up to 3/4" dia.
SBI8966 — \$7.50



Burette Clamp
Symmetrical. Round, plastisol-coated jaw with 3/8" to 1 3/8" opening. 6 3/8". Clamp fits rods up to 3/4" dia.
SBI8967 — \$10.50



Burette Clamp — "V" Jaw
Holds small objects. One jaw is flat; the other is "V" shaped with an opening of 3/16" to 1 3/8". Fits rods up to 3/4" (19 mm). Plastisol-coated jaws.
SBI8968 — \$6.95



Thermometer Clamps
Adjustable 360° jaw rotation for attaching up to 3/4" (19 mm) dia. rods. Aluminum muff, with steel thumbscrew, phosphor-bronze jaws. Maximum length from jaw to muff: 4 3/8" (111 mm). 5 1/2" (140 mm).
SBI8969 — \$7.95



United Scientific 3-Prong Clamp with Flexible Extension Rod
Gr. 5+ The 3-prong clamp features a 12" flexible extension rod that is extremely versatile and can be placed in any position or angle. Connector securely attaches to support stands, lab frames, or any support rod up to 19mm diameter. It holds up to 2 lbs.
NE30286 — \$63.95



United Scientific Right Angle Clamp Holder
Gr. 5+ This heavy-duty, cast aluminum clamp holder is for use with rods up to 19 mm in diameter. For use when clamping at 90° is required. Features a minimum to maximum grip range of 0 to 21mm and a v-groove bearing length of 55 mm.
NE30287 — \$9.95



United Scientific Adjustable Stainless Steel Double Burette Clamp
Two sets of jaws secure two burettes or cylindrical tubes simultaneously. Stainless-steel, PVC-coated jaws open from 15 mm to 45 mm (1/2" to 1 3/4") and can be swiveled and locked at any angle up to 90°. Aluminum bosshead attaches to rods up to 13 mm (1/2") OD.
NE30453 — \$24.95



Universal Clamp with Holder
Vinyl-coated three-pronged jaws that open up to 2 1/4". Fiberglass sleeves. Clamp holder can be rotated 360°.
SB47055 — \$20.50



United Scientific Chain Clamp
Hold objects that are too large for standard clamps with this handy chain clamp. Chain is 21"L and can be adjusted to support apparatus from 2" to 6 1/2" in diameter.
NE30454 — \$31.00

PRECISION STARTS WITH A FIRM FOUNDATION

Get high-quality support for reliable results



A. Ring Stand — Rectangular Support
Heavy black enamel cast iron base with plated rods. Enamel coating is acid-resistant. Rods are nickel-plated steel and threaded to fit the base.
SBI4023 4" x 6 3/4" base size, 5/16" x 18" rod — \$17.95
SA04429 5" x 8" base size, 3/8" x 20" rod — \$20.95

B. Burner Tripods
Supports small objects. Legs are detachable. Black enameled cast iron.
SBI4033 9", 3 1/2" O.D. — \$16.95
SBI4034 9", 5" O.D. — \$16.95

Ring Stand — Rectangular Support
Heavy, rectangular, stamped steel base. Chrome-plated steel rod.
SBI4025 4" x 6" base size, 5/16" x 18" rod — \$15.50
SBI2181 5" x 8" base size, 3/8" x 20" rod — \$19.75
SBI4026 6" x 9" base size, 1/2" x 24" rod — \$23.95

C. Support Rings
Cast iron with clamp for attaching to 5/16" to 5/8" ring stand rods.
SA04473 3" O.D., 2 1/2" I.D. — \$8.75
SA04474 4" O.D., 3 1/2" I.D. — \$10.00

D. Wire Ring Support
Formed, heavy, aluminum-plated, bright steel wire ring with extension arm and "V" clamps which will fit rods up to 5/8" dia. 3".
SBI8971 — \$8.95

E. Ring Stand — Triangular Support
Triangular cast iron base, heavily enameled, with plated rods. Enamel coating is acid-resistant. Rods are nickel-plated steel and threaded to fit the base.
SA04544 4" base legs, 3/8" x 20" rod — \$14.75
SBI4028 5" base legs, 1/2" x 24" rod — \$20.95
SB37527 6" base legs, 1/2" x 36" rod — \$26.95

F. Ring Stand Set
Heavy 4" x 6" base, 18" rod, and 2 cast iron support rings (3" and 4") with clamps.
SB34800 — \$32.95

Don't see it here? Find it at nascoeducation.com

**BEST
SELLER**



Student Glassware Assortment

Selection for one lab station in a general science, physical science, or general chemistry laboratory. Designed for 2-5 students.

Contains the following:

- 2 bottles, 4 oz., with screw caps
- 2 burettes without stopcocks, 50 ml
- Crucible, #0
- Crucible cover
- Dropper, pipette
- 6 dropping bottles, ½ oz.
- Evaporating dish, 75 mm
- 250 ml flask, Erlenmeyer
- 75 mm funnel, short stem
- 20 cm glass stirring rod
- 75 mm watch glass
- Mortar and pestle
- 2 petri dishes, 100 mm

Beakers:

- 100 ml (2)
- 250 ml (1)
- 400 ml (1)

Graduated Cylinders:

- 10 ml single scale
- 25 ml single scale
- 50 ml double scale
- 100 ml double scale

Test Tubes:

- 13 x 100 mm (6)
- 18 x 150 mm (6)
- 25 x 200 mm (6)

Glass Tubing:

- Capillary 1 mm I.D. x 30 cm
- 6 mm x 30 cm
- 10 mm x 30 cm
- 12 mm x 30 cm

⚠ CHOKING HAZARD (1). Not for under 3 yrs.

SB18006 – \$239.95



Chemistry Labware Kit

Assortment of items most commonly used in a general chemistry lab.

Contains:

- 2 Barnes dropping bottles, 30 ml
- 6 plastic dropping pipettes
- 50 ml glass beaker
- 100 ml glass beaker
- 250 ml glass beaker
- 2 ¼" dia. porcelain evaporating dish
- 6 glass stirring rods, 8"
- 125 ml glass Erlenmeyer flask
- 250 ml glass Erlenmeyer flask
- 6 glass test tubes, 1/16" x 5 7/8"
- 10 ml polypropylene cylinder
- 50 ml polypropylene cylinder
- 100 ml polypropylene cylinder
- 5"L stainless steel forceps
- 9"L steel crucible tongs
- 3 1/16" dia. long stem glass funnel
- 2 1/16" dia. plastic funnel
- Brass test tube clamp with finger grips
- 5" x 5" wire gauze with ceramic center
- 25 ml porcelain crucible with lid
- 2 1/16" dia. watch glass
- Plastic scoop
- Stainless steel spatula with 3"L blade and wooden handle
- 3 solid rubber stoppers
- 1-hole rubber stoppers (3)
- 2-hole rubber stoppers (3)

SB49823 – \$84.95



Distilling Apparatus

Gr. 7+ No two liquids have exactly the same boiling point. Therefore, it is possible to separate any mixture of two liquids by raising the temperature of the mixture to a point where one of the liquids will boil but the other remains liquid. Kit consists of 300 mm Leibig condenser, 50 mm dia. Kjeldahl ball, 500 ml boiling flask, cast iron base with support rod, clamp, tripod, wire gauze, and a 500 ml Erlenmeyer flask. The comprehensive instruction manual discusses how this process is applied in various industries, such as the oil industry.

SB39318 – \$84.95



Laptop not included

SB50672



SB50671

SB50672

NeuLog Communication Modules

Data logging platform with plug-and-play technology. Just plug up to 10 logger sensors into module and begin experiment. No calibration or setup time required. Each sensor stores up to 5 experiments in flash memory. Send data in digital form to computer or smart device. Sensors accommodate experiments lasting up to 31 days. Module software includes online and offline modes, tables, graphs, data analysis, double axis setup, statistic operations, and mathematical operations. Free browser-based software will work with any hardware. **NOTE:** Wireless (SB50671) or USB module (SB50672) is required to operate any of the sensors listed below.

Wireless Module. Connect any NeuLog sensor to any computer or smart device using Wi-Fi.

SB50671 – \$200.00

USB Module. Plug into USB port of a computer, then plug sensors into module, which provides both power from the PC to the sensors and the communication between them.

SB50672 – \$58.95

NeuLog Logger Sensor - CO2

Based on an electromechanical reaction between CO2 gas and the sensor. The result of the electromechanical reaction is voltage, measured by the logger sensor. The measure units are ppm (parts of CO2 per million of air). Features 14 bit ADC resolution, resolution of 1 ppm, and a maximum sample rate of 100 S/sec. Accommodates experiments lasting from 1 second to 31 days. **NOTE:** The wireless or USB module is required to operate any of the sensors.

SB51188 – \$325.00

NeuLog Logger Sensor - Oxygen

Take measurements of the level of free oxygen in air or dissolved oxygen in water. The free oxygen in air mode is used to measure changes in oxygen levels during combustion or in reactions that produce oxygen. Features 13 bit ADC resolution, resolution of 0.1% (in air/dissolved) or 0.01 mg/L (dissolved), and a maximum sample rate of 100 S/sec. Accommodates experiments lasting from 1 second to 31 days. **NOTE:** The wireless or USB module is required to operate any of the sensors.

SB50677 – \$300.00

NeuLog Logger Sensor - Wide Range Temperature

Based on a thermocouple sensor that enables measuring very low temperature levels and very high temperature levels, even the temperature of a flame. Measures both Celsius (-200° to 1200° C) and Fahrenheit (-328° to 2200° F). Accommodates experiments lasting from 1 second to 31 days. Features 10 bit ADC resolution, resolution of 0.1° F (0.1° C), and a maximum sample rate of 100 S/sec. **NOTE:** The wireless or USB module is required to operate any of the sensors.

SB51902 – \$85.00

PocketLab Sensors

Explore the world like a true scientist, with curiosity and a thirst for discovery. Utilizes a platform that enables hands-on science investigations through easy-to-use, inexpensive wireless sensors and apps. Wireless multi-sensors explore the impact of climate change, the flight data of a drone, how to program a robot, and more. Ideal for maker projects and science experiments. Open access to over 35 online experiments and demos. Wireless range: 250' (76 m) line-of-sight. Onboard memory: 32,000 data readings. Rechargeable battery provides over 40 hours of use per charge during wireless operation. Bluetooth® 4.0 wireless connection. PocketLab app is compatible with iOS, Android™, Windows® 10, Mac OS®, and Chromebook™. 1 1/2" x 1 1/2" x 3/8". ⚠ CHOKING HAZARD (1). Not for under 3 yrs.

A. Voyager 2. All-in-one science lab that is capable enough for a professional engineer and simple enough for a fourth-grade student. Voyager can measure motion, light, magnetic fields, and weather, and can connect to an external temperature probe. Attach PocketLab Voyager to a drone to measure the altitude and vibrations during a flight, put it inside a football to measure the rotation of a spiral throw, and design and build rubber band cars to measure their speed during a race.

NA10342 – \$198.00

B. Weather. A rugged weather center that can measure temperature, humidity, light, barometric pressure, heat index, dew point, and can connect to an external temperature probe. Build a weather balloon and use PocketLab Weather to gather climate data as it travels through the sky and discover why lightning strikes by observing changes in atmospheric data during a storm.

NA10341 – \$128.00



EXCLUDED FROM DISCOUNTS

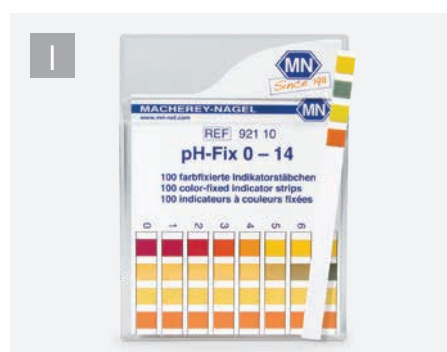
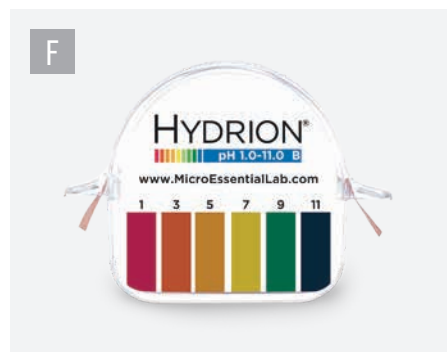

pHydrion Insta-Chek 0-13
Direct reading pH paper has the widest range (0-13) available in a single paper. Simple, single color match for all pH values. One paper gives 14 colors, providing instant pH checks over entire range. Accurate, reproducible readings provide immediate response.

A. Jumbo. Single-roll dispenser with 50' roll of tape and color chart.
SB13596 — \$14.00

B. Standard. Double-roll dispenser with 2 rolls of 15' x 7/32" tape and 2 color charts.
SB13598 — \$14.25

Standard Refill Package. 5 rolls of 15' x 7/32" tape for SB13598 dispenser.
SB13599 — \$28.00

C. Hydrion pH Strips 1-12
Wide-range, general purpose test papers have a distinct color match at full pH units 1-12. 100 per vial. 4 1/2" x 3".
SB51250 Per vial — **\$3.25**
SB51251 10 vials — **\$26.95**
Jumbo pH Strips. 8" x 3/4". Pack of 5.
SB51252 — \$25.50

D. Hydrion Spectral Plastic 0.0-14.0 pH Strips
Premium-quality, wide-range plastic strips offer clear, bright, single-color matches. Dip strip into test solution, then instantly compare color with matching pH color chart. 100 strips in flip-top vial. 1.0 interval.
SB48831 — \$13.75

E. Mikro Refill Package
Pack of 5 rolls of 15' x 7/32" tape.
SB10879 — \$25.00

F. pHydrion pH Paper 1-11. Determine pH over a range of 1-11. Two 15' rolls in plastic dispensing case.
C08835 — \$13.49

G. PEHANON® Test Strips 1-12
pH indicator and reference colors are on one strip. Sample color has same effect on both reference colors and reactive pad. Invisible hydrophobic barrier just above top color field. Handle remains dry and clean. Single strips can be used with color chart to determine pH values. Gradations range from 1-12. Box of 200, 11 x 100 mm.
SB50371 — \$27.95

H. Wide-Range pH Paper
Provides distinct color for each separate pH reading in the range of 1-14. 100 strips per pack.
SB08261 — \$3.75

I. pH-Fix Test Strips
Long handle prevents fingers from coming into contact with the sample. pH indicator is chemically bound to the cellulose fiber. Four different color blocks for each pH value (0-14) ensure precise pH determination. 100 test strips, 6 x 85 mm.
SB50372 — \$18.50

That's just the start!
See more options at
nascoeducation.com

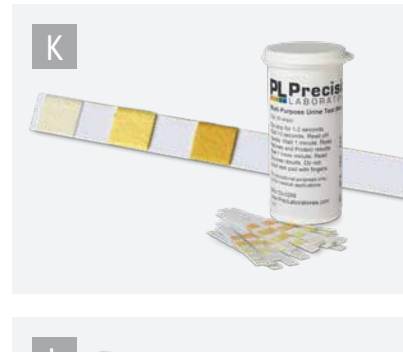

J. Test Papers
100 strips (2" x 1/4") per vial.

Product No.	Description	No. of Vials	Pack
SB14759(A)	Litmus, Blue	12	\$17.00
SA07854(A)	P.T.C.	12	\$30.00
SB10904(A)	P.T.C. (control)	12	\$20.00

K. Urine/Glucose Test Strips
Multiple test strip for conducting urine tests for pH, glucose, ketones, and protein. 50 strips.
SB31063 — \$35.95

L. Litmus Strips
Standard indicators for acids and bases. 100 blue and 100 red strips.
SB50608 — \$3.75

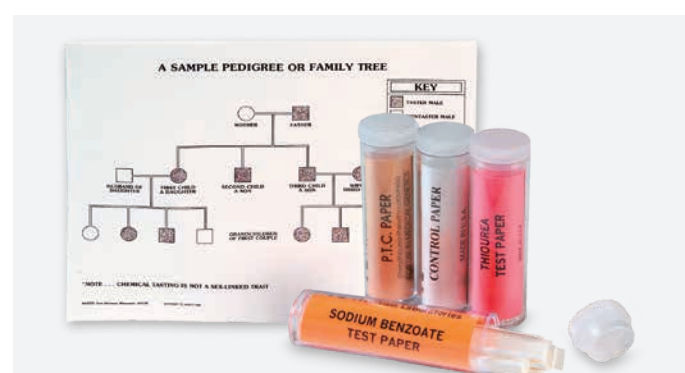

Human Genetics Taste Paper Set
Test the genetically determined taste response of students and families to three different chemicals. Four vials each contain 100 papers. **NOTE:** Some school systems ban the placement of anything in the mouth during a science class or the use of PTC taste papers. Abide by your system's state and local regulations. If you cannot use PTC taste papers, you can investigate other human genetic traits such as earlobe attachment or the ability to roll your tongue.
SB11123 — \$8.95



PH-200: Waterproof Professional Series pH/Temp Meter
Advanced microprocessor provides accurate readings in applications like hydroponics, purification applications, wastewater regulation, aquaculture, ecology testing, water treatment, agriculture, and more. Waterproof housing is submersible and floats (IP-67 rating). Digital automatic calibration (1 point) with digital fine tuning. Features automatic temperature compensation (ATC), auto-off function, data-hold function, and low-battery indicator. Easy-to-read LCD screen with simultaneous temperature display. Factory calibrated to pH 7.0 and three-point checked. pH range: 0-14. 7 7/16" x 1 1/16" x 1 1/16". Includes batteries, translucent cap, lanyard, and pH 7.0 buffer (sachet).
C35311 — \$99.95



Test Tube pH Pen
Large LCD display. One-hand operation. Fits into standard test tubes 16 x 50 mm or larger. Automatically calibrates to pH 4, 7, and 10 buffers. Adjust to recognize any buffer. Features hold function, auto power off, low battery indicator, waterproof case, and built-in electrode kept moist with protective cap.
SB52136 — \$62.00



Portable Refractometer
Measures protein concentration, urine specific gravity, or gives the refractive index in seconds using only a few drops of blood serum, plasma, urine, or albumen. Works in ambient light with no power source necessary. Rubber-coated hand grip, covered eye piece, clearly defined scale with large measurements, and all accessories necessary for immediate use. 6 3/4" x 1 1/2".
SB48374 — \$97.95



Wider and heavier base

Natural Gas No-Tip Bunsen Burners

Expanded base prevents easy tipping. Spaced feet allow burner to fit comfortably under stands. Includes carry handle.

Basic. Airflow adjustment sleeve. 5¹/₁₆" (145 mm).
SB52635 – \$18.95

Standard. Flame stabilizer and gas adjustment needle valve. 6⁵/₁₆" (160 mm).
SB52637 – \$24.95

Tirrill. Wing nut for gas adjustment. Tube screws for air-to-fuel adjustment. 5⁷/₈" (150 mm).
SB52639 – \$33.95



We suggest using ethyl alcohol, 95% denatured (ethanol), for these alcohol lamps. See p. 115 for ethyl alcohol listing.

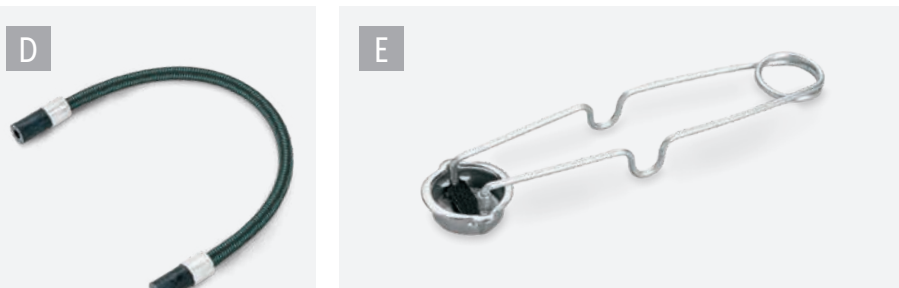

A. Tirrill Burner – Natural Gas

Noiseless burner allows separate control of both flame temperature and length. Clean flame from 1/2" to 12". Rustproof. Nickel-plated, one-piece, die-cast base and serrated gas inlet. Aluminum mixing tube. Threaded aluminum air control sleeve, brass needle valve, flame stabilizer.

SB07242 – \$38.50

B. Safety Alcohol Burner and Stand Kit

Burner fits into a recess in the stand so that it is almost impossible to tip while in use.

SB10930 – \$14.95

Replacement Wicks. Pack of 12.

SB14308 – \$6.95

C. Alcohol Burner

Flat-bottom alcohol burner has a safety cap to prevent alcohol evaporation. 3³/₄" dia. with 1/4" wick. Split-sleeve wick adjustment. 4 oz. **CHOKING HAZARD (1).** Not for under 3 yrs.

SB34435 – \$6.00

D. Bunsen Burner Connecting Tubing

Galvanized, flexible steel tubing with gas-proof rubber insulation covered with cotton braiding to meet American Gas Association standards. Rubber connector ends attach to standard 3/8" nipples. Can be used with Tirrill burners and other high-temperature burners.

SB10461 2' – \$16.95

SB10462 3' – \$20.95

E. Spark Lighter – Hooded

Safer to use than matches. Sparks ignite combustible vapor only. Comes with replaceable tip.

SB16654 – \$4.05

Replacement Flints. Pack of 10.

SB16655 – \$5.95



EXCLUDED FROM DISCOUNTS

Digital Melting Point Device

Determines the melting point of a substance without needing a mercury thermometer. Digital LED temperature display has a 0.1° C resolution. Adjustable speeds have indicator lights (Heating, Fast, Slow) advising procedure in process. View up to 2 samples with magnifying lens and built-in LED light. Includes a manual with detailed use instructions and a pack of 100 glass capillary tubes, open on one end. 120V, 60Hz. Temperature range from ambient temperature up to 300° C, with an accuracy of ±1° C at 20° C and ±2.5° C at 300° C. 8¹/₁₆" x 6⁵/₁₆" x 6¹/₁₆". Allow extra delivery time. **CHOKING HAZARD (1).**

Z48577 – \$1,404.95



Portable Butane Burner

Compact burner with adjustable flame control lever, safety mechanism turn off stopper, built-in pressure release valve, and a non-tip wide base. Automatic ignition and refillable. 24 oz.

NE30217 – \$50.00

Butane Fuel. Prevents clogging. Provides a cleaner burn. Universal filling tube and added odorant to detect leakage. 3.38 oz. NOTE: Any quantity may be shipped without hazardous materials charge.

◆ SB38457 – \$8.50



Butane Lab Burner

Fingertip valve adjustments for flame control. 5.5-oz. container of fuel fits under 9" tripod. Delivers a hot, clean flame to 3,000° F for 5 1/2 hours from a single disposable fuel container.

◆ SB16434 – \$59.95

Replacement Fuel Tank (5.5 net oz.) Only

◆ SB16435 – \$13.25

△ See page 3 for complete Choking Hazard Label Information.

◆ DOT hazardous material ◆ Subject to DOT hazardous material surcharge.

BEST SELLER

Single Electric Burner

Die-cast, flat burner features high, medium, low, and warm temperature settings with a power-on safety indicator light. 9 1/2" x 8 1/2" x 3".

WA26024 – \$24.95



United Scientific Eco-Heat Hot Plate

Gr. 9–12 Aluminum top hot plate features powerful 500W heating element and reaches up to 280° C. Automatically stops when maximum temperature is reached. Stirring function operates at speeds from 0 to 1,600 rpm.

NE30228 – \$164.95



Corning® Scholar® Hot Plate

White enameled steel top plate. Dual heat shields dissipate heat and keep case cool to the touch. Temperature range: 77° F to 672° F (25° to 360° C). 5" x 5" x 4". 120V power. UL/CUL approved.

SB45547 – \$224.00



Corning® Hot Plates (Without Stirrer)

Maintains consistent and repeatable temperature settings from 5° C (if ambient temperature is 0° C or lower) up to 550° C. Digital LED temperature display is adjustable in 5° C increments. Bright LED "hot top" icon lights up when top plate is over 60° C. 120V/60 Hz with three-prong plug. UL and CUL approved.

SB41623 Digital, 5" x 7" – \$365.00

SB28687 Analog, 4" x 5" – \$300.00



EXCLUDED FROM DISCOUNTS

**BEST
SELLER**



United Scientific Eco-Stir Magnetic Stirrer
Gr. 9-12 Designed for use with low viscosity liquid or a solid liquid mixture. Includes power adapter and user manual. Mixing speed goes up to 2000 rpm.
NE30230 — \$109.95

SAFETY. EFFICIENCY. CONTROL.

Get precise and consistent mixing of solutions every time



Magnetic Stirrer with Heater

Simultaneously stirs and heats liquid. Totally enclosed, cast aluminum heating surface resists chemical spills. Separate dials regulate stirring speed and temperature. Has 1" octagon stir bar with molded-on pivot ring in center, detachable 1' support bar with thermometer/pH probe clamp, and detachable power cord. Stirring capacity: up to 500 ml with a strong vortex. 180 watts. Temperature max.: 480° F (250° C). 120-1600 rpm.

5" x 5"
SB48265 110V — \$195.00

7" x 7"
*SB51127 110V — \$260.00
*SB52703 220V — \$255.00

*EXCLUDED FROM DISCOUNTS



EXCLUDED FROM DISCOUNTS

Corning® Stirring Hot Plates

Closed-loop stirring control monitors and regulates stirring speed from 60-1,150 rpm for aqueous, viscous, or semi-solid solutions. Stronger, larger magnet improves stir bar coupling. Automatic ramp up speed adjustment minimizes decoupling.

SB42262 Digital, 5" x 7" — \$600.00
SB50648 Analog, 4" x 5" — \$575.00



United Scientific Eco-Mix Vortex Mixer

Gr. 9-12 Mixer features simple touch-and-go functions. Small, compact design will save storage space. Delivers robust vortex mixing at 3000 rpm.
NE30227 — \$158.95



United Scientific Eco-Spin Mini Centrifuge

Gr. 9-12 Bench-top mini centrifuge includes 12-position 2 ml tube rotor and 4-position, 12-strip PCR tube rotor. Holds 48 PCR tubes or 0.2 ml strip tubes. 4000 rpm maximum speed.
NE30229 — \$159.95



Spinplus 8 Rotor Centrifuge

- Gentle braking at low speeds
- Efficient separation and braking time (20-80 seconds) can be adjusted for the 0-5,000 rpm speed
- LCD display can change between rpm and RCF setting
- Separate short spin button for quick spins
- Run operations anywhere from 10 seconds to 99 minutes
- Bell signal and automatically opening safety-lid indicates operation has finished

SB52593 — \$435.00

EXCLUDED FROM DISCOUNTS



E8 Centrifuges

- Accommodates most test tubes from 3-15 ml
- Wide stance and suction-cup feet eliminate wobbles, vibrations, and slipping
- Brushless motor is virtually maintenance-free
- Auto switching between 110V and 220V
- Includes 8-place tube rotor, 8 tube sleeves (15 ml), and 8 tube sleeve inserts (13 x 75 mm)
- 3,300 rpm fixed speed
- Auto-off 30-minute timer with bell
- Maximum RCF: 1,350 g
- 10" x 10" x 10"

SB46439 — \$450.00



Conical Bottom Centrifuge Tubes

Sterile, 50 ml conical-bottom tubes feature screw-top lids, easy-to-read black graduations, and writing area. Suggested use in temperatures between 0° to 40° C. Pack of 50.
SB45966 — \$14.95



Foam-Racked Centrifuge Tubes

15 ml tubes have screw top with easy-to-read white graduations. Clear, polypropylene, conical bottom tubes with writing area. Working temperature range: 0° to 45° C. Pack of 50 in foam rack.
SB43474 — \$36.95



Colored Plastic Rack with Tubes

Set of 15 ml plastic tubes comes with two-tiered test tube stand. Tubes feature screw tops and graduated markings.
SB44477 — \$11.95



United Scientific Centrifuge Tube Brushes

Gr. 5+ Effectively clean centrifuge tubes, vials, small funnels, and more in the lab with these centrifuge brushes. Features tapered white nylon bristles with white nylon fan tip. Cleans tubes in various sizes. Packs of 12.
NE30295 4½" Brushes — \$20.15
NE30297 6" Brushes — \$26.50



EXCLUDED FROM DISCOUNTS

Lab Incubators

Maintains temperatures up to 62° C accurately and uniformly. Sensitive heat controller maintains temperatures to ±1° C. Minimum temperature: ambient +2° C. Beakers, flasks, petri dishes, and test tube trays can be processed at the same time. Safe, non-mercury spirit thermometer. Shielded heater protects against spills. UL listed, see-through door. Aluminum interior. No assembly required. 120V AC, 120 watts for 0.7 cu. ft. and 235 watts for 2.0 cu. ft., three-prong grounded plug.

0.7 cu. ft. Capacity. Interior: 12" x 10" x 10". Exterior: 12⁷/₈" x 10³/₄" x 15". SB21186 – \$555.00

2.0 cu. ft. Capacity. Interior: 18" x 12" x 16". Exterior: 19" x 13" x 21". SB26217 – \$753.00



EXCLUDED FROM DISCOUNTS

Digital Incubators

Full PID microprocessor-controlled units maintain accurate temperature settings within ±½ ° C even in varying ambient or power supply conditions. Large, low-glare, four-digit LED display can be easily read across the room. Selectable °C or °F unit read-out. Continuous self-diagnostic function prompts if control software malfunctions or thermocouple fails. Minimum temperature: ambient +2° C. High-grade aluminum interior, cold-rolled powder-coated steel exterior, and bronze acrylic see-through door. UL listed.

0.7 cu. ft. Capacity. 7 shelf positions. Z30660 – \$823.00

2.0 cu. ft. Capacity. 13 shelf positions. Z30661 – \$1,088.00



United Scientific Eco-Heat Heating Mantle

Provide uniform heating to round-bottom flasks up to 250 mL capacity. Heating function: Electronic thermo-regulation. Heating power: 100W–2400W. Max heating temperature: 380°C. Operates on 115V/60 Hz. NE30455 – \$106.95

Electro-Thermal Constant-Temperature Water Bath

Easy-to-read digital display. Stainless steel inner reservoir. Cover with removable open ring covers allow beakers and flasks to be used while limiting water evaporation. Intelligent temperature controller with PID program. Over-temp protection.

4 Liters
SB49827 – \$375.00

8 Liters
SB49826 – \$500.00



SB49827



SB49826



EXCLUDED FROM DISCOUNTS

Gravity Convection Laboratory Oven

Used for drying, baking, sterilizing, evaporating, heat treating, annealing, and testing. Automatic thermostat controls temperature. Heat shield absorbs radiant heat and distributes it more evenly. 3 racks (top and middle are adjustable). 0.7 cu. ft. Safe non-mercury spirit thermometer. I.D.: 12" x 10" x 10". O.D.: 14" x 17" x 12". Maximum temperature: 450° F (232° C). Minimum temperature: ambient +25° F. Z30662 – \$670.00



Bell in Vacuum – Glass

Gr. 6+ Prove sound waves won't travel through a vacuum. Electric bell may be removed from jar for other vacuum experiments. Inside height: 8"; dia.: 6¹/₄". Also includes base plate with seal and instructions. SB44677 – \$99.95



EXCLUDED FROM DISCOUNTS

Mobile Ductless Demonstration Fume Hood

No installation or ducting required. Self-contained, integrated system is ideal for fixed location or mobile applications. Ductless fume hoods isolate and trap chemical vapors to prevent ecological impact through release into environment. High-efficiency carbon filtration and air management system protects both the user and the classroom environment from hazardous vapors generated on and above the work surface. Clear walls permit 360° visibility, perfect for individual and group applications. Improved filter clamping prevents bypass leakage and allows filters to be easily changed, no tools required. Low airflow alarm warns of unsafe conditions, and electronic process monitoring ensures continuous safety. Mounted on a heavy-duty wheeled transfer cart with a small side storage compartment. Sized to fit through standard doorways for easy transportation from lab to lab. Meets ANSI, OSHA, AFNOR, and BSI safety standards. 110V. Available in 220V as a special order (please specify plug type when ordering). 28¹/₂" x 39¹/₂" x 77¹/₂"; 31¹/₂" internal height. Filter included. NZ10470 – \$5,000.00



Two-Stage Laboratory Vacuum Pump

Small, lightweight, and portable. Powerful, high-performance pump comes ready to operate. Free air displacement: 2.5 cu. ft./min. at 50 Hz and 3.0 cu. ft./min. at 60 Hz. Motor: ½ HP. Oil capacity: 250 ml. Comes with initial supply of high-vacuum pump oil. 115V, 60 Hz. SB47761 – \$350.00



Hand-Operated Vacuum Pump

PVC pump provides a vacuum of 50 mmHg or air pressure of about 2 atm with a few squeezes of the handle. Sealed and self lubricated. Pumping rate of about 15 ml per pumping. Removable cap. Elastic valve fixed on outer port provides quick vacuum release. Fits standard ¼" tubing. Includes 1' of tubing. SA08839 – \$38.95

1-Gallon Vacuum Chamber – Thermo Scientific Nalgene®

Unbreakable polycarbonate bell jar with polypropylene vacuum plate and ¼" tubing connection at rim. Connects to any vacuum source or mechanical pump. Will withstand full vacuum. Do not autoclave. Intended only for student demonstrations of vacuum procedures. SA08835 – \$250.00





SA04387

OHAUS® Triple Beam Balances

Die-cut construction withstands overloads and delivers accurate results for years. Ensures easy reading, quick zeroing, and repeatable results. Magnetic dampening minimizes oscillation and speed weighing. Spring-loaded zero adjust compensator. Deep notched and tiered beam. Capacity: 610 g. Purchase optional attachment weights (SA04482, below) to increase capacity. Sensitivity: 0.1 g.

Product No.	Model	Platform Type	Tare	Each
SA04387	750-S0	Stainless steel platform	No	\$208.00
SA09238	760-00	Stainless steel platform	Yes	\$375.00
SA09229	710-00	Stainless steel pan	No	\$345.00



Attachment Weights or Triple Beam Balances

One 500 and two 1,000 gram weights. SA04482 – \$99.95



OHAUS® Model 311 Balance

Positive poise positioning. Notched and tiered beams. Magnetically damped to slow oscillation. Spring-loaded zero-adjust compensator. Sensitive to out-of-level conditions. Agate bearings, steel knife edges, and stainless steel pan ensures resistance to rugged handling. Raise platform recessed in base for specific gravity determinations (apparatus included). Capacity: 311 g. Sensitivity: 0.01 g. S00914 – \$445.00

OHAUS® Triple Beam Balance

Patented design includes notched and tiered beams, magnetic dampening, and zero adjust compensator. Security loop connection allows the use of any cable that can be looped through back. Capacity: 610 g with 0.1 g sensitivity. Capacity can be increased to 2,610 g by purchasing optional attachment weights (SA04482, right).

TB24105 – \$197.00

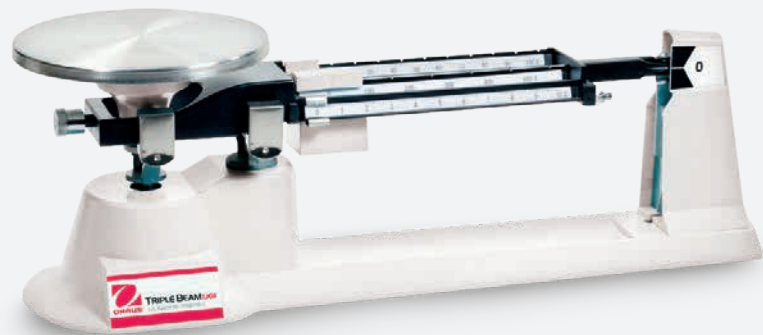

Adam® TBB Triple Beam Balances

Factory-installed security slot built right into metal housing. Three graduated-tier beams for best center-point readings. Speedy zeroing with counterbalance knob. Integral weight-below hook. Built-in mass holder. Stainless steel pan. Conversion chart and ruler on housing. 0.1 readability.

2,610 g. Built-in tripod legs.
SB42617 Without Tare – \$170.00
SB42618 With Tare – \$200.00

610 g. Without tare. Patented design.
SB44703 – \$135.00



SB44703

BEST SELLER

Nasco Triple Beam Balance

Die-cast construction, precision ground steel knife edges, dual magnetic dampening systems to slow oscillation, and large stainless steel weighing platform. 610 g capacity. Platform size: 15 cm.

SB43077 – \$122.95

Triple Beam with Weight Set. 2,610 g capacity. SB43078 – \$127.95

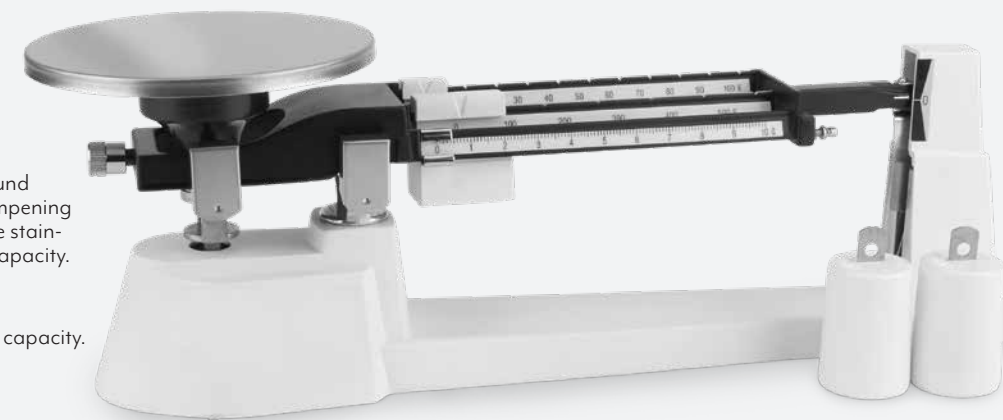

Nasco Double Pan Balance

Employs a two-pan design based on the classical Roberval balance principle. Commonly used for comparative weighing to determine the difference in mass between two objects. Capacity: 2,000 g. Notched and tiered beam. Sensitivity: 0.1 g. Platform size: 15 cm. Sliding weights on beams. SB42943 – \$157.95





Student Balance
Two 500 ml colored buckets with lids. Easy-to-use sliding zero adjustment. Capacity: 2,000 g. Readability: 1 g. Activity guide. **CHOKING HAZARD (I).** Not for under 3 yrs.
SA05379 — \$15.95



C



D



E



A



B

A. Simple Scale
Translucent, large-capacity pans marked at 200 ml increments hold up to 1 liter of liquid or solids. Compensator clips and 5 each of 1 g, 5 g, and 10 g stackable weights. Washable plastic. 29½" x 13". **CHOKING HAZARD (I).** Not for under 3 yrs.
TB15809 — \$13.95

B. Nasco School Balance
An inexpensive way to teach the same concepts learned when using more advanced mechanical weighing instruments. High-impact polystyrene plastic. Capacity: 2,000 g. Sensitivity: 0.5 g. Weight set contains three 10 g, two 20 g, and two 50 g weights. Activity guide. **CHOKING HAZARD (I).** Not for under 3 yrs.
SB34283 — \$33.95

C. Nasco Student Balance
High-impact polystyrene balance offers 2,000 g capacity and 1 g sensitivity. Features zero-adjust knob, 2 removable pans, and an 8-piece 1 g to 50 g weight set. **CHOKING HAZARD (I).** Not for under 3 yrs.
SB16480 — \$27.95

8-Piece Mass Set Replacement. Includes 1 each of 1 g, 10 g, 20 g, and 50 g weights; and 2 each of 2 g and 5 g weights. **CHOKING HAZARD (I).** Not for under 3 yrs.
SA05380 — \$13.95

D. OHAUS® Harvard Junior™
Metal beam, plastic base, and dual-style removable pans. Dampening feature. Zero-adjust knob. Built-in handles. Storage and transportation locking mechanism. Stackable (3 high). Eight-piece metal mass set (2 each of 10 g, 25 g, 50 g, and 100 g). PreK-5 focused Science/Math activity guide with 7 activities, background information, and assessment suggestions. Capacity: 2,000 g. Readability: 0.50 g.
SB43546 — \$166.00

E. OHAUS® School Balance with Mass Set
Interchangeable pans are easily removable. Dual pointers allow viewing of results from either side of balance. Zero adjustment. Plastic balance. Capacity: 2,000 g. Accuracy: 0.5 g. Includes ten 1 g, four 5 g, two 10 g, and two 25 g plastic weights. Pan dimensions: 5½" x 5½".
SB31487 — \$89.00



Weight Sets Set of 54
See mass relationships at a glance. Each color represents a different thickness and mass. Twenty 1 g (blue), twenty 5 g (red), ten 10 g (yellow), and four 20 g (green). Stackable.
TB15543 — \$9.95



Student Standard Mass Set of 27
17 hexagram weights (10 red 5 g, 5 yellow 10 g, 2 green 20 g) and 10 Weight Too® two-color 1 g weights (red and yellow). **CHOKING HAZARD (I).** Not for under 3 yrs.
TB17619 — \$7.75



Nasco Interlocking Gram Centimeter Cubes
Each cube measures 1 cm on an edge, has a volume of 1 cm³, and has a mass of 1 g. Each surface is 1 cm². Bucket of 1,000. **CHOKING HAZARD (I).** Not for under 3 yrs.
TA02278 — \$19.95



Nasco Centimeter Gram Cubes
Each non-interlocking cube weighs 1 g. Set of 1,000 in 10 bright colors. **CHOKING HAZARD (I).** Not for under 3 yrs.
TB16756 — \$17.95

Polystyrene Weighing Boats
Lightweight, disposable weighing dishes can be used for liquids or solids. Suitable for all types of balances. Pkgs. of 500.
Square. Smooth surface and rounded corners. 3½" x 3½" x ¾".
SB16660 — \$47.95
Hexagonal. Flat bottoms and sloping sides. Nonreactive to most substances. Resists temperatures to 158° F (70° C). Flexible. 2½" x 2" x ¾".
SB48957 — \$51.95





OHAUS® Compact Scales

Features low-profile design, large high-contrast display, auto shut-off, digital calibration from keypad, overload and underload indicators, plastic construction, and zero range to capacity by subtraction. Optimum operating temperature: 64° to 77° F (18° to 25° C). Removable stainless steel pan size: 5⁵/₁₆" x 5". Overall dimensions: 7⁷/₁₆" L x 5⁵/₁₆" W x 1¹/₁₆" H. Requires 3 "AA" alkaline batteries (included) or AC adapter (included).

Product No.	Capacity	Readability	Linearity (g)	Weighing Units	Each
SB53213	220 g	0.1	±0.1	g and lbs./oz.	\$200.00
SB53216	2200 g	1.0	±1.0	g and lbs./oz.	\$210.00
SB53217	5200 g	1.0	±1.0	g and lbs./oz.	\$250.00

AC Power Adapter for OHAUS® Compass CX and Scout SKX Scales

5V AC power adapter.
NE30095 — \$38.50



OHAUS® Scout® Portable Electronic Balances

200-lb. static overload protection internally. Sudden impact protection protects load cell against shock caused by sudden impact. Shipping/storage lock. USB, RS232, Ethernet, USB host, and Bluetooth® connectivity options. Features improved stabilization time, multiple weighing modes, and menu lockout switch. Stackable excluding mg models due to integrated draft shield. Storage cover. Touchscreen models also feature a level bubble and adjustable feet. LCD display with backlight viewable from any angle. Requires 4 "AA" batteries (not included) or AC adapter (included).

Product No.	Model	Capacity	Readability	Pan Shape	Each
SB51728	SKX222	220 g	0.01 g	Round	\$605.00
SB51729	SKX422	420 g	0.01 g	Round	\$848.00
SB51730	SKX622	620 g	0.01 g	Round	\$995.00
SB51733	SKX421	420 g	0.1 g	Round	\$350.00
SB51735	SKX2201	2,200 g	0.1 g	Square	\$575.00



ONLY AT NASCO

Nasco Electronic Balances

Integrated weigh below hook, stackable design, shipping load cell lock, overload protection up to 200 lbs., 50 hours of battery life with auto shut off, security bracket (cable not included), and three-button human interface. USB and RS232 interfacing. Weighs in g and N only. Flip-top draft shield with integrated sample tray provides access to chamber through center opening. Top cover center opening is also a sample tray "weight boat" when removed and turned upside down.

SB42894 150 g x 0.01 g readability — \$435.00
SB42895 300 g x 0.1 g readability — \$254.00

BEST SELLER



SB53188

Balances for a wide range of general weighing applications in laboratory and education settings

OHAUS® Navigator® Balances

Features include touchless sensors, large LCD display, ultra-fast response time, and superior overload indicators. Stabilizes in less than 1 second. Capabilities include weighing, parts counting, percent weighing, check-weighing, totalization, and display hold. Displays 15 of the most common units of measurement. AC adapter (included) or 4 "AA" batteries (not included). 9¹/₁₆" L x 8" W x 2¹³/₁₆" H.

Product No.	Model No.	Capacity	Readability	Each
SB53188	NV222	220g	0.01 g	\$463.00
SB53189	NV221	220 g	0.1 g	\$272.00
SB53186	NV621	620 g	0.1 g	\$399.00
SB53185	NV1201	1,200 g	0.1 g	\$450.00
SB53181	NVT6200	6,200 g	1.0 g	\$595.00



SB53189



Classroom Compact Scale

An electronic classroom scale featuring a tare button, auto power off, and large digital display, plus a mode button for g, lbs., and oz. Capacity: 176.4 oz./5,000 g. Accuracy: 0.05 oz./1.0 g. TB22736 — \$47.95

BEST SELLER



Compact Digital Scale

An electronic classroom scale featuring tare button; auto power off; and large digital display; plus a mode button for g, lbs., and oz. Capacity: 176.4 oz./5,000 g. Accuracy: 0.1 oz./1.0 g. TB25722 — \$29.95



Digital Scale

Dishwasher safe bowl on base inverts for storage. Tare function. Capacity 4.40 lbs. (2 kg) in 1/8 oz. (1 g) increments. WA26488 — \$24.95



Platform Scale — 11 lbs./5 kg.

Dual-system scale has removable plastic pan; large, clear dial with metric and customary markings; and zero-adjustment wheel. 11 lbs./5 kg. TB15544 — \$14.95

PRECISION MATTERS

Weigh your options with portable and compact scales and balances

NEW



United Scientific Digital Pocket Scales

Four weighing modes: g, oz., ozt, and dwt. Features 55 mm x 55 mm weighing platform, tare function, auto shut-off after 60 seconds, and a dual-purpose cover/weighing tray. Uses 2 AAA batteries (included).

- NE30531 100 g—\$13.75
- NE30532 200 g—\$11.50
- NE30533 600 g—\$9.50



Ninja Scale Value Pack

Scale with high-impact plastic housing, stainless steel weighing pan, AC power adapter, 4 "AA" batteries, and plastic carry case. 2,000 g capacity. 1 g readability.

SB46572—\$179.95



OHAUS® Pocket Scales

Weighing pan is integrated right into carrying case. Hinged cover, plastic housing, and stainless steel weighing pan protect balance from damage. Mechanical and software over- and underload indicators preserve scale. Extremely fast stabilization time. Blue backlit LCD display. Power-saving auto shut-off feature. Measurement units include g, oz., carat, and grain. 4 5/16" L x 2 7/8" W x 1 3/16" H.

Product No.	Model No.	Capacity	Readability	Each
SB51432	YA102	100 g	0.01 g	\$138.00
SB51431	YA501	500 g	0.1 g	\$91.00



Adam® Core Balances

ShockProtect™ overload protection up to 400+ lbs. Built-in lock-down slot secures balance in one place. Below-balance weighing with hook for density calculations. Stainless steel weighing pan and removable draft shield (available on models with 4 3/4" pan size). Stackable. 6 3/4" x 9 5/8" x 3 1/8". Requires 6 "AA" batteries or AC adapter (adapter included).

Product No.	Model No.	Readability	Capacity	Pan Size	Each
SB45458	CQT 202	0.01 g	200 g	4 3/4"	\$315.00
SB45457	CQT 251	0.1 g	250 g	4 3/4"	\$175.00
SB46020	CQT 601	0.1 g	600 g	4 3/4"	\$250.00

Adam® Compact Balances

Stainless steel pan and solid ABS housing is easy to clean. Weighs in g, oz., and lbs. Keypad is sealed. Battery operation for use anywhere. 5 1/8" x 5 1/8" stainless steel pan. Requires 2 "AA" batteries (included) or AC adapter (not included).



Product No.	Model No.	Readability	Max. Capacity	Each
SB49642	CB 501	0.1 g	500 g	\$100.00
SB49643	CB 1001	0.1 g	1,000 g	\$110.00
SB49644	CB 3000	1 g	3,000 g	\$125.00



Adam® Dune Balances

Large 5 3/4" x 5 3/4" weighing pan. Displays results in g, oz., and lbs. Low battery indicator. Auto power-down saves battery life. Requires 6 "AA" batteries or AC adapter (included).

Product No.	Model No.	Readability	Capacity	Linearity	Each
SB47042	DCT 2000	1 g	2,000 g	±2 g	\$125.00
SB47043	DCT 5000	2 g	5,000 g	±4 g	\$130.00

Adam® balances provide great value with smart features that make everyday lab work quick and easy. Quality construction with solid housing ensures durability for years of use. With over three decades of manufacturing balances, Adam Equipment stands behind its products.

Personalize your scale with one of the included color bars



SB49333



SB49998

Compact Scales

Easy-to-read 13.5 mm H LCD digital display. Selectable from g, oz, ozt, lb-oz., N, tael, and tola (lb-oz. not available for SB49333). Use one of three included color bars to personalize scales. Display automatically turns off after 5 minutes of inactivity. Approximately 450 hours of battery life. Security slot in rear for anti-theft lock. Stackable carry case allows scale to be used without removing it from case. Pan size: 5 3/16" x 5 1/8" without stainless steel pan. Overall dimensions: 7 1/16" x 5 3/8" x 1 3/4". Requires 4 "AA" batteries (included) or AC adapter (not included).

Product No.	Model No.	Capacity x Resolution	Each
SB49998	HT-120	120 x 0.01 g	\$305.00
SB49333	HT-300	310 x 0.1 g	\$160.00
SB49334	HT-500	510 x 0.1 g	\$190.00

BEST SELLER



Dual-Calibration Spring Scales

Provides direct readings for both force and measurements. Calibrated in both Newtons and grams. Top is leveled for easy use with an inclined plane.

Product No.	Capacity	Each
SB42822	100 g/1 N	\$4.95
SB18125	250 g/2.5 N	\$4.95
SB14406	500 g/5 N	\$4.95
SB24748	1000 g/10 N	\$4.95
SB24749	2000 g/20 N	\$4.95
SB16478	3000 g/30 N	\$4.95
SB16479	5000 g/50 N	\$4.95
SB42821	10,000 g/100 N	\$4.95

GET EXACT MEASUREMENTS for a variety of objects



Aluminum Spring Scales

Anodized aluminum with steel hooks. Hook at top allows for easy attachment to support rods.

Product No.	Capacity	Graduation	Color	Each
SB53244	100 g/1 N	2 g/0.02 N	Black	\$6.15
SB53245	250 g/2.5 N	5 g/0.05 N	Blue	\$6.15
SB53247	1,000 g/10 N	20 g/0.2 N	Brown	\$6.15
SB53248	2,000 g/20 N	40 g/0.4 N	Red	\$6.15
SB53249	3,000 g/30 N	50 g/0.5 N	Silver	\$6.15
SB53250	5,000 g/50 N	100 g/1 N	Gold	\$6.95

Spring Scales

Metal case, pointer, spring, suspension ring, and load hook. Calibrated in both Newtons and grams, with zero adjustment.

Product No.	Capacity & Readability	Each
SB25288	0-100 g/1 N	\$5.95
SB25289	0-250 g/2.5 N	\$5.95
SB25290	0-500 g/5 N	\$5.95
SB25291	0-1000 g/10 N	\$5.95
SB25292	0-2000 g/20 N	\$5.95
SB25294	0-5000 g/50 N	\$5.95

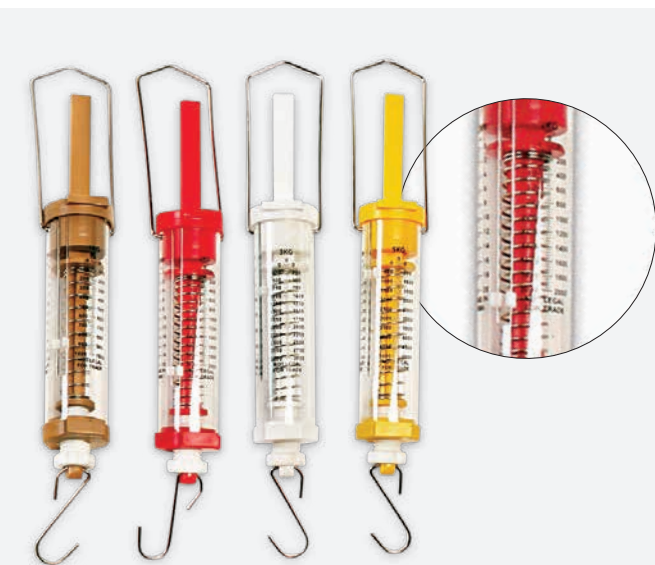

Memory Force Meters

Measures force by pushing or pulling an object. Calibrated in both Newtons and grams. Clear plastic tube allows students to see the action of the spring. Includes activity guide.

Product No.	Capacity	Color	Each
SB50546	1,000 g/10 N	Beige	\$6.95
SB50547	2,000 g/20 N	Red	\$6.95
SB50542	5,000 g/50 N	Yellow	\$6.95



A. Hooked Weight Set of 9

Cast-iron weights with black enamel finish. One each of 10 g, 50 g, 100 g, 500 g, 1,000 g, and 2 each of 20 g and 200 g weights. **SB37395 – \$48.50**



B. Stainless Steel Hooked Weight Set of 10

Set of 10 weights includes one each of 5 g, 10 g, 50 g, 100 g, 500g, and 1,000 g weights and two each of 20 g and 200 g. Includes plastic storage block. **SB47084 – \$129.95**



C. 8-Piece Mass Set Replacement

Includes 1 each of 1 g, 10 g, 20 g, and 50 g weights; and 2 each of 2 g and 5 g weights. **SA05380 – \$13.95**

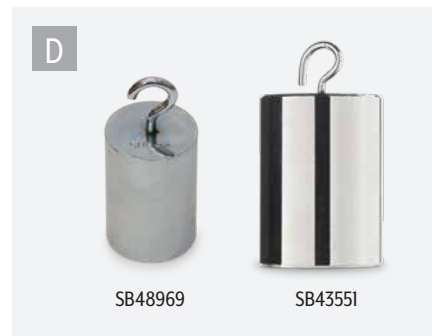

D. Hooked Weights

Nickel-plated steel weights are engraved on surface and feature a hook at one end. **500 g. CHOKING HAZARD (I). Not for under 3 yrs. SB48969 – \$13.95**



E. Basic Hooked Weight Set

Stainless steel. Set of 10 includes four 20 g, three 50 g, two 100 g, and one 200 g weights. **SB49818 – \$48.75**



F. Aluminum Hooked Mass Set

Plastic base. Includes two each of 10 g and 20 g and one each of 50 g and 100 g weights. **SB37270 – \$14.95**

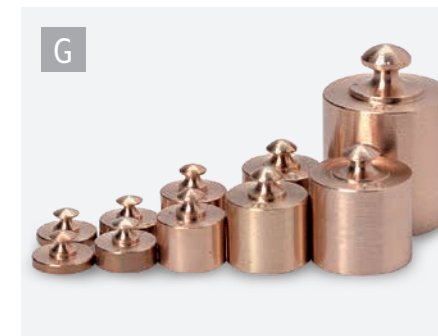

G. Brass Mass Set of 10

Set includes two each of 1 g, 2 g, 5 g, and 10 g and one each of 20 g, and 50 g. **CHOKING HAZARD (I). Not for under 3 yrs. SB37228 – \$16.50**

Protractors
6". Plastic. Four assorted colors. Pkg. of 24.
TB16685 — \$9.25

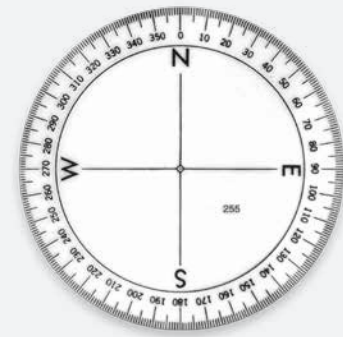
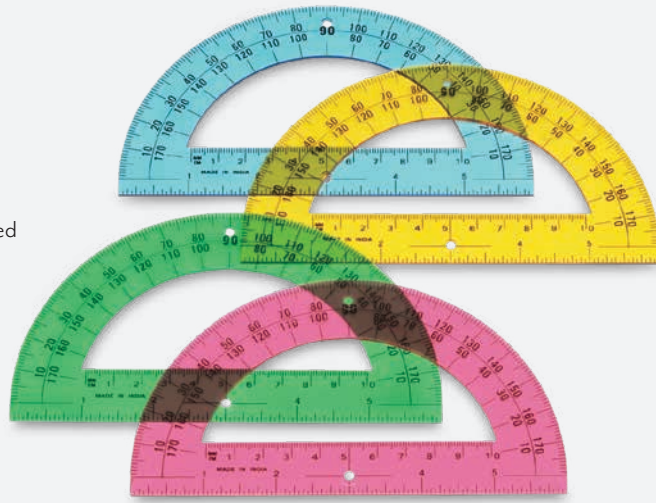

C-Thru® 360° Clear Protractor
Calibrated in degrees. Laminated with solid center. 3½".
SB27450 — \$1.95



Trundle Wheel
Roll wheel forward or backward to produce a loud "click" every meter. 1 m wheel circumference. Wheel edge grips smooth surfaces and is calibrated in cm (numbered in cm every dm). Plastic with molded, collapsible handle. Use indoors or out. ⚠️ CHOKING HAZARD (1). Not for under 3 yrs.
TA05347 — \$13.50

BEST SELLER

Shatterproof ruler is ideal for constant classroom use



12" Clearview Ruler
12"/30 cm ruler is scaled 1/16" on one edge and mm and cm on the other.
TB23369 — \$0.55

BEST SELLER

SAFE-T® Compass
Draw circles from ¼" to 10" in diameter in 1/16" radius increments. No sharp point. Made of shatter-resistant plastic. Two mini-rulers (inches and metric).
9704224 — \$1.95
Classroom Pack of 30
TB17429 — \$52.55



Retractable Tape Measure
60" on one side, 150 cm on the other. Locks and holds in position, lies flat, doesn't curl, and is flexible. Virtually indestructible. 5/16".
TB15105 — \$0.95

A. Clearview Flexible Rulers
Made of shatter-resistant material. Pack of 12 includes two 12" rulers each of 6 colors.
TB23368 — \$8.95

B. 30 cm Clearview Ruler
Clear ruler has mm on one side and cm on other side.
SB35027 — \$1.00

C. 30 cm Senior Ruler
Both edges calibrated in mm. One edge numbered in cm; other in mm. Plastic.
SB30240 — \$1.20

Metersticks
Hardwood, clear varnished, with black markings. One side scaled in mm, with cm and dm numbered. Reverse side is graduated in inches with 1/8" divisions.

D. Half Meter Plain Ends. 50 cm in length.
SB12163 — \$4.50

E. Metal Ends
SB12161 — \$4.95

F. Plain Ends
TB24794 — \$2.85

G. Senior Meter Stick. One side is calibrated in 0.5 cm and numbered each cm. Reverse side is calibrated in mm.
SB52796 — \$3.95

H. Hardwood Meterstick
1" x 5/16" thick.
SB47938 — \$3.25

I. Customary/Metric Tape Measures
Inches on one side and cm and mm on the reverse. Pkg. of 10; 60". Assorted colors. Plastic.
TB15183 — \$5.95

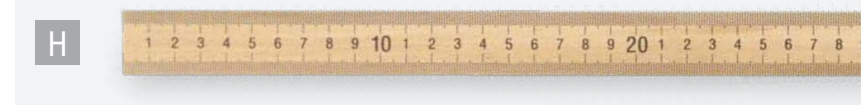

Windup Meter Tapes
Virtually indestructible, high-quality fiberglass tapes in ABS plastic windup cases. Calibrated on one side in 0.5 cm and inches on the other. Will not tear, break, rust, or stretch.
SB33643 10 m — \$6.95
SB33641 30 m — \$8.95
SB33642 50 m — \$15.95



Vernier Caliper
A steel double-scale caliper with adjustment roller and locking screw. 120 mm x 0.1 mm and 5" x 1". Margin of error: ± .5 mm.
SB27537 — \$6.95



EXCLUDED FROM DISCOUNTS

TI-84 CE Python Graphing Calculator
Give students the power of portable programming for math class and other applications. This lightweight and durable calculator features a color screen, an easy-to-read display, and a rechargeable battery. It has eight different graph styles and can save up to 10 graphing functions. Real and complex numbers can be calculated to 14-digit accuracy and displayed with 10 digits plus a two-digit exponent. USB cable and protective case included.

NE30224 — \$175.00

TI-84 Plus CE Python EZ Spot Teacher Pack. 10 EZ Spot units and rechargeable batteries, 5 USB cables, 5 unit-to-unit cables, TI charging station CE, and poster.
NA10409 — \$1,805.05

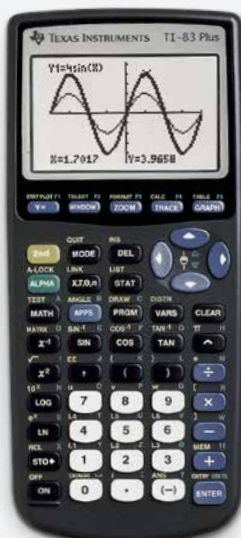

EXCLUDED FROM DISCOUNTS

TI-83 Plus Graphing Calculator

- Functions for algebra, calculus, and science applications
- Equation solver editor solves for different variables interactively
- Applications can be installed for customization
- Works with CBL™ System and CBR™ for analysis of real-world data
- Link cable (included) allows data sharing with another TI-83 Plus, TI-82, or TI-83
- 7 different graphing styles
- Slide-on hard case
- Requires 4 "AAA" batteries (included)

NA10404 — \$131.20

Teacher Kit. 10 TI-83 Plus calculators.
NA10405 — \$1,312.00

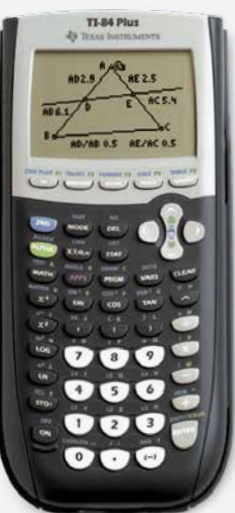

EXCLUDED FROM DISCOUNTS

TI-84 Plus Graphing Calculator

- Connectivity to existing TI ViewScreen™ panel and TI-Presenter™ video interface, allowing students to show work to the entire class
- Built-in USB port with cable (included)
- Preloaded handheld software applications
- High-contrast display
- Fully compatible with CBR™, CBL™, and CBL2™ data collection systems; TI keyboard; and TI-Navigator™ Classroom Learning System
- Requires 4 "AAA" batteries (not included)

NA10406 — \$139.95

EZ Spot Teacher Kit. 10 TI-84 Plus EZ Spot calculators.
NA10407 — \$1,350.00

BEST SELLER

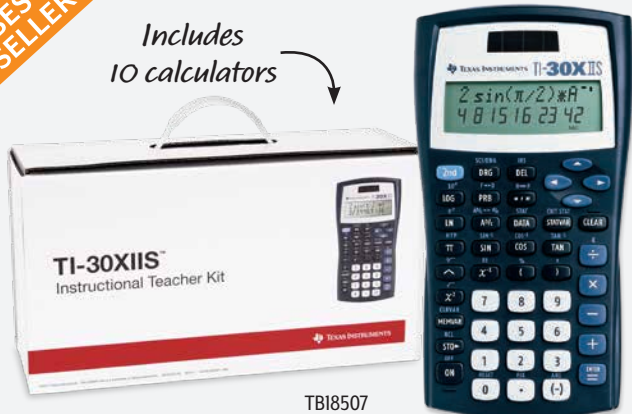

Includes 10 calculators

TB18507

TI-30X IIS Calculator

- View entry and result at same time
- Edit current entry
- Menus with functions and mode setting
- 5 variable memories
- 1- and 2-variable statistics include results for linear regression and trendline analysis
- Enter/delete/insert/edit individual statistical data elements
- Trigonometric functions in degrees and radians
- Common and natural logarithms
- Fractions and fraction/decimal conversions
- Degrees, minutes, seconds/decimal degrees conversions

TB18506 — \$20.00

Teacher Kit. 10 calculators, poster, teacher's guide, and carrying case.
TB18507 — \$185.00



TI-1706V Solar Power Calculator

- 8-digit display
- 3-key memory
- Change sign (+/-) and square root keys
- ANYLITE solar power allows operation even in low light
- Protective slide case

TB17148 — \$9.95

Nasco Primary Calculator

Features the 4 main functions, three-key memory, and auto power-off. Solar and battery powered. Δ CHOKING HAZARD (I). Not for under 3 yrs.

TB23305 — \$3.95

TI-108 Solar Calculator

Features percent key and sign key (+/-). Protective slide case. Solar and battery powered. $4\frac{1}{2}'' \times 2\frac{3}{8}'' \times 4''$.

TB14985 — \$7.95

Teacher Kit. 10 calculators in cardboard storage box with string handle, poster, transparency, and teacher's guide on CD.
TB17145 — \$69.95

Classroom Set. 30 calculators, 3 posters, 3 teacher's guides on CD, and 3 cardboard storage boxes with string handle.
TB17146 — \$210.00

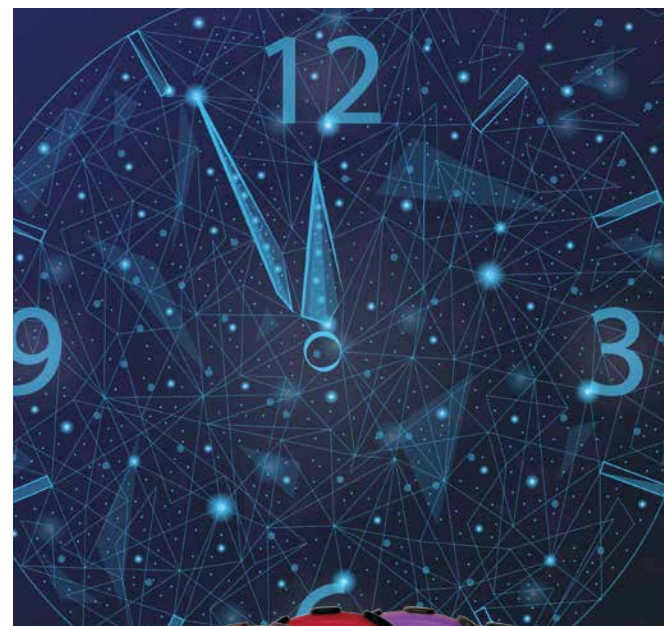

MyChron™ Student Timers

Three-key operation (Lap, Start/Stop, Reset); clear display of hours, minutes, seconds, hundredths/seconds; auto shutoff; and hole for attaching to hanging cord. Magnetic strip, spring clip, belt clip, magnet, easel back, and storage box.

TB17781 Set of 6 — \$66.95

TB17891 Set of 12 — \$132.95



Accusplit® Survivor II Stopwatch Set of 6

Features cumulative split timing, 1-2 fast finish, event time-in and time-out, and magnum XL display. Timing range: 30 minutes to $\frac{1}{100}$ of a second, 24 hours to 1 second. Water-resistant to 100 ft./30 m. Breakaway lanyard.

PE03203 — \$69.95



Ultrak® 310 Timer Set of 6

Features start/stop and reset. Measures up to 10 hours. Includes 1 each of 6 colors with lanyards.

PE06883 — \$58.95



Dual Power Timers

Time up or down to 99 minutes and 59 seconds. Alarm sounds when time has been reached. Solar panel and internal battery. Display size: $2\frac{1}{16}'' \times 1''$. Overall size: $2\frac{3}{16}'' \times 2\frac{3}{16}'' \times \frac{1}{2}''$. Pkg. of 5.
TB26740 — \$34.95

BEST SELLER



All-Purpose Digital Stopwatch

Hour, minute, and seconds display; calendar display; 24-hour stopwatch; alarm; hourly chime; 12/24-hour mode option; $\frac{1}{1000}$ -second chronograph; split time; and total time. Carrying cord. Color and style may vary.

TB14784 — \$3.95

SB51407 Set of 12 — \$35.00

EZY Timer

Digital timer with three-button operation. Display shows time in hours, minutes, seconds, and hundredths/seconds. Magnetic back clip. Top right corner features a hole for hanging cord (not included).

TB26033 Set of 6 — \$47.00

TB26034 Set of 12 — \$87.00



Clip-On Timer with Magnetic Clip

Counts down or up. Times up to 99 minutes 59 seconds. 60-second alarm. Magnetic back clip holds to metal surfaces and converts to stand. Requires 1 "AAA" battery (not included). Δ CHOKING HAZARD (I). Not for under 3 yrs.

TB16742 — \$7.95



Nasco Individual Student Dry-Erase Board Kit

Low-tech solution for high-tech learning. Give each student one of these dry-erase board kits so they don't have to share with their classmates. Perfect for working out a math problem or recording an answer to show to the teacher via a Zoom class. Kit includes 9" x 12" dry erase board, black dry erase marker, mini eraser, and zippered plastic bag. **NE30026 – \$4.95**

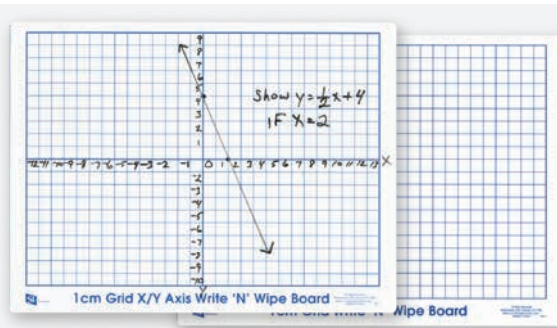

TB20770 TB20771

Write 'N' Wipe Board Class Sets

Two-sided, no-tear, plastic boards for use with dry- or wet-erase markers. Blank on one side and available with x- and y-axes or 1 cm grid on other side. Sets of 30; 9" x 12" each. **TB20770** X- & Y-axes **TB20771** 1 cm grid **Each – \$34.95**

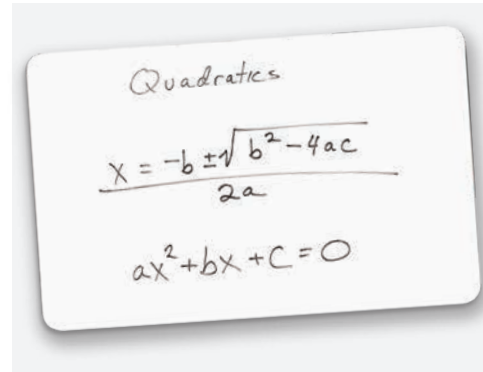

Single-Sided Unlined Dry-Erase Board

Blank board is ideal for various activities. 12" x 18". **SB36895 – \$4.95**



Nasco Cone-Point Dry-Erase Markers – Black

Long-lasting, ultra low-odor, cone-tip dry-erase markers. Box of 30. **TB21488 – \$26.80**

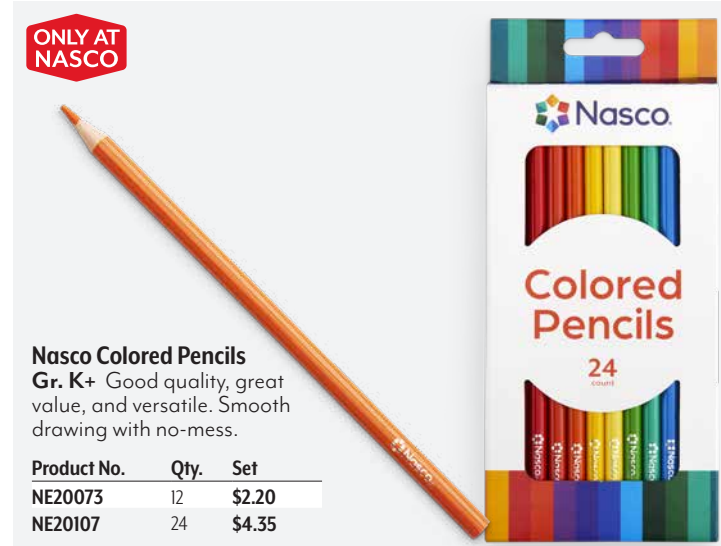

ONLY AT NASCO

Nasco Colored Pencils

Gr. K+ Good quality, great value, and versatile. Smooth drawing with no-mess.

Product No.	Qty.	Set
NE20073	12	\$2.20
NE20107	24	\$4.35



Sharpie® Ultra-Fine Point Markers

The permanent marker for precise, detailed marking. Water- and fade-resistant ink. Use on wood, plastic, glass, and metal. Quick drying. Box of 12. Black. Nontoxic. **9717998(A) – \$14.50 24+ \$12.15**

Sharpie® Fine-Point Markers

The original pen-style permanent marker. Fade- and water-resistant. Permanent on most surfaces. Quick drying. Box of 12. Black. Nontoxic. **9717997(A) – \$14.50**



Nasco No. 2 Pencils - Sharpened Pkg. of 144

Now you can afford to supply all your students with this economical box of 144 standard pencils. Sharpened pencils are certified nontoxic and feature a quality #2 writing core and latex-free eraser. **NE20211 – \$22.35**



Fine Point Industrial Markers

For industrial and laboratory use. Resists bleeding and fading when exposed to extreme heat and steam (up to 500° F), processing chemicals and cleaners, and ultra-violet light. Use on glass, metal, plastic, and wood. Black. **9720900 – \$2.30 12+ \$2.10**

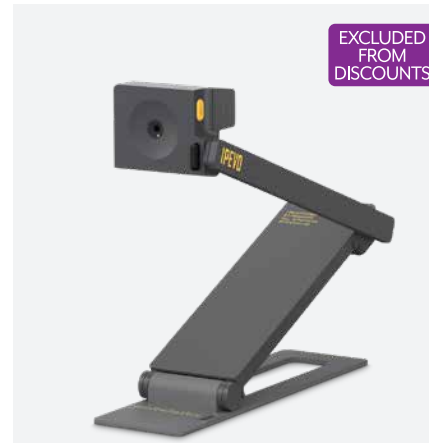

EXCLUDED FROM DISCOUNTS

IPEVO DO-CAM USB Document Camera

It just takes a flip of the camera head to switch from doc cam to webcam! 8MP CMOS sensor can stream up to 30 fps at 1080p. Integrated USB Type-A cable connects the camera to your Mac, Windows, or Chrome computer. Ultra-portable at only 0.74 lb. No built-in microphone. **NE30413 – \$129.00**

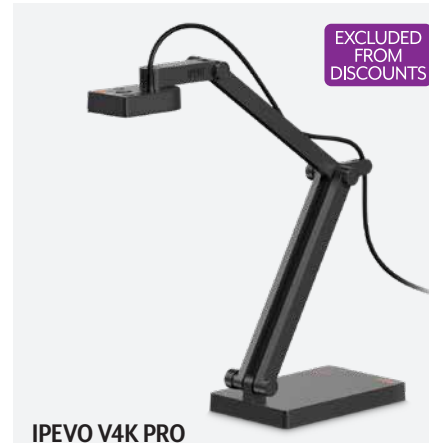

EXCLUDED FROM DISCOUNTS

IPEVO V4K PRO Ultra HD USB Document Camera

Advanced noise filter is highly effective at removing background sounds while maintaining the natural sound of your voice. 8MP CMOS sensor can stream at up to 30 fps at 3264 x 2448p. Integrated USB Type-A cable connects the camera to your Mac, Windows, or Chrome computer. Built-in microphone, LED, and fast focusing speed. **NE30412 – \$149.00**

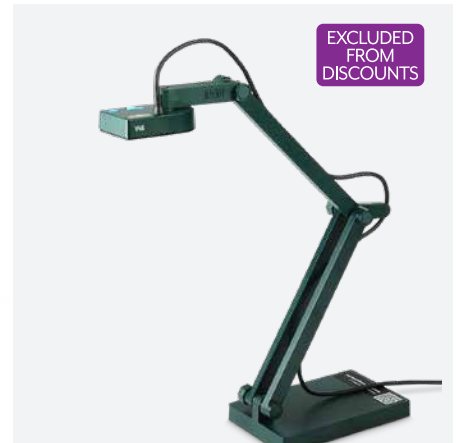

EXCLUDED FROM DISCOUNTS

IPEVO V4K Ultra HD USB Document Camera

Livestream presentations and scan documents in high resolution. 8MP CMOS sensor can stream at 30 fps when in Full HD. Integrated USB Type-A cable connects the camera to your Mac, Windows, or Chrome computer. Built-in microphone and fast focusing speed. **NE30411 – \$101.00**

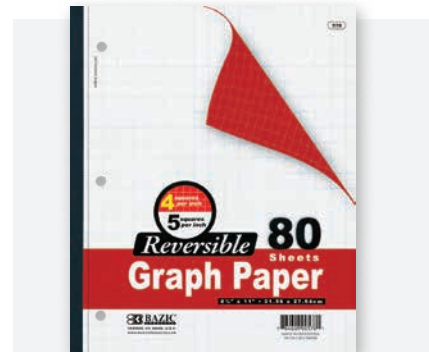

Reversible Quad-Ruled Wireless Notebook

4x4 squares per inch on front and 5x5 squares per inch on reverse. 80 sheets, 8½" x 11". Assorted colors (no choice). **TB26495 – \$3.20 12+ \$2.46**

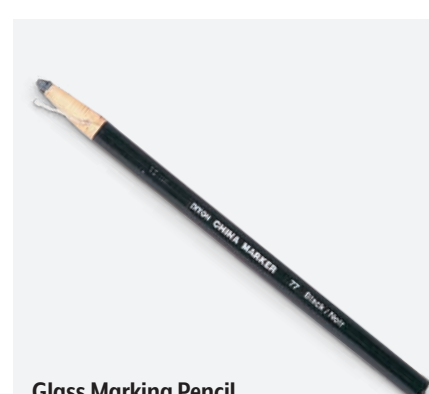

Glass Marking Pencil

Paper covered, self sharpening with pull string. Writes on all types of surfaces. Water-resistant, colorfast marks still remove from nonporous finishes. Pkg. of 12. **9701022 – \$11.95**



Luna 2 Interactive Projection Camera

All-in-one projection tool, webcam, and photo/video camera. USB connection for computer or whiteboard. Capture photos or video and download. Features 3.0 MP images. **CHOKING HAZARD (1)**. Not for under 3 yrs. **TB26743 – \$150.00**

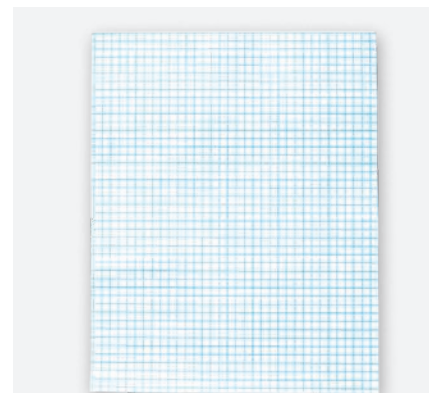

Graph Paper

Increments are already perfectly spaced. Pad of 50 sheets, 8½" x 11". **9706099 – \$2.25**



Copernicus® DEWEY – The Document Camera Stand

Turn your iPad® into a document camera. Share work, ideas, and inspiration. Height-adjustable stand with 90° rotating mount that swivels and tilts. Headphone holder and mounting holes on base for security. Fits iPad® 2, 3, 4, Air, Air 2, Mini, Mini 2, and Mini 3, plus various smartphones with or without a case. Frame is 10¾" x 15" x 12¾"-23". Lifetime warranty. **TB26685 – \$89.95**

Copernicus® Camera Stand with Microscope & LED Light. Microscope feature with 5X or 10X magnification and adjustable LED light. Lifetime warranty. **EL14305 – \$104.95**

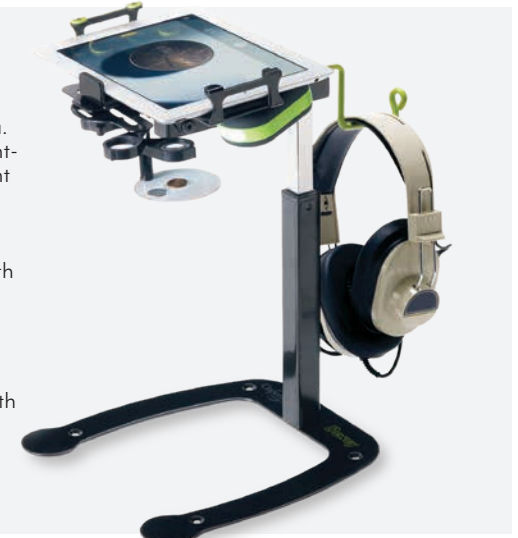

Shatterproof



12" L

General Purpose Nonstick Coated Thermometers

Nonstick sleeve remains intact. Filled with blue column of organic liquid on bright yellow background. Yellow back glass with silk screen printed blue scales. Reverse side indicates immersion. Indelible and resistant to aggressive chemical agents. Triangular ring top prevents rolling. 1° C divisions. 12" L.

Product No.	Range °C	Immersion	Each
SB33542	-20° to 110°	Total	\$17.95
SB33545	-20° to 150°	Partial	\$19.95



12" L

Enviro-Safe® General Laboratory Thermometers

Filled with safe, biodegradable, nontoxic liquid dye. Biodegradable and environmentally friendly. Calibrated with NIST (NBS) standards. Envirokleen certification. 12" L.

Product No.	Range Low High	Scale	Division	Immersion	Each
SB23911	-20° to 110°	C	1°	Total	\$14.95
SB23912	-20° to 110°	C	1°	Partial (76 mm)	\$14.95
SB23916	-10° to 260°	C	1°	Partial (76 mm)	\$15.95

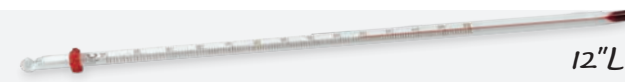

12" L

General Laboratory Red Liquid Thermometers

Use in all general lab applications including hot ovens and incubators. 12" L. **CHOKING HAZARD (I).** Not for under 3 yrs.

Single Scale

Product No.	Range Low High	Scale	Subdivision	Back	Immersion	Each
SBI4147	-20° to 110°	C	1°	White	Partial (76 mm)	\$4.25
SBI4148	-20° to 110°	C	1°	White	Total	\$3.95
SBI4149	-20° to 150°	C	1°	White	Partial (76 mm)	\$3.95
SBI5198	-20° to 150°	C	1°	White	Total	\$3.95



12" L

Double Scale

Product No.	Range Low High	Scale	Subdivision	Back	Immersion	Each
SBI5197	0° to 230° -20° to 110°	F C	1° 2°	White	Partial (76 mm)	\$3.95
SBI4150	0° to 230° -20° to 110°	F C	1°	White	Total	\$3.95

◆ Hazardous material



6" L

Student Thermometer

6" L. Filled with safe red liquid. Total immersion. Non-roll sleeve.

Range: 0° to 220° F/-10° to +110° C. Range: -10° to +110° C. Single scale. Dual scale. 2° subdivision for F; 2° subdivision. 1° for C.

◆ SBI9157 – \$5.95

◆ Hazardous material



Thermometer Storage Rack (25 Total)

Polypropylene with sturdy base and large handles. Hole diameters in top and middle plates are 5/16"; base plate drain holes are 1/8".

SB25042 – \$46.95



Thermometer Holder

Molded polypropylene holder clips onto edge of beaker or other vessel to hold thermometer vertically near side of container. Thermometer is held in a hole with small fingers that expand. Holds any thermometer from 1/8" to 7/16" (3.2–11 mm) in diameter. Autoclavable at 121° C (250° F). Bag of 3. SB25150 – \$22.95



NeuLog Wide Range Temperature Logger Sensor

This sensor is based on a thermocouple sensor that enables measuring very high temperature levels, even the temperature of a flame, as well as very low temperature levels. Measures both Celsius (-200° to 1200° C) and Fahrenheit (-328° to 2200° F). Accommodates experiments lasting from 1 second to 31 days. Features 10 bit ADC resolution, resolution of 0.1° F (0.1° C), and a maximum sample rate of 100 S/sec. NOTE: Requires either Wireless Module (SB50671) or USB Module (SB50672) to operate (both sold separately at nascoeducation.com).

SB51902 – \$85.00

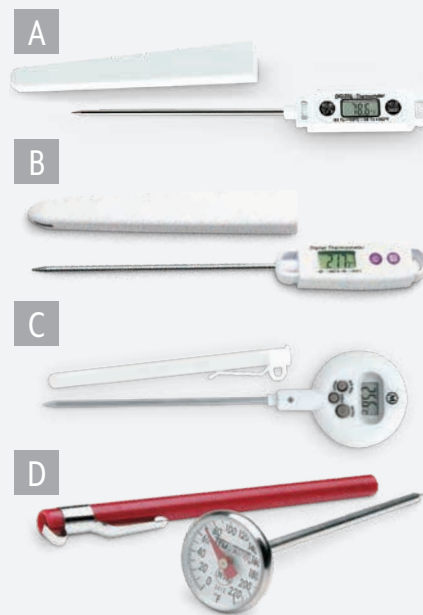

A. Digital Thermometer

On/off switch, stainless steel probe, and probe cover. Switch from °C to °F. Waterproof. Range: -58° to 302° F (50° to 150° C). SB33569 – \$20.95

B. Digital Thermometer

Use with liquids, semi-solids, and gases. Maximum/minimum memory. Data hold. 5" stainless steel probe reaches easily into cuvettes, test tubes, flasks, and more. Temperature range: -58° to 392° F (-50° to 200° C) with accuracy of ±1° C from -20° C to 120° C; otherwise ±2° C. Calibrated at 0° C and 100° C. Resolution: 0.1 °F/°C. 7 7/8" x 1". CE marked. SB47505 – \$64.95

C. Pen-Shape Digital Thermometer with Min./Max. Memories

Extra-wide temperature gauge, 14° to 410° F (-10° to 210° C). Min./max. memory. Heat-resistant 4" stainless steel probe. Probe cover with pocket clip. Colors may vary. SB39069 – \$19.95

D. Instant-Read Dial Thermometer

Accurate from 0° to 220° F. Shatterproof plastic lens. Pocket case. Stainless steel stem. SB39402 – \$3.95



Digital Thermometer

Easy-to-read 0.3" LCD readout. High temp range from -58° to 500° F (-50° to 260° C). Stainless-steel stem. Pocket sleeve. NSF® certified. SB33552 – \$21.95

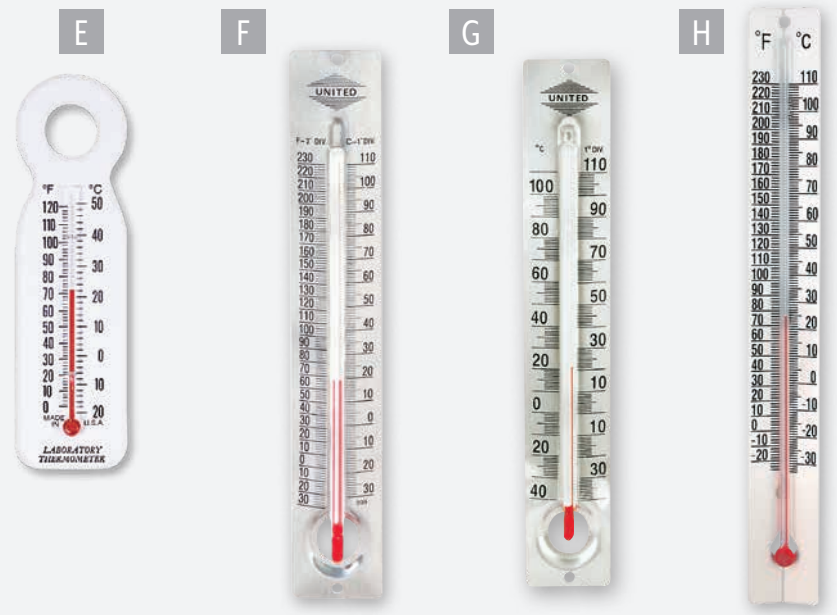

E. F°/C° Student Thermometers

Large, easy-to-read markings for 0° to 120° F (-20° to 50° C). White polystyrene backing. 6 1/4" L. Filled with red liquid. Pkg. of 10. TBI9654 – \$9.15

F. Student Thermometer

Temperature range: -30° to 230° F (-30° to 110° C). SB33327 – \$3.95
SB47751 Set of 5 – \$16.95

G. Celsius Classroom Lab Thermometers

Metal-backed, with -30° to 110° C scale with 1° and 5° divisions. Large, easy-to-read numbers. 5" red liquid-type tube. 6 1/2" L. Pkg. of 5. SA08157 – \$7.95

H. C°/F° Classroom Thermometers

Metal. Celsius scale in 1° divisions, Fahrenheit in 2° divisions. 5" red liquid-type tube. Aluminum back. 6 1/2" L. Range: -20° to 230° F (-30° to 110° C). V-shaped. Set of 5. SB47135 – \$9.95

PocketLab Thermo

Gr. 6+ Let this simplified two-temperature probe turn your next science lesson into an exploration. Wireless, multi-functional and remote-ready. Thermo is a dual temperature sensor that includes two thermistor probes with simultaneous measurement capabilities. Compare any two temperatures — any time, anywhere. 4 3/4" x 3 1/2" x 1 1/4". NE30107 – \$49.95

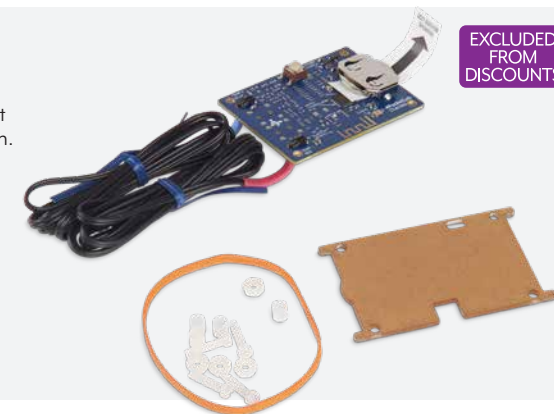

EXCLUDED FROM DISCOUNTS

Boiling Point Thermometer Set

Gr. 3+ Nontoxic thermometers measure from -22° to 240° F (-30° to 120° C). Plastic. Mercury free. Set of 10 in reusable storage box. SB42013 – \$23.95



SAFETY AND IMPACT GOGGLES

Designed to protect your eyes from flying objects

SPLASH GOGGLES

Designed to protect your eyes from chemical splashes

BEST SELLER



UV Sanitization Cabinets

Sanitize goggles, supplies, lab equipment, or other shared materials quickly and safely. These cabinets are simple to operate and efficiently disinfects everything of germs, bacteria, viruses, and fungi. Powered by a UV-C lamp to kill germs.

NE30051 Large Cabinet, holds 35 pairs — **\$725.00**
NE30208 Small Cabinet, holds 20 pairs — **\$475.00**

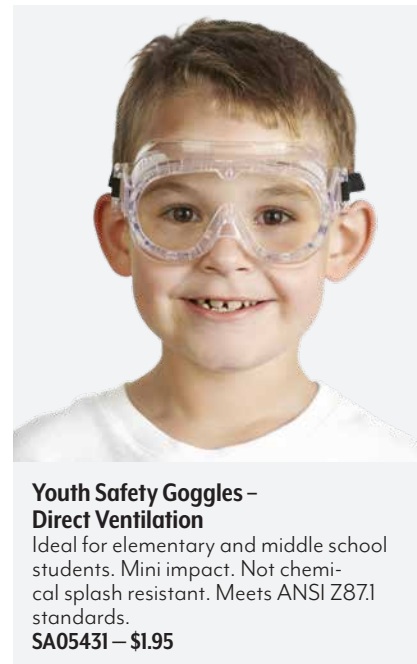
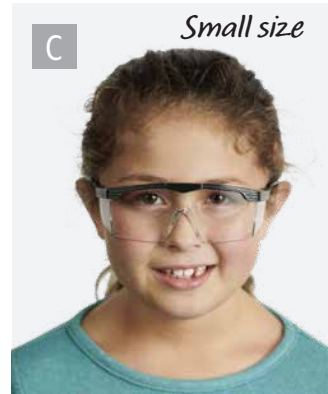

Youth Safety Goggles – Direct Ventilation

Ideal for elementary and middle school students. Mini impact. Not chemical splash resistant. Meets ANSI Z87.1 standards.
SA05431 — **\$1.95**



Safety protection from impact

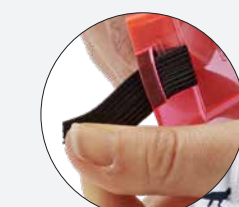

Youth Safety and Splash Goggles-Indirect Ventilation

Clear flexible vinyl body. Clear uncoated polycarbonate lens. 15% smaller than standard safety eyewear. Meets ANSI Z87.1 high impact standards.
SB46780 — **\$3.95**

A. Safety Glasses
 Wide, one-piece lens. Adjustable temples. Polycarbonate. Meets ANSI Z87.1 high impact standards.
SB32854 Blue Frame
SB39510 Black Frame
 Each — **\$3.95**

B. Visitor's Glasses
 Meets most semi-hazardous conditions. Can be worn over glasses. Wraparound side shields. Meets ANSI Z87.1 standards.
SB16273 — **\$4.25**

C. Small Size Safety Glasses
 Black or blue frame (color varies). Wide, one-piece lens. Adjustable temples. Polycarbonate. Meets ANSI Z87.1 high impact standards.
SB39512 — **\$3.65**

D. Visorgog Economy Safety Goggles
 Fits over glasses. Clear frames and lenses. Meets ANSI Z87.1 high-impact standards.
SB46877 — **\$11.25**

E. Chemical Splash Goggles – Indirect Ventilation
 Scratch-resistant, UV-absorbing polycarbonate. Adjustable strap fits over prescription eyewear. Indirect ventilation. Meets ANSI Z87.1-2003 standards as well as ANSI+ high impact standards.
SB47688 — **\$17.95**

F. Safety Goggles – Direct Ventilation
 One-piece polycarbonate lens. Perforated frame for full direct ventilation. Meets ANSI Z87.1 standards.
SB25323 — **\$2.45**

G. Chemical Splash Goggles – Indirect Ventilation
 High-quality PVC frame. Polycarbonate lens. Meets ANSI Z87.1 standards.
SB06969 — **\$9.95**

H. Chemical Splash Goggles – Indirect Ventilation
 High-quality PVC frame. Polycarbonate lens. Meets ANSI Z87.1 standards. Light blue or light green tint.
SB25324 — **\$2.95**

I. Softsides™ Safety Goggles – Indirect Ventilation
 Soft vinyl body molds snugly to face. Fits comfortably over most prescription glasses. Extended face flanges close gaps over nose and cheekbone areas for better protection. Scratch-resistant, FogLess™ coating front and back. Clear blue transparent frame prevents yellowing. Meets ANSI Z87.1.
SB50521 — **\$6.95**

Powder-free

A. Gold Latex Powder-Free Exam Gloves

Minimum risk of potential glove-related chemical or protein allergies. Made with light chlorination rinse. Nonslip, tacky surface provides excellent grip for dry and wet applications. Box of 100 for medium and large; box of 90 for X-large. 4 mil.

C31908 Medium **C31909** Large **C31910** X-Large
Each — \$16.95

B. Nitrile Gloves

Ultra soft and super stretchy. Reduces hand fatigue. Textured surface. Thinner for maximum dexterity. Superior barrier protection. 100% synthetic. Box of 100 for sizes X-small, small, medium, and large; box of 90 for size X-large. 4 mil.

SB48872 Small **SB48874** Large **SB48875** X-Large
SB48873 Medium
Each — \$24.95

C. Black Nitrile Gloves

Ultra soft and super flexible. Simulates fit and feel of latex gloves. Masks stains, inks, dyes, and grease while allowing quick identification of light-colored substances. Finger thickness: 4.3 mm. Box of 100.

SB49978 Small **SB49980** Large
SB49979 Medium **SB49981** X-Large
Each — \$24.95

D. Blue Nitrile Gloves

100% synthetic nitrile polymer gloves are odor free. Thermal sensitive, polymer compound absorbs body heat and conforms to user's hands and exerts virtually no pressure on hands. 5 mil. Box of 100 for sizes small, medium, and large; box of 90 for size X-large.

C20030 Small **C20032** Large
C20031 Medium **C20033** X-Large
Box — \$19.95



Powdered

E. Latex Gloves

Natural rubber latex disposable gloves stretch and flex for comfortable fit. Provides dexterity and tactile sensitivity. Powdered with edible corn starch. Box of 100. 5 mil.

SB48876 Small **SB48877** Medium **SB48878** Large
Each — \$13.95



Economical

F. Low Density Polyethylene Gloves — Powder Free

Are ideal for lab work in biology and chemistry. Dispenser box of 100. 1½ mil.

SB48963 Small **2100320** Medium **2100321** Large
Each — \$4.95



G. Vinyl Powder-Free Gloves

Made from a special synthetic component and soft PVC material. Soft like premium leather. More elastic to fit snugly and comfortably. 4 mil. Box of 100 for sizes small, medium, and large; box of 90 for size X-large.

SB50313 Small **C31841** Large
C31840 Medium **C31842** X-Large
Each — \$12.95



Combine chemistry and art to create tie-dye lab aprons that pop with color



All-Purpose Disposable Aprons

Tough, smooth white aprons of 1.75-mil polyethylene are liquid-proof. Covers most people below the knee. Plastic ties and neck-line band fit comfortably. 28" x 45". 100 aprons per dispenser box. 5 dispenser boxes per case.

W05863
Box of 100 — \$24.95
W05864
Case of 500 — \$114.95

Knee-Length Lab Coats

Made of 65% Dacron® and 35% finely combed cotton. Lapel collar; double-thickness cuffs; adjustable belt in back; upper left pencil-seamed breast pocket; two deep lower pockets; side slit openings; and buttons. Fabric U.S.A.

H. Men
SB08098 Medium (40)
SB08099 Large (44)
SB08100 X-Large (48)
Each — \$24.95

I. Women
SB10912 Small (34)
SB10913 Medium (40)
SB10914 Large (42)
Each — \$33.00

J. Unisex Lab Coats

Soft poplin fabric coats with high cotton content for more breathability and moisture absorption. 80% polyester/20% cotton.

SB47454 X-Small — \$22.95 **SB47458** X-Large — \$23.95
SB47455 Small — \$22.95 **SB47459** 2X-Large — \$23.95
SB47456 Medium — \$22.95 **SB47640** 3X-Large — \$25.95
SB47457 Large — \$22.95

K. Translucent Lab Aprons

6-mil thick plastic. Resistant to lab chemicals, acids, bases, oil, and grease. Ties at waist and neck are reinforced with cloth tape.

Child's Size 30"L x 24"W
SB37255 — \$6.95 **42"L x 27"W**
36"L x 27"W **SB37256** — \$6.95
SB37257 — \$7.95 **46"L x 36"W**
SB37258 — \$7.95

L. Rubberized Laboratory Aprons

Chemical-resistant, flexible, and lightweight.

Child's Size. 30"L x 24"W **36"L x 27"W**
SB37271 — \$7.95 **SB37272** — \$8.95
42"L x 27"W **42"L x 36"W**
SB37273 — \$9.95 **SB37274** — \$10.95

M. Disposable Knee-Length Lab Coats

White, 44" splash- and spray-resistant lab coats feature three pockets (one upper and two lower front), heavy-duty snaps, cuffs, and latex-free construction.

SB47104 Medium
SB47105 Large
Each — \$2.95

N. Youth Lab Apron Tie-Dye Kit

Students learn the simple concepts of the tie-dye process and the chemical reactions involved (solubility, color mixing, and the movement of molecules). Includes 30 lab aprons, needed materials, and instructions. ⚠️ CHOKING HAZARD (I). Not for under 3 yrs.

SB48484 — \$174.95

Youth Lab Apron Only. No pockets. 24" x 30". White.
SB48483 — \$4.95

Face Shield

Get full-face splash protection while still allowing students to see all of you with this lightweight, anti-fog face shield. Soft elastic, padded headband offers all-day comfortable wear, and clear polyethylene construction makes it affordable enough to be disposable. Can also be sanitized for even more economical reuse. **NE30025 – \$2.95**



Adult 3-Ply Disposable Face Mask

Protect students and staff with these disposable, non-medical face masks for use in a simulated medical environment. Convenient behind-the-ear straps and adjustable nose wire (bridge clip) for comfort. Pack of 50. **NE30024 – \$14.95**



First Aid Kit

Ideal for home, office, and vehicles. Contains 88 first aid items. Go to nascoeducation.com for a complete list of contents. **C29348 – \$22.69**



First Aid Kit

For any place with up to 25 people. Balanced assortment of supplies.

Contents:

- CPR mask, 2 gloves, and 2 alcohol prep pads per unit box
- 4 vinyl gloves, large
- 12 alcohol prep pads, sterile
- 15 BZK antiseptic wipes
- 2 iodine antiseptic wipes
- 3 Soothe-A-Sting™ wipes
- 6 burn cream packets
- 6 triple antibiotic packets
- 32 woven bandages (1" x 3")
- 10 juniors bandages (3/8" x 1 1/2")
- 1 stretch gauze bandage (2")
- 1 stretch gauze bandage (4")
- 1 triangle bandage with pins
- 2 sterile pads (2" x 2")
- 6 sterile pads (4" x 4")
- 1 ABD pad (5" x 9")
- 1 waterproof tape (1" x 2 1/2")
- 2 eye pads
- 1 eye wash (1/2 oz.)
- 3 sterile cotton-tip applicators
- 2 tongue blades
- 1 cold pack
- 1 pair of scissors
- 1 pair of forceps
- 1 first aid manual

Packaged in a weatherproof plastic case with wall-mounting handle/hanger. Complies with OSHA requirements. Contents meet ANSI Z308.12009.

◆ **SBI3977 – \$39.95**



Portable Eye and Face Wash Station

Provides both hot and cold running water. For eye washing, simply pull "activator" pin out. Contains a 6-gallon tank for fresh water and a 7-gallon tank for waste water. Safety-lock casters. Cabinet: 32"L x 18 5/8"W x 39 1/2"H. Basin: 9"L x 11"W x 5"D. **Z42349 – \$2,750.00**



NE30357

NE30359

Rapid-Clear™ Portable Eyewash Stations

The ideal first response when a continuous or safe water supply is not available. Quickly flush contaminants from eyes with the sterile, buffered, preserved saline solution. Eyewash includes tamper-evident seal with easy-to-open twist-off top and is date-coded for easy inspection. Highly visible green plastic backboard can be wall mounted or placed on flat surface. FDA approved.

- NE30357** Single Unit Station - 16 oz. — **\$39.95**
- NE30358** Single Unit Station - 32 oz. — **\$54.95**
- NE30359** Double Unit Station - 32 oz. — **\$79.95**
- NE30360** Eyewash Refill Bottle - 16 oz. — **\$17.95**
- NE30361** Eyewash Refill Bottle - 32 oz. — **\$28.95**



Lysol® All-Purpose Cleaner

Cleans, disinfects, deodorizes, and kills 99.9% of bacteria on hard, nonporous surfaces. Lemon scent. 32-oz. bottle. **WA34866 – \$7.10**



E-Z Spray Bottles

Polypropylene sprayer with adjustable spray pattern. **C05706** Quart — **\$3.05**
C07664 Pint — **\$2.85**



Ultrasonic Cleaner Lab

Quiet, solid state circuitry; high-powered transducer for superior cleaning; large tank capacity; and cooling fan. Five cycles with digital time display. 1,400 ml (2.40 pints) capacity. 110V. 9" x 7" x 6 1/4". **SB47541 – \$164.95**

EXCLUDED FROM DISCOUNTS



Kimwipes® Delicate Task Wipers

Absorbs many times their own weight. Plastic guard on dispensing box reduces airborne lint, keeps contaminants out, and reduces electrostatic discharge. Box of 280; 4 1/2" x 8 1/2". **SB44520 – \$5.95**



Paper Towels

Strong, absorbent towels. 16 packages of 250 white 1-ply towels each 9 1/2" x 10 1/2". **WA04312(A) – \$129.00**

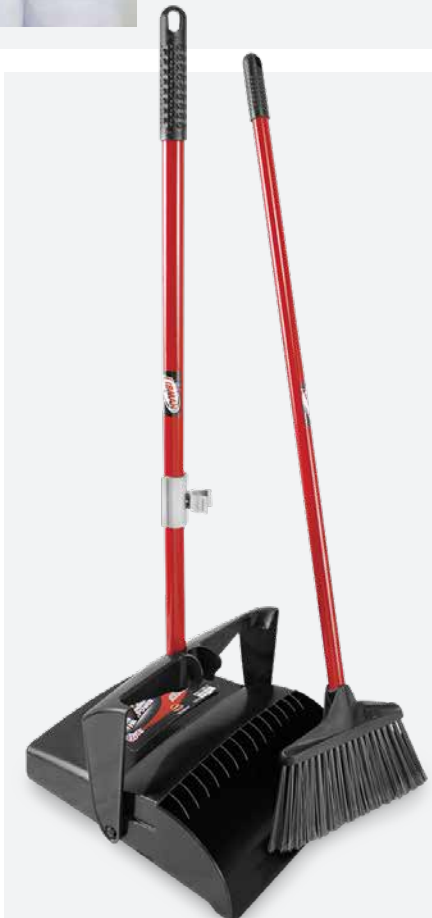

Dust Pan and Broom

Broom stores inside 12"W pan and clips to handle. Handle grip has hanger hole. Locks in upright position. Built-in tilt when open allows user to leave open. Dust pan is 36". **WA35395 – \$25.37**



Try our quick order feature for faster ordering on nascoeducation.com

Description	Product No.	Unit	Price
Alcohol, Isopropyl, 1 pt.	◆ KI01036(J)	Each	\$5.95
Aluminum Foil, 12" x 25' roll	SB30673	Roll	\$3.95
Aluminum Foil Pan, 4½"	K01049(H)	Each	\$0.55
Aluminum Foil Pan, 9", pk/30	K01054(S)	Pack	\$29.95
Bag, Paper, 10 x 20 x 7½ cm, pk/40	K01045(A)	Pack	\$4.55
Bag, Zipper Closure, 6" x 8", pk/100	SB50616	Pack	\$10.00
Bag, Zipper Closure, 9" x 12", pk/100	SB50614	Pack	\$13.50
Bag, Zipper Closure, 12" x 15", pk/100	SB50620	Pack	\$19.95
Bag, Zipper Closure, Quart, pk/100	SB51413	Pack	\$47.95
Bag, Zipper Closure, Gallon, pk/100	SB51414	Pack	\$66.95
Baking Soda, 1 lb.	K00365	Each	\$1.95
Balls, Golf, 1 doz.	PE00962	Pack	\$20.60
Ball, Steel, ¾", pk/24 ⚠ CHOKING HAZARD (3). Not for under 3 yrs.	K01041(B)	Pack	\$34.50
Balloon, Assorted, 11", pk/12	SB51399	Pack	\$2.50
Balloon, Assorted, 12", pk/12 ⚠ CHOKING HAZARD (2). Not for under 8 yrs.	SB51400	Pack	\$2.95
Balloon, Round, 7", pk/35 ⚠ CHOKING HAZARD (2). Not for under 8 yrs.	K01039(T)	Pack	\$4.95
Balloon, Round, 9", pk/35 ⚠ CHOKING HAZARD (2). Not for under 8 yrs.	K01046(P)	Pack	\$5.95
Balloon, Round, 9", pk/144 ⚠ CHOKING HAZARD (2). Not for under 8 yrs.	SB51401	Pack	\$21.95
Balloon, Round, 12", pk/50 ⚠ CHOKING HAZARD (2). Not for under 8 yrs.	9742228	Pack	\$7.35
Beaker, 250 ml, Glass	SB17979	Each	\$2.75
Blindfold, No Slots	SB41298	Each	\$2.15
Bulbs, Mini Lamp, 2.5V, #41, pk/10	S09289	Pack	\$4.00
Cards, Index, 3" x 5", Blank, pk/100	KI01046(Q)	Pack	\$1.95
Cards, Index, 3" x 5", Ruled, pk/100	BE01119	Pack	\$1.60
Carton, Egg, pk/25	C14067	Pack	\$10.75
Chalk, White, box of 12, Anti-Dust®	SB09901	Box	\$0.90
Cheesecloth, Purewipe®, 2-Sq. Yd. Piece	KI01045(E)	Each	\$2.90
Clips, Paper, box/100	9732828	Box	\$0.70
Clips, Paper, Jumbo, box/100	9732829	Box	\$1.10
Cloth, Wool, 6" x 6" pc.	SB13244	Each	\$3.95
Corn Syrup, Light, 32 oz.	KI01041(K)	Each	\$10.95
Cornstarch, 16 oz.	KI01039(V)	Each	\$4.75
Cotton Balls, Nonsterile, pk/300	KI05571(A)	Pack	\$4.95
Cotton Balls, Triple, bag of 100	KI05571	Bag	\$1.95
Crayons, Crayola®, #8, box of 8	9700786	Box	\$1.05
Cup, Paper, 5 oz., pk/12	K01054(H)	Pack	\$2.95

Description	Product No.	Unit	Price
Cup, Paper, 12 oz., pk/25	KI01431(B)	Pack	\$3.45
Cup, Paper, Cone, 4 oz.	K03250(C)	Each	\$0.10
Cup, Plastic, Clear, 3 oz., pk/40	KI01037(B)	Pack	\$6.70
Cup, Plastic, Clear, 10 oz., pk/16	KI01033(N)	Pack	\$4.95
Cup, Plastic, Clear, 10 oz.	SB41297	Each	\$0.55
Cup, Styrofoam™, 8 oz., pk/50	SB51682	Pack	\$5.00
Detergent, Liquid, 8 oz.	KI01054(V)	Each	\$4.25
Dish, Petri, 90 mm, pack of 20	SA00371	Pack	\$8.25
Dissecting Pins, 2", ½ lb. Box	SA01463	Box	\$11.75
Dominoes, Double Six, pk/28 ⚠ CHOKING HAZARD (1). Not for under 3 yrs.	TBI5635	Pack	\$2.25
Dropper, Medicine, 3" – 2 ml, pk/12	SA01161	Pack	\$5.25
Dropper, Plastic, Eye, pk/15	KI01066(A)	Pack	\$3.35
Fastener, Paper, #2, ½", box of 100	9701168	Box	\$1.90
Film Canister, pk/48	K01045(B)	Pack	\$27.25
Fishing Line, 25-yd. spool	9742234	Spool	\$3.50
Flashlight	SBI3626	Each	\$5.00
Flour, 2 lbs.	KI01058(K)	Each	\$4.95
Food Coloring, Blue, 30 ml	KI01054(L)	Each	\$2.95
Food Coloring, Green, 30 ml	KI01210(D)	Each	\$2.95
Food Coloring, Red, 30 ml	KI01039(X)	Each	\$2.95
Food Coloring, Box of 4	K00454	Box	\$10.95
Funnels, 2½" dia., pk/15	K01066(B)	Pack	\$14.70
Graph Paper, 8½" x 11", 50 sheets	9706099	Pack	\$2.25
Gravel, 1 kg	K01042(F)	Each	\$2.95
Gravel/Pebble, 1 kg (2.50 lbs.)	KI01049(I)	Each	\$4.50
Humus, 4-liter pkg.	K01048(J)	Each	\$5.75



Additional shipping charges apply.

Description	Product No.	Unit	Price
Ice Cream Sticks, pk/30	KI01046(X)	Pack	\$1.20
Iron Filings, Shaker, 1 lb.	S06119	Each	\$6.95
Lighter	◆ KI03662(H)	Each	\$3.30
Litmus Paper Strip, Blue, pk/100	K00173	Pack	\$1.95
Litmus Paper Strip, Blue and Red, pk/200	SB50608	Pack	\$3.75
Litmus Paper Strip, Red, pk/100	K00174	Pack	\$1.95
Magnet Bar, 2"L, 1 pair	SB14309	Each	\$10.50
Magnet, Ring, Ceramic, pk/6 ⚠ CHOKING HAZARD (1). Not for under 3 yrs.	K01056(K)	Pack	\$8.95
Magnifier, Plastic, 3X/6X	SB18031	Each	\$1.65
Marble, 1", pk/16 ⚠ CHOKING HAZARD (1). Not for under 3 yrs.	K01033(P)	Pack	\$3.95
Marble, ¾", pk/20 ⚠ CHOKING HAZARD (1). Not for under 3 yrs.	KI01046(F)	Pack	\$1.95
Marble, ¼", pk/90 ⚠ CHOKING HAZARD (1). Not for under 3 yrs.	K01056(L)	Pack	\$9.95
Masking Tape, ¾" x 60 yd.	9722434	Each	\$2.55
Measuring Cup, 8-oz.	SB41295	Each	\$1.75
Medicine Cup, pk/100	K01044(A)	Pack	\$3.05
Mirror, Acrylic, 3" x 5", pk/16	K01043(B)	Pack	\$20.50
Nutrient Agar, Liquid, 125 ml	KI03630(CB)	Each	\$6.00
Pan, Aluminum, 8" Square	KI01049(C)	Each	\$1.05
Paper, Chromatography, 15 cm x 2 cm, pk/100	SB52175	Pack	\$3.75
Paper, Graph, ¼", 11" x 17", pd/50	9706100	Pad	\$3.25
Paper Towel, White, 100 Sheet Roll	K00786	Roll	\$4.50
Pencil, China Marking, Black, pk/12	9701022	Pack	\$11.95
Ping Pong Ball, 1½" (38 mm) dia., pk/16	KI01033(D)	Pack	\$3.75
Pipe Cleaner, White, bag/100	0500592(A)	Bag	\$2.35
Plastic Wrap, Clear, 12" x 100'	KI01037(I)	Each	\$3.95
Plate, Paper, 9", pk/40	K01046(T)	Pack	\$4.95
Potting Soil, 4 qt.	KI01037(P)	Each	\$3.95
PTC Paper Strips, Vial of 100	K01525(F)	Each	\$4.05
Pulley, Single Sheave	SB12099	Each	\$3.55
Rod, Stirring Glass, 8"	K00186	Each	\$1.00

Description	Product No.	Unit	Price
Rope, Clothesline, Cotton	SB41296	Each	\$5.25
Salt, Table, 26 oz.	K00359	Each	\$2.55
Sand, Fine, 1 kg	KI01054(U)	Each	\$2.60
Sand, Fine, 2.5 kg	KI01046(V)	Each	\$6.25
Seeds, Bush Bean, 14 g	KI01037(J)	Each	\$2.95
Seeds, Radish, 1 oz.	KI01037(N)	Each	\$4.45
Seeds, Sunflower, Gray Stripe, 1 oz.	SB07340	Each	\$3.95
Soap, Clear, Hand, 7.5 oz.	K03607(NB)	Each	\$3.85
Soap, Clear, Ivory®, 24 oz.	KI03620(QA)	Each	\$6.95
Soap, Hand, Dial® Clean Citrus, 7.5 oz.	SB51198	Each	\$6.95
Soil, Clay, 16 oz.	K01049(L)	Each	\$6.95
Spoon, Plastic, pk/25	KI01046(L)	Pack	\$2.25
Straws, not wrapped, pk/200	KI01033(U)	Pack	\$5.75
String, 300'	K00129	Each	\$3.95
Sugar, Granulated, 1 lb.	KI01044(F)	Each	\$4.00
Tagboard, White, 9" x 11", pk/25	K01034(I)	Pack	\$2.25
Tagboard, White, 22" x 28", pk/100	9700994(B)	Pack	\$30.00
Tape, Adding Machine, 2¼"	KI01043(G)	Each	\$0.98
Tape, Electric, Black, ¾" x 60'	SB50541	Roll	\$1.75
Thermometer, Immersion ⚠ CHOKING HAZARD (1). Not for under 3 yrs.	SB15198	Each	\$3.95
Tongue Depressors, box/500	5500190	Box	\$9.50
Toothpicks, Flat, pk/750	KI01046(Y)	Pack	\$2.95
Tray, Brown, 10" x 14"	SB41303	Each	\$4.75
Vegetable Oil, 24 oz.	KI01044(D)	Each	\$6.50
Vinegar, 5% Solution, 1 pt.	K00364	Each	\$2.50
Washer, ¾" O.D., pk/100 ⚠ CHOKING HAZARD (1). Not for under 3 yrs.	K01041(I)	Pack	\$8.95
Wax Paper, Roll, 11½" x 75'	KI01046(Z)	Roll	\$4.95
Wipes, Disinfecting, 35 wipes	K03161(A)	Each	\$7.75
Yeast, Red Star, Dry, pk/3	KI01172(B)	Pack	\$4.85

Need help with custom science kits?

Our education specialists will hold your hand every step of the way to reduce your workload and your worry!

Call 1.800.558.9595 or email custserv@nascoeducation.com

⚠ See page 3 for complete Choking Hazard Label Information.

◆ DOT hazardous material ⚡ Subject to DOT hazardous material surcharge.



EARTH SCIENCE

Earth Science gives students the ability to explore the connections between the land, ocean, atmosphere, and life on our planet.

Start their exploration with experiments, weather kits, solar system replicas, and other tools that will help them learn about the planet we call home.

- Soil **168-171**
- Water **172-175**
- Oceanography **176-177**
- Environmental **178-183**
- Weather **184-191**
- Geology **192-195**
- Globes & Maps **196-197**
- Rocks & Minerals **198-201**
- Fossils **202-203**



ONLY AT NASCO

Nasco Soil Classroom Kit

Gr. 5-9 Gain an understanding of soil formation, soil composition, and soil chemistry, plus how soil factors into plant growth and ecosystems. Test the pH and NPK levels of soil samples, differentiate soil samples, and grow plants in various soils. ⚠ CHOKING HAZARD (1). Not for under 3 yrs.

SB48134 – \$235.00



Combination pH, Nitrate, Phosphorus, Potassium Outfit

Great for AP Environmental Science classes. Combination soil test kit with step-by-step instructions for individual or classroom use. Test result readings are measured against Mylar® laminated color charts. Enough reagents for 30 pH tests, 15 nitrogen tests, 20 phosphorous tests, and 15 potassium tests, plus 2 booklets. Comes with a hard case.

◆ C08704 – \$89.00



Soil NPK Test Kit

Gr. 5+ Perform up to 50 tests each for nitrogen, phosphorus, and potassium levels using non-hazardous TesTabs®. Comes with apparatus, instructions, and a laminated color chart.

SB42195 – \$40.50



Soil Analysis Kit

Determines texture, composition, particle size range, density, permeability, porosity, and pH. Kit comes with loam, silt, clay, sandy soil, topsoil, fine sand, coarse sand, and gravel. Includes sieve sets and all required supplies for testing, complete instructor's manual with worksheets, assessment materials, answer keys, and a reusable plastic tote.

Z51293 – \$349.95



Soil Test Kit

Give soil a checkup with simple, three-step tests that detect levels of common chemicals. Kit includes comparator box and 10 capsules for each of the following tests: pH, nitrogen, phosphorus, and potassium.

C14572 – \$19.95

Refill Pack for Soil Test Kit. Includes 10 capsules for each test (pH, nitrogen, potash, and phosphorus).

C34288 – \$11.95

Great for AP environmental science classes



LaMotte Soil Science Field Testing Outfit Model AM-31

Great for AP Environmental Science classes. All materials needed for establishing an accurate and detailed soil evaluation program. Chemical test equipment provided for soil pH, nitrogen, phosphorus, and potassium. Instructions and sufficient materials for making 50 tests. Includes apparatus for determining texture of soils, soil sampling tube, 50 soil sample bags, and carry case.

◆ C08681 – \$640.65

Refill Unit for Model AM-31. Reagents for 50 tests of each factor (250 tests total).

◆ C08682 – \$335.00



Chemical Composition of the Soil

Perform chemical determinations on locally derived soils for percentage of water; soil organic content; pH; reagent tests for calcium, carbonates, magnesium, and phosphates; and test paper determinations for potassium, sulfates, nitrate, ammonium, and iron. Discussion questions included. For 30 students working in pairs.

◆ SB09431 – \$194.95

⚠ See page 3 for complete Choking Hazard Label Information.

◆ DOT hazardous material ⚡ Subject to DOT hazardous material surcharge.



Soil Test Kits

Contains liquid reagents and equipment for the given number of tests.

Soil Test Kit with 80 Tests. Includes 20 tests each for soil pH, nitrogen, phosphorous, and potash. **C25446 — \$32.95**

Soil Test Kit with 200 Tests. Includes 50 tests each for soil pH, nitrogen, phosphorous, potash. **C25448 — \$150.00**

Soil Horizons

Presents and defines each layer of soil (organic, topsoil, eluviation, subsoil, regolith, bedrock). Display is topped off with a stem of grass showing the roots, as well as a mushroom with mycelium extending into topsoil. 12" x 16".

C34457 — \$194.95



United Scientific Metal Sieve Set

Gr. 5+ Separate soil or sediment particles of multiple sizes with these stackable metal sieves. Set includes 6 sizes: 4000 micron, 2000 micron, 500 micron, 250 micron, 125 micron, and 63 micron. All sieves are 20 cm in diameter and 4 cm deep. **NE30299 — \$215.95**



Elementary Sieve Set

Soil sorting just got easier for younger students with this colorful, nearly unbreakable set. Separate particle sizes into layers with the 5 plastic sieves. Each 8" dia. sieve is a solid-molded piece of polypropylene plastic. Catch pan at the bottom holds the smallest particles. Includes 5 mesh sieves with hole sizes of 1/16", 1/2", 1/16", 5/16", and 1/4" and instructions. **SB48161 — \$37.95**



Soil Analysis Kit

Gr. 6+ Soil composition has been a keystone in earth science classrooms for many years. This kit will teach students the skills needed to properly conduct soil composition tests as well as allow them to collect and evaluate local soil samples. By bringing in local soil samples, the students can build a stronger connection to their own local environment while still building on a knowledge base that can be applied to any other environment. **SB52473 — \$272.50**

Nasco Elementary Soil Classes

Identify the characteristics of the basic soil classes (sands, loams, and clays). Eight basic soil types (sandy loam, loam soil, clay soil, silt loam, muck soil, peat soil, clay loam, and sandy soil) in plastic tubes. Includes safety tube holders and extra tubes for collecting samples. **SB43552 — \$60.95**



How Soils Are Formed Collection

Contains rocks and minerals that break down to become the major components for soils. 15 number-coded specimens in a compartmented container with 1 1/2" x 1 1/2" compartments. Soils come in plastic bags. **C30192 — \$30.25**



Oil Test Paper

Light blue paper turns dark blue in the presence of hydrocarbons, particularly gasoline, fuel oil, and lubricating oil. Box of 100. **SB51167 — \$47.50**



Soil Probe with Handle

Window slot for easy sample recovery. Sturdy design prevents probe from bending or twisting out of shape. Use without a liner. Includes a removable, corrosion-resistant, 10" cross handle with grips. Nickel plated. **C35620 7/8" x 21" — \$149.99**

C35619 7/8" x 33" — \$149.99

BEST SELLER



Nasco Soil Classes Kit

Eight glass jars in thermo-formed plastic tray (one each of sand, sandy loam, clay loam, peat loam, silt loam, loam, clay, and muck). **LS00519 — \$50.95**



4-Way Analyzer

Measures light, soil moisture, soil pH, and soil fertility. Soil pH measured on a scale of 0-9, and a combined nitrogen-phosphorous-potash reading based on USDA standards. **C25384 — \$35.95**



Kelway Soil Acidity and Moisture Meter

Gives accurate pH reading of soil on outside scale of the dial while showing soil's moisture content on inner scale. Instructions and carry case with belt loop. **C09002 — \$150.00**



United Scientific 4-in-1 Soil Meter

Monitor sunlight, moisture, pH, and temperature levels all in one convenient handheld device. Features large, easy-to-read LCD screen, low-battery indicator, and 8" L probe to reach root-deep into soil. Requires 9V battery (not included). **NE30446 — \$29.99**



Digital Tapwater Tour
Gr. 4-8 Hands-on science curriculum and water test kit lets students investigate how and why the characteristics of tap water can vary and affect everyday activities. After reviewing material about pH, chlorine, hardness, copper, and iron, students work independently and in teams to test their own tap water samples. Classroom color chart, reagents, sample test bags, and an access code to downloadable versions of the instructor and student manuals. For 50 students.
SB53277 – \$97.50
Refill Kit
SB53278 – \$78.95



Innovating Science® Urban Water Investigation Kit
Gr. 6-12 Help students learn about how water quality affects urban areas. Collect water samples and test them for chloride, copper, iron, hardness, nitrate, pH, phosphates, and temperature. Kit contains materials for 10 tests and an NGSS-aligned instruction manual.
◆ NE30416 – \$130.00



Urban Water Test Kit
Gr. 3+ Introduce the basic concepts of water chemistry. Test tap water from any source and study the impact of urban water on the city's environment.
EL12088 – \$69.95



United Scientific Water Sampler
Gr. 5+ Capture water samples from specific depths with a water sampler. Made from impact-resistant PVC with soft rubber seals. Holds up to 1½ liters of liquid. When the desired depth is reached, students should pull the attached line to close the apparatus. Includes 20 m line on Styrofoam winding float and an activity guide.
NE30298 – \$100.95



Green Water Monitoring Kit
Gr. 4+ Low-cost, portable, easy-to-use water testing kit will analyze water samples for phosphate, temperature, turbidity, coliform bacteria, pH, dissolved oxygen, biochemical oxygen demand, and nitrate. Test fresh, brackish, or saline aquatic environments. Nonhazardous TesTabs®, instructions, and color chart. For 5-6 students.
SB33597 – \$52.95

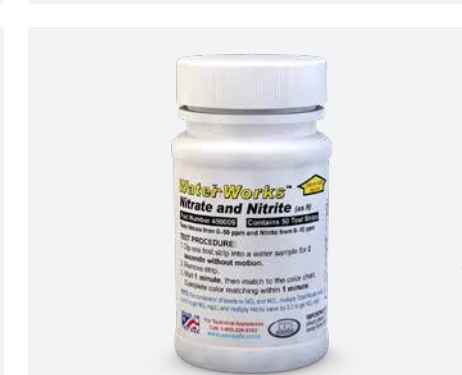

Nitrate/Nitrite Water Quality Test Strips
 Fast, easy, and reliable water test strips. Measure nitrate nitrogen and nitrite nitrogen. Nitrate range: 0, 0.5, 2, 5, 10, 20, and 50 ppm. Nitrite range: 0.15, 0.3, 1, 1.5, 3, and 10 ppm. Results obtained in 60 seconds. 50 test strips.
SB27487 – \$19.95



Water Sampler
 Sample water from any desired depth. Single-line trigger mechanism uses one line to both raise and lower the sampler and a trigger to seal the collection chamber; eliminating tangled lines. Flow-through design provides 1½-liter volume of water from which temperature and dissolved oxygen content can be determined. 18½" L x 3½" dia.
SB21418 – \$81.95



SB42510



SB42511



SB42508

Water Test Strips
 A quick and easy method of accurately measuring water quality. Each test has 50 strips.

Product No.	Test	ppm	Intervals	Each
SB42508	Phosphate	10-100	0, 10, 25, 50, and 100 ppm	\$18.95
SB42510	Hardness		0, 50, 125, 250, and 500 ppm	\$16.25
SB42511*	Fluoride	10-100	0, 10, 25, 50, and 100 ppm	\$17.00

* Test strips may be used to determine presence of fluoride in drinking water. NOTE: In order for the strips to work properly, hydrochloric acid solution (see p. 116) is needed. Use 1 oz. water to 1 oz. hydrochloric acid.

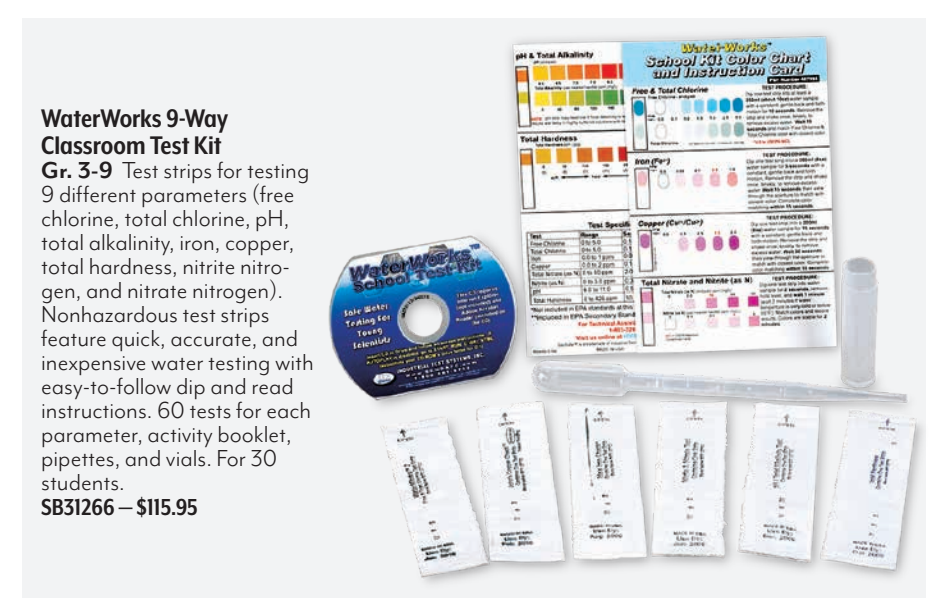

WaterWorks 9-Way Classroom Test Kit
Gr. 3-9 Test strips for testing 9 different parameters (free chlorine, total chlorine, pH, total alkalinity, iron, copper, total hardness, nitrite nitrogen, and nitrate nitrogen). Nonhazardous test strips feature quick, accurate, and inexpensive water testing with easy-to-follow dip and read instructions. 60 tests for each parameter, activity booklet, pipettes, and vials. For 30 students.
SB31266 – \$115.95



TesTab® Water Investigation Kit
 Investigate water pollution using safe, simple TesTab® reagents. Lightweight, field carrying case houses 12 individual test modules. Each module contains diagrammed instructions that are easy to read, color chart, test factor flash card, and all the necessary apparatus and nonhazardous TesTabs® to perform 100 tests. Also includes a manual and *The Monitor's Handbook*.
SB31250 – \$335.00

Water Nitrate-Nitrogen Test Kit
 Two-tablet reagent system to measure nitrate-nitrogen from 0 to 15 ppm (0 to 66 ppm as nitrate) in one-third of the time required for other nitrate kits. Unit-dose, foil-packaged tablet reagents eliminate the use of cadmium. Tablets for 50 tests; plastic test tubes with spill-proof caps; and plastic Octa-Slide color comparator with values 0, 1, 2, 4, 6, 8, 10, and 15 ppm nitrate-nitrogen.
CI5162 – \$79.80





ONLY AT NASCO

A. Nasco Creature Seeker Pond Kit

Gr. 3–9 Use microscopes and photo keys to identify creatures in the water, relate organisms found to the health of the ecosystem, keep records of results, and more. Includes field trip collection container, 3½-gallon pail, nylon pipette, 4 petri dishes, 4 plastic spoons, 4 plastic cups (3 oz. each), two-way microscope, 4 hand magnifiers, 8" x 12" plant trays, 4" plastic forceps, dry-erase marker, nylon ladle, insect net, 3 different laminated keys to macro-invertebrates sheets, and instructions. **⚠️ CHOKING HAZARD (I).** Not for under 3 yrs. **SB44662 – \$77.95**

B. Fieldmaster® Student Net

Investigate ponds, streams, lakes, and seashores. Net has 3 mesh openings. Nitex® nylon collects even the smallest size plankton. Patented Mini Dolphin™ adapter with 125 ml sample bottle can be used in place of a bucket. Fine mesh, 80 microns. **SB37276 – \$125.00**



EXCLUDED FROM DISCOUNTS



C. Student Aquatic Net

8" square steel hoop, 6"D mesh capturing bag, soft 3/16" mesh grid size, and 20" knotless pine handle. **SB43412 – \$6.25**

D. Dissolved Oxygen TRACER PockeTester™

Waterproof PockeTester™ can be intermittently submerged to a depth of 3'. Waterproof feature makes cleanup easy and quick. Oxygen level displayed as % saturation from 0 to 200.0% or concentration from 0 to 20 ppm (mg/L). Adjustable altitude compensation: 0–20,000' in 1,000' increments. Adjustable salinity compensation from 0–50 ppt. Memory stores up to 25 data sets with DO and temperature reading. Self-calibration on power up, data hold, auto power off, and low battery indicator, DO electrode, protective sensor cap, spare membrane cap, electrolyte, four 1.5V SR44W batteries, and 48" neck strap. **SB40757 – \$579.00**

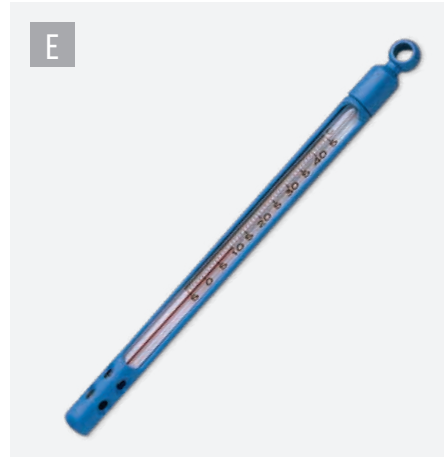

E. Armored Thermometer

Precision, non-mercury thermometer in protective plastic jacket with window opening. Engraved graduations on white tubing increase readability over range of -5°C to 45°C in 0.5° increments. 6"W x 1"H. **SB42137 – \$31.95**

That's just the start!
See more options at
nascoeducation.com

Includes enough tubes to perform 25 tests



Coliform Test Kit

Gr. 7+ Coliforms are a broad group of bacteria mostly found in the intestines of warm-blooded animals. Presence of coliforms may indicate a possible presence of other pathogenic or disease-causing organisms. Students add a small amount of collected water to a sample tube and incubate for 24–48 hours. Distinct color change indicates that coliforms are present. Instructions and 25 lactose tubes. **SB49025 – \$64.95**



Pondwater Tour Kit

Gr. 4–8 Hands-on test kit guides students through the study and measurement of changes in dissolved oxygen, nitrate, pH, and ammonia in a lake, stream, pond, or aquarium. Lecture materials, handouts, teacher tips, test procedures, data sheets, games to reinforce key concepts, Tes Tabs® reagent tablets, and sample test bags for a class of 50 students. **◆ SB26203 – \$110.95**

Reagent Refill Only
◆ SB26204 – \$87.95

BEST SELLER



Qualitative Introduction to Water Pollution Kit

Gr. 8+ Perform qualitative tests on natural and treated water to become aware of the significance of water pollution. Identifies 10 common pollutants, as well as the determination of pH. Tests include ammonia, chlorine, chromium, copper, cyanide, iron, nitrate, phosphate, silica, sulfide, and pH determination. Teacher's instruction booklet and background information. For 50 students. **⚠️ CHOKING HAZARD (I).** Not for under 3 yrs. **◆ SA08211 – \$286.95**



EXCLUDED FROM DISCOUNTS

Leaf Pack Experiments Stream Ecology Kit

Gr. 3+ Design, implement, and analyze a scientific investigation while discovering the value of aquatic macroinvertebrates as living indicators of water quality and the overall health of a stream ecosystem. Includes instructor's manual with background material on stream ecology, glossary, diagrammed instructions, experiment ideas, and field and lab data sheets. Use for AP Environmental Science classes. **SB29984 – \$326.00**



Ocean Trash Can Kit
Gr. 7-10 Examines pollutants, their sources, and their effects on the ocean, its inhabitants, and surrounding coastline. Classify ocean pollution into 5 categories (debris, toxins, dissolved nutrients, particulates, and oil), then model its effects with activities about the effect of the pH of various liquids on calcium carbonate, dilution, salt and acid runoff, and more. Requires 4 class periods plus research time and six 1-gallon milk containers (not included). For 24 students working in groups of 4. **CHOKING HAZARD (1)**. Not for under 3 yrs. **SB42134 – \$104.95**



Kemtec™ Ocean Science Kit
Gr. 5-9 Examine the physical and chemical properties of seawater and learn how they affect ocean currents and marine environments. Then explore the effects of heat from the sun, precipitation, evaporation, freezing and thawing of sea ice, the inflow of fresh water from rivers, effects of new dams, melting ice caps, and global temperature drops. For 24 students. Meets NGSS. **NE30590 – \$99.00**



How Clean is the Water We Drink and the Air We Breathe?
Make the invisible, visible. Students sample water and air and then grow any microbes present overnight. A safe way to teach about pollution. Includes 1 bottle of ReadyPour™ Agar, 3 sleeves of Petri plates, 2 pipettes (10 ml), pack of 1 ml pipettes, a 20 ml sterile water sample, and a guide with activities. **SB26185 – \$70.00**



9 EXPERIMENTS IN 1
Take the entire class on an environmental testing journey

Innovating Science® Environmental Testing Kit
Gr. 6-12 This kit includes 9 different tests to determine the air and water quality of samples you collect from your community. Kit contains materials for 30 students working in groups. Teacher's guide and student worksheets aligned to NGSS included. **NE30414 – \$66.50**



Nasco Ocean Acidification Kit
Gr. 6-12 While most discussions about climate change focus on atmospheric CO₂ concentration and surface temperature changes, this kit explores changes to our oceans. How could climate change affect them? Aligned to NGSS, students will build their own conclusions through research, discussion, and experimentation. Includes air sensor for data collection, beakers, pH solutions, and teacher guide. **SB53393 – \$505.00**



Ocean in a Box
Set of 20 specimens includes algae, sea bean, finger sponge, silk or wool sponge, sea horse, hard coral, soft coral, sea star (starfish), sand dollar, barnacle shell, center-cut shell, tusk shell, moon snail shell, turritella shell, olive shell, turkey wing shell, pectin shell, clam shell, murex shell, and turban shell. Specimens individually bagged with fact card. 10" x 7" x 4" cardboard box. Specimens may vary. **SB40476 – \$46.95**



Oil Spill Cleanup: Biological vs. Physical Lab
Gr. 9+ Apply both a special blend of oil-degrading microbes and a hydrocarbon-encapsulating polymer to oil and examine the results, drawing conclusions on the effectiveness of each approach. Includes a stained vegetable oil to simulate crude oil, allowing the use of real oil without any of the hazards and associated disposal costs. Materials for 15 students, teacher's manual, and student study guide copy-masters. **SB50315 – \$97.95**



Innovating Science® Ocean Acidification Kit
Gr. 6-12 Through 3 different activities, students will investigate the cause of ocean acidification and the effects it can have on the ecosystem and marine life. Kit contains materials for 15 groups of students. NGSS-aligned teacher's guide and student study guide copymasters included. **NE30415 – \$36.95**

Find out how easy it is to connect your school's e-procurement system on nascoeducation.com

BEST SELLER



A. Environmental Chemistry: Acid Rain, Weathering, and Erosion
Gr. 7+ Learn about the effects of acid rain on both naturally occurring and man-made surfaces by exposing many rock materials and metals to an acidic environment and contrasting the reaction of these materials to the same materials exposed to “normal” rain (tap water). For 15 groups, including teacher’s manual and student copy-masters.
◆ C29411 – \$67.95

B. Electrochemical Remediation of Wastewater
Gr. 6+ Perform an alternative, greener approach to wastewater treatment. Electrocoagulation, a process for treating wastewater carried out by an electrical charge. For 15 groups.
SB45474 – \$76.95

C. Innovating Science® STEM Investigations: Design a Water Filter Kit
Gr. 6–12 Students will learn about the processes performed at water treatment facilities and engineer their own small-scale filtration plant. Contains materials for 15 groups of students. NGSS-aligned teacher’s guide and student study guide copymasters included.
NE30426 – \$69.95



D. PocketLab Air Sensor
 Wireless sensor sends data to an app for exploring the world and investigating air quality and climate. Sensor functions allow viewing of data in real-time. Connect to your device via Bluetooth® 4.0 and instantly stream data simultaneously on carbon dioxide, ozone, particulate matter, air quality index, barometric pressure, humidity, light, and ambient temperature. Record up to 30,000 measurements to the onboard memory and integrate through PocketLab Cloud Software, Google Drive™, or Microsoft® Excel. App is compatible with iOS, Android™, Mac OS®, and Chromebook™. Rechargeable lithium polymer battery lasts up to 12 hours. Wireless range: 250' (76 m) line-of-sight. 4" x 2½" x 1½".
SB53295 – \$348.00

E. Water Treatment & Filtration Kit
Gr. 6+ Water delivered by municipal water supply must be treated prior to delivery to ensure health and safety. Perform several of these steps on “raw” water and examine changes in the physical properties after each step. For 15 groups.
SB45473 – \$78.95



Climate Change: Carbon Cycling Kit (Developed by EDC)
 Engage in four activities related to carbon and its movement through the carbon cycle. Students build molecular models to better understand some of the everyday reactions that allow carbon atoms to form different molecules and move from one place to another; next, students do a basic analysis of Earth’s major carbon sources, sinks, and associated fluxes. For 32 students per class. Contains no consumable materials. **⚠ CHOKING HAZARD (I).** Not for under 3 yrs.
C34433 – \$244.95



Kemtec™ A Space Farm Kit
Gr. 4–6 Experiment with soil-less growing to understand how we might grow our food in an outer space environment different from Earth’s. Includes information about hydroponic cultivation, petri dishes, space soil, seed germination media, space nutrients, plastic zip bags, plastic grow cups with lids, toothpicks, pea seeds, sunflower seeds. No included: one 1,000 mL beaker or one 2 qt. container and distilled water. For 24 students. Meets NGSS.
◆ NE30587 – \$154.00

BEST SELLER

Now You See It, Now You Don’t™ See-Through Compost Container
 Learn about decomposition, composting, life cycles, and environmental education. Three aerated compartments let students view the decomposition process and make side-by-side comparisons. 5¼"D x 13"W x 8"H clear plastic box with faux grass top, thermometers, and guide.
SB47477 – \$44.95



⚠ See page 3 for complete Choking Hazard Label Information.

◆ DOT hazardous material **⚡** Subject to DOT hazardous material surcharge.



Innovating Science® The Carbon Cycle in Soil Kit
Gr. 6–12 In 3 different activities, students will investigate the carbon cycle in soil, how soil impacts global warming, and the effects of a positive feedback loop. Includes materials for 15 groups of students, teacher’s guide, and student study guide copymasters.
◆ NE30417 – \$116.00



Decomposition Kit
Gr. 5+ Explores two very important concepts in studying life cycles: biodegradability and decomposition. Participants investigate the effect of various factors on decomposition and biodegradability. For 50 students or 24 groups. **⚠ CHOKING HAZARD (I).** Not for under 3 yrs.
SB28793 – \$191.50



Ecological Succession

Gr. 6+ Game provides an active learning alternative to passive methods of studying ecological succession. Within each successional stage, students react to disturbance events and come to understand how disturbances affect the different communities. For 24 students working in groups of 4. **△ CHOKING HAZARD (I).** Not for under 3 yrs. **SB51216 – \$138.95**



Science Learning Center – Ecosystems, Food Chains, & Food Web

Gr. 5+ Learn and review essential standards-based environmental science skills. Designed for teacher-directed instruction or independent learning working in groups of 2-4 students. **△ CHOKING HAZARD (I).** Not for under 3 yrs. **SB53130 – \$35.95**

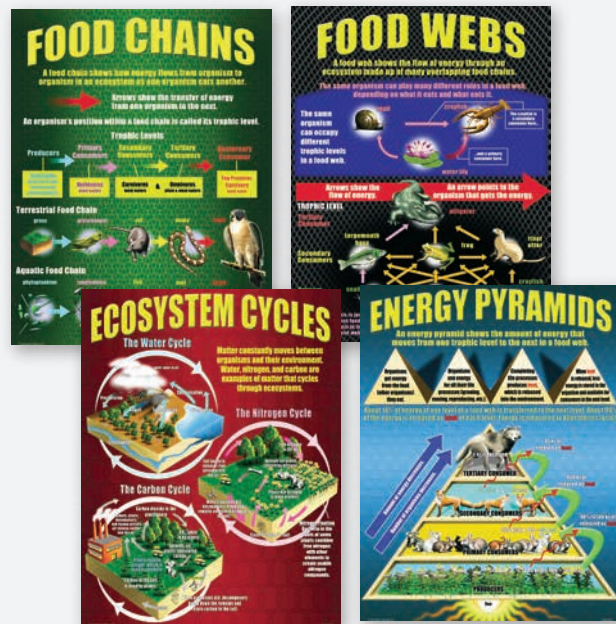

Ecosystems Teaching Poster Set

Focus on food chains, food webs, and energy pyramids show how energy moves through an ecosystem and the interactions between organisms within it. Cycle models show how matter flows through organisms and the physical environment. Includes 4 posters (17" x 22"), 4 reproducible activity sheets, and a teacher's guide. **SB50481 – \$9.95**



Nasco Earth Science Lab Kit

Student earth science lab station in a well-packaged, portable container designed for non-conventional lab situations such as home schooling, or any situation that calls for an uncompromised lab experience with or without the presence of an experienced lab teacher and without the need for a traditional lab facility. Preparation, safety, and cleanup is convenient and easy. Hands-on lab course has everything needed to perform 31 earth science experiments (other than some common household items), including over 40 types of equipment, 24 different types of rock and mineral samples, and a 150-page manual with step-by-step instructions written to clearly teach an earth science concept. **EXCLUDED FROM DISCOUNTS**
Z50308 – \$215.00



Nasco Track Mold Kits

- Identify wildlife from tracks
- Use in all animal and bird study
- Plaster casting, 5 lbs.
- Study adaptation to environment
- Ink prints
- Reproduce tracks and track patterns in class

Aids students in the study of animal life. By making replicas, they become familiar with tracks of wild, domestic, and exotic animals. Kits contain all materials needed for making replicas — a variety of molds made from actual animal tracks, 5-lb. tub of casting plaster, and instructions.

Volume 1

One foot of wolverine, wolf, and yearling moose; fore and hind foot of fisher, porcupine, snowshoe rabbit, and land otter. **SB33680 – \$149.95**

Volume 3

Fore and hind foot for mink, coyote, woodchuck, gray fox, opossum, gray squirrel, and deer. **SA05425 – \$134.95**

Volume 4

Fore and hind foot molds of mountain lion, badger, antelope, and jack rabbit; 1 foot of elk and buffalo. **SA05426 – \$172.95**

Casting Plaster. 5-lb. package. **9730282 – \$21.00 24+ \$18.22**



SB33680



Moose

Bald eagle

Individual Tracks

SB46523 Yearling moose. 8 3/4" L x 3 1/4" W x 1 1/8" H — **\$27.95**

SA00398 Bald eagle. 8 3/4" L x 3 3/8" W x 1 1/8" H — **\$11.00**

ONLY AT NASCO
Use molds made from actual animal tracks to make replicas to help students identify wildlife



TRACE THE TRACKS
Learn the language of wildlife



Grids break down for easy storage



Field Identification Grid

Use for group field identification. PVC pipe grid is easily folded and stored. 20"L x 20"W. SB42804 — \$32.95



Eggs of North American Birds

Set of 36 true-to-life replicas show eggs laid by a diverse collection of North American birds, from the diminutive ruby-throated hummingbird to the great blue heron. Replicas secured in a labeled 12" x 16" exhibit case. SB51345 — \$430.00



Nasco Owl Pellets

Compact balls of fur, feathers, and bone that have been regurgitated by an owl after feeding. Dissection of these pellets helps students gain insight to predator-prey relationships.

SB09759 — \$4.25

Small Pellets
SB09759(SM) — \$2.55

Nasco Bucket O' Pellets — Large. 100 large pellets in plastic bucket with lid. SB42866 — \$325.00

Nasco Basic Owl Pellet Kit

Gr. 3-7 Study food chains from regurgitated owl pellets easily dissected to expose skulls and other skeletal parts. Undigested remains provide bones, teeth, hair, or feathers of prey animals. Charts of skulls and skeletons help identify prey animals. Includes 15 dried and fumigated owl pellets wrapped in aluminum, 15 student worksheets, and teacher's guide. SB20193 — \$58.95

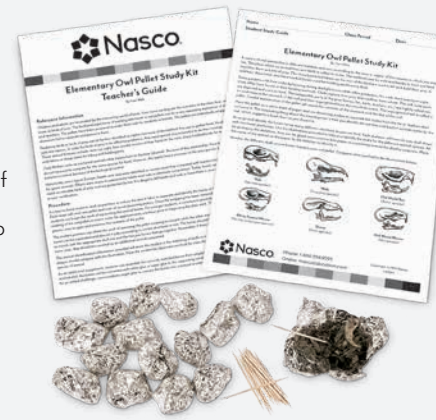

ONLY AT NASCO

Nasco Owl Pellet Classroom Kit

Gr. 4-8 Everything you need to begin owl pellet dissection. Teaches predator-prey relationships, energy transfer through food chains, and more. Includes a bucket with 100 owl pellets, 15 learning guides for students working in pairs, and a 40-page resource guide with lessons, vocabulary, and assessments. Aligned to NGSS. SB53337 — \$415.00



ONLY AT NASCO



Nasco Advanced Owl Pellet Kit

Gr. 7+ Learn about predator-prey relationships through analysis of owl pellets. Observe skeletal features to identify prey animals consumed and learn about energy transfer through food chains. Includes 15 dried and fumigated owl pellets wrapped in aluminum, probes, owl pellet study chart, 15 student worksheets, and teacher's guide. SB20192 — \$81.95

ONLY AT NASCO



ONLY AT NASCO

A. Nasco Food Web Collapse Game

Gr. 5-8 Fast-moving strategy game teaches the structure and function of food webs. A round takes 10-15 minutes. Aligns with all state standards for teaching about food webs. Guide sheets, cards, stickers, and instructions. For up to 30 players. SB47891 — \$42.95



B. Animal Bites™

Gr. 2+ Learn about the diversity of diet within the animal kingdom. Includes samples from each group: herbivore (beaver, mountain gorilla, hippo); carnivore (coyote, African lion, alligator); and omnivore (human, grizzly bear, baboon). Includes lesson plans and interactive exercises. SB37286 — \$129.95



C. Nasco Bucket of Scat

Includes 13 scat replicas of common North American animals in storage bucket. SB49923 — \$129.95

NEW

Reusable owl pellets look just like the real thing!



Eisco Simulated Owl Pellets

Get a clean and safe dissection experience every time with reusable simulated owl pellets containing highly detailed skeleton replicas. Carefully designed by laboratory professionals and engineers with quality and durability in mind. Handmade with the highest-grade raw materials according to international quality standards. **⚠ CHOKING HAZARD (1).** Not for under 3 yrs. NE30583 Single Pellet, Mouse — \$14.95 NE30584 Single Pellet, Bird — \$14.95 NE30585 Single Pellet, Vole — \$14.95



Mouse



Bird



Vole

BEST SELLER



Acurite® 5-in-1 Weather Station with Color Display

Keep current with temperature, humidity level, barometric readings, wind readings, and forecast. Forecast indicator includes icons with 14 different weather conditions and self-calibrates for altitude. View past temperatures, humidity, and barometric pressure readings. Continuous streaming weather ticker scrolls text and provides weather alerts. Connect display to a computer to download weather data. Main unit has a temperature range of 32° to 122° F (0° to 50° C) and a humidity range of 16% to 98%. Outdoor sensor has a temperature range of -40° to 158° F (-40° to 70° C), humidity range of 1% to 99%, wind range of 0-99 MPH, RF range of 330' (100 m), and measures rainfall up to 100". AC adapter for display included. Sensor requires 4 "AA" batteries (not included). 2 year battery life. View your sensors on any iPhone, Android smartphone, computer or tablet with the complimentary My AcuRite App. **SB50359 – \$274.99**

With Lightning Detector. Measures temperature, humidity, wind speed, wind direction, and rain. Alerts you to oncoming storms from up to 25 miles (40 km) away, with real-time streaming capabilities. Outdoor sensor temperature range: -40° to 158° F (-40° to 70° C). Humidity range: 1% to 99%. Wind range: 0 to 99 mph. Rainfall: 0.05" per inch of rainfall. Wireless range: 330'. **SB52022 – \$232.95**



Weather Station Kit

Gr. 3+ Features a wind vane, anemometer, thermometer, and rain gauge. **CHOKING HAZARD (1).** Not for under 3 yrs. **SB48176 – \$20.95**



Soda Bottles

Cap not included, sold separately (SB53276, below).

Product No.	Size	Each	10+
SB53274	2 liter	\$1.75	\$1.56
SB53275	20 oz.	\$1.35	\$1.22

Soda Bottle Cap. **CHOKING HAZARD (1).** Not for under 3 yrs. **SB53276 – \$0.50** 10+ **\$0.45**



United Scientific Mini Weather Station

Gr. 5+ Introduce students to basic weather concepts with this versatile apparatus. Use to measure temperature and wind speed, then reference the chart to calculate wind chill. It freely rotates to indicate wind direction. Removable rain gauge can be used to quickly assess rainfall. **NE30302 – \$9.00**



AcuRite® Digital Weather Station

Teach students all about the weather by monitoring conditions in real-time! Measures and displays outdoor temperature, humidity, daily high/low records, and barometric pressure; indoor temperature and humidity; moon phase, date, and time. LCD display and wireless sensor. Requires 2 AA batteries (not included). Includes one-year limited warranty. **NE30445 – \$49.99**



AcuRite® Atlas 7-in-1 Weather Station

Engage students with minute-by-minute weather updates! Measures and displays outdoor temperature, humidity, wind speed/direction, UV, light intensity, barometric pressure, rain totals, indoor temperature, humidity, and barometric pressure. HD display with optional battery backup, wireless sensor, and lightning detector. One-year limited warranty. **NE30444 – \$359.99**

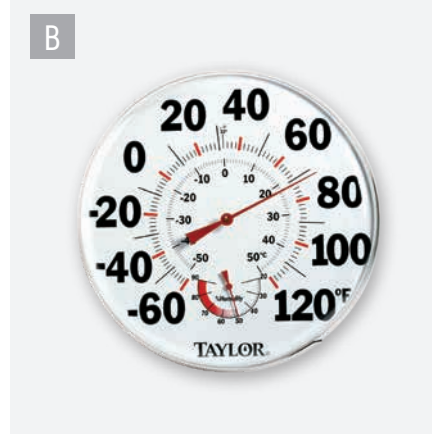
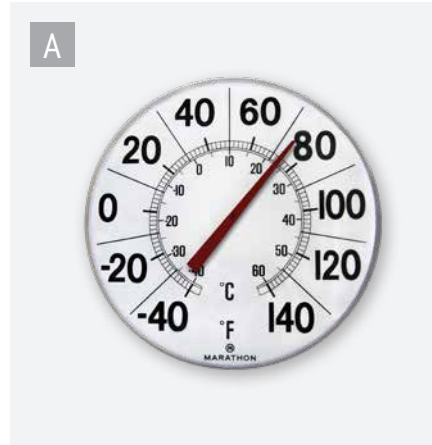

A. Indoor/Outdoor Giant Round Thermometer

12" dia. display thermometer with large numbers for reading at a distance. Range: -40° to 140° F (-40° to 60° C). Keyhole slot for mounting. **SB42182 – \$24.95**

B. Thermometer with Relative Humidity

Jumbo thermometer is easy to read at a distance. 12" dia. Fahrenheit, Celsius, and relative humidity scales. Hang indoors or out. All metal construction with plastic covered face. **SB01068 – \$29.95**

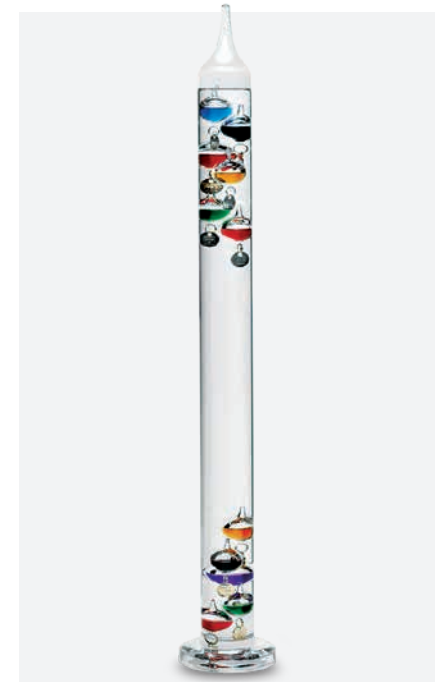

Galileo Thermometer

Glass cylinder thermometer contains hand-blown, calibrated glass spheres, each imprinted with designated temperature reading medallions. As temperatures fall, spheres will rise; as temperatures rise, spheres will sink. Range: 60° to 100° F. 24"H. **SB31402 – \$74.95**

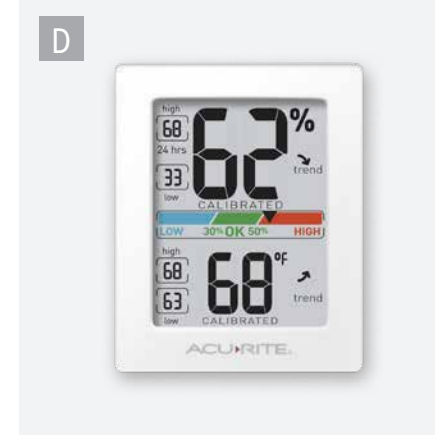

C. AcuRite® Color Weather Forecaster

Measures indoor/outdoor temperature. Displays daily highs and lows. 12- to 24-hour forecast. Atomic clock and calendar. 1"D x 7 7/8"W x 6 3/16"H. For tabletop or hang on wall. Sensor range: -40° to 158° F (-40° to 70° C) and an RF range of 330'. Requires 5 "AA" (not included). **SB52517 – \$81.95**

D. AcuRite® Indoor Temperature and Humidity Monitor

Temperature sensor: -40° to 158° F (-20° to 70° C). Indoor humidity: 1% to 99%. 24-hour highs and lows. Wireless. 2 1/2"L x 1"W x 3"D. Requires 2 "AAA" batteries (not included). **SB52516 – \$22.95**



AcuRite® Galileo Thermometer & Barometer

Temperature range: 64° to 80° F. Determine atmospheric pressure by the level of liquid in the barometer. Low level indicates high pressure and fair weather; high level predicts bad weather is on the way. Instruments come together on a wooden base. 4 1/2" x 3/4" x 9". **SB48147 – \$39.95**



E. AcuRite® Color Weather Station

LCD screen with indoor/outdoor temperature and humidity, barometric pressure, cloud cover, precipitation, 12-hour weather history, calendar, and clock. Tabletop or wall mount. Wireless range: 330'. Temperature range: -40° to 158° F (-40° to 70° C); accuracy ±2° F. Humidity range: 1% to 99%. 8"L x 7"W x 3"D. Sensor requires 2 "AA" batteries (not included). **SB51160 – \$102.95**

BEST SELLER

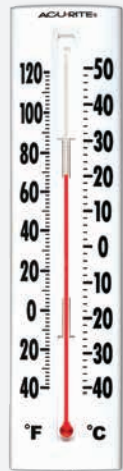

Classroom Thermometer

Indoor/outdoor use. Wall-mounted. Range: -40° to 120° F (-40° to 50° C). 14" x 3".
TBI8809 — \$8.75



Taylor® Weather Thermometers

Spirit thermometer is easy-to-read. -40° to 120° F (-40° to 50° C). Weather resistant. Indoor/outdoor use. Set of 6; 7 5/8" x 2 3/8".
S01034 — \$19.95



Giant Classroom Thermometer

30" wall-mounted thermometer has 23" tube on a wooden base. F°/C° scales. Range: -40° to 120° F (-40° to 50° C).
◆ TBI5831 — \$39.95

EXCLUDED FROM DISCOUNTS



PocketLab Sensors - PocketLab Weather

A rugged weather center that can measure temperature, humidity, light, barometric pressure, heat index, dew point, and can connect to an external temperature probe. Build a weather balloon and use PocketLab Weather to gather climate data as it travels through the sky and discover why lightning strikes by observing changes in atmospheric data during a storm. Ideal for maker projects and science experiments. Open access to over 35 online experiments and demos. Wireless range: 250' (76 m) line-of-sight. Onboard memory: 32,000 data readings. Rechargeable battery provides over 40 hours of use per charge during wireless operation. Bluetooth® 4.0 wireless connection. PocketLab app is compatible with iOS, Android™, Windows® 10, Mac OS®, and Chromebook™. 1 1/2" x 1 1/2" x 5/8". **⚠ CHOKING HAZARD (I). Not for under 3 yrs.**
NAI0341 — \$128.00

BEST SELLER



Wind Vane

Gr. 8+ Economical tool for meteorology lessons. Each directional pole is marked with 1 1/2" H letters. Sensitive cone bearing assembly responds to the slightest wind. Tip-resistant plastic base. 3 1/2" x 3 1/2" x 7 7/8". Vane length (rudder to pointer): 7 1/2". **⚠ CHOKING HAZARD (I). Not for under 3 yrs.**
SB43543 — \$25.00

Dial Barometer

Large, clear, dual scale in hPa (hecto Pascal), and mmHg on a 4" dia. dial that is easy to read from a distance. Accuracy of ±3 to 4 hPa. Wall mount.
SB23610 — \$30.95



Aneroid Barometer

Perfect for giving demonstrations. Features a protective transparent case, air-tight seal, and pressure bulb to force movements.
SB48285 — \$29.95

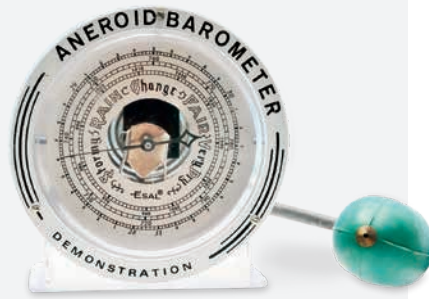

Weather Ball Barometer

Indicates changes in air pressure quickly and accurately. Once the ball is filled with colored distilled water, air trapped inside ball is no longer subject to variations in atmospheric pressure. 7 1/2"H x 4" dia.
SB33482 — \$36.95



Sling Psychrometer Kit

Gr. 7+ Use to measure relative humidity. Two plastic-backed Celsius thermometers: one for dry bulb measurements and one for wet bulb measurements. Mounted on a wooden handle so they can be spun to obtain temperature readings. Activity guide.
SB51739 — \$10.95
SB51740 Set of 15 — \$112.95



Anemometer

Demonstrates operating principle of cup anemometers. Extra-sensitive model responds to wind velocities of 2 mph. Made of corrosive-resistant materials for outdoor use. Includes teacher's guide.
SB16581 — \$14.95



Hand-Held Anemometer

Get a direct reading of wind speed without count revolutions. As wind blows harder, arms move, lifting reading bar.
SB25130 — \$34.50



NeuLog CO₂ Sensor

Plug-and-play technology allows for an intuitive, easy-to-use data logging platform. Wireless (SB50671) or USB (SB50672) required to operate sensor. See p. 35 for complete description.
SB51188 — \$325.00



Centigrade Pocket Sling Psychrometer

With recessed psychrometer bulbs to prevent breakage during use. Range of -5° to 50° C in 1° divisions. Red liquid filled. Water reservoir eliminates need to constantly re-wet wick. Carry case and plastic chart.
SB47136 — \$138.95

That's just the start!
 See more options at
nascoeducation.com

Mini Environmental Quality Meter

Monitor wind speed, air temperature, and relative humidity. Lightweight unit with backlight senses airflow as low as 0.4 m/s. Min./max. and hold features. Wrist strap, carry pouch, and button cell battery. 4 3/4" x 1 3/4" x 7/8".
SB49886 — \$139.95



AcuRite® Portable Anemometer with Inspection Light

Measures real-time, average, and peak wind speeds. Extendable air velocity meter ensures accurate wind speed readings and measures wind velocity in hard-to-reach places. Customizable wind speed alarm. Backlit LCD and LED inspection light offers reading visibility and vane placement in dimly lit areas. Wind speed range: 0-60 mph and 0-52 knots. Temperature range: -40° to 158° F (-40° to 70° C). 1 5/16"D x 2 1/2"W x 7 3/16"H. Requires 3 "AAA" batteries (not included).
SB52515 — \$50.95



⚠ See page 3 for complete Choking Hazard Label Information.

◆ DOT hazardous material **⚡** Subject to DOT hazardous material surcharge.

BEST SELLER

A



ONLY AT NASCO



B



C

ONLY AT NASCO



D

ONLY AT NASCO



E

ONLY AT NASCO



F

ONLY AT NASCO

A. Nasco Weather Kit
Gr. 6–8 Inquiry-based, idea-centered, hands-on kit dealing with weather phenomena, measurement, and interpretation of weather data. Includes equipment and materials to conduct 70 different investigations/activities, storage chest, replacement parts available at reasonable cost, and specific weather instrument kits available as separate items. Teacher's guide with blackline masters and answer keys. **CHOKING HAZARD (1, 2).** Not for under 3 yrs.
SB22636 – \$232.00

B. Innovating Science® Exploring Meteorology Kit
Gr. 6–8 Students will study pressure changes and wind speed, create their own barometer and anemometer, and learn how to read a weather map. Includes experiment materials for 30 students working in pairs, enough materials for 5 demonstrations, and NGSS-aligned teacher's guide.
◆ NE30418 – \$67.95

C. Nasco Weather Mini Kit Instrument Pack
 Includes one of each: weather vane, anemometer, barometer, hygrometer, and thermometer. Instructions. **CHOKING HAZARD (1).** Not for under 3 yrs.
SB24802 – \$42.95

Nasco Weather Kit Instrument Packs
 Use to collect weather data for extended periods. For individual or classroom use. Packs of 10.

D. Weather Vanes
SB22658 – \$49.95

E. Barometers
SB22660 – \$104.95

F. Anemometers
SB22659 – \$64.95

NEW



Kemtec™ Severe Weather Kit
Gr. 3–5 Learn about the weather and climate in different locations and then design and build structures to withstand intense forces caused by severe weather, such as high winds, heavy rains, and flooding. Full list of supplies online.
NE30588 – \$420.00

NEW



Kemtec™ Weather & Seasons Kit
Gr. K–4 Includes activities for temperature data collection, construction of a data table, graphing weather data, measuring temperatures, making weather reports, predicting weather, presenting weather data in various formats, graphing seasonal changes in the positions of the Earth relative to the sun, comparing shadow lengths, and making sundials. Meets NGSS.
NE30589 – \$456.00



Weather Forecasting Set
Gr. 5–8 Students work together in teams to interpret weather maps from 8 consecutive days. Each team interprets the map for a single day and constructs a weather report for that day. Teams assigned the same day combine to prepare and present their weather report to the class. Information from all 8 days is then used to forecast the weather for the unknown ninth day. Teaches global patterns of atmospheric movement.
SB46825 – \$58.95

▲ See page 3 for complete Choking Hazard Label Information.

◆ DOT hazardous material ⚠ Subject to DOT hazardous material surcharge.



EXCLUDED FROM DISCOUNTS



Augmented Reality Sandbox
 Uses 3-D visualization applications and a hands-on exhibit that combines a real sandbox, virtual topography and water created using a closed loop of a 3-D camera, powerful simulation and visualization software, and a data projector. Includes 3-D camera, data projector, laptop loaded with visualization software, and instructions. 32"D x 42"W x 85"H (46"D when shelf is up). Sand not included. **SB25175 – \$10,500.00**

BEST SELLER

Water Cycle Model Activity Set
Gr. 5+ This 3-D demonstrator creates a water cycle as it occurs in nature. Model actually causes rain to fall, then evaporate in a continuous cycle. Also graphically shows distillation of water as it changes to gas. Study cards, activity notebook, and full-color overhead transparency.
SB25175 – \$117.50
SA09171 Water Cycle Model Only – \$101.95



BEST SELLER

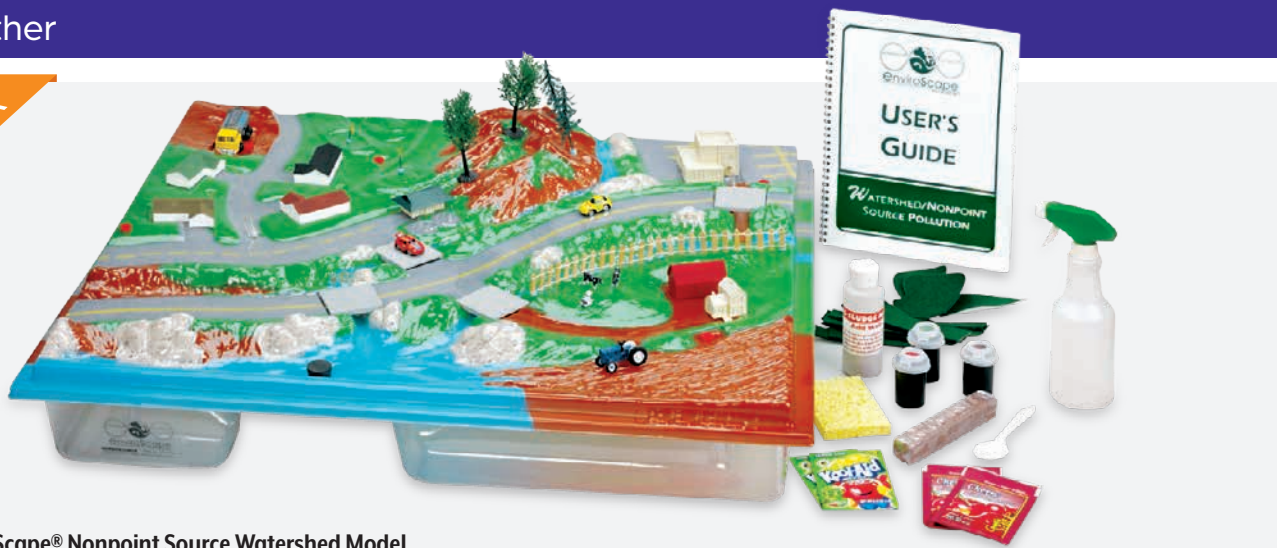

EnviroScope® Nonpoint Source Watershed Model

Teaches the watershed concept as well as point and nonpoint source pollution. Two waterways flow into a larger water body, which is representative of a lake, river, bay, or ocean. Model tracks pollution from various nonpoint sources, including residential areas, forestry areas, transportation, recreation, agriculture, and construction, as well as from industry as a point source. Pollution and runoff are visually apparent when rain falling over landscape top carries soil (cocoa), chemicals (colored drink mixes), and oil (cocoa and water mixture) through a watershed to a body of water. Best management practices include felt buffer strips as vegetation, clay to create berms, and other methods to show conservation and water pollution prevention measures. Unit comes with everything you need to demonstrate the movement of water through a watershed and the pollution that runoff may cause. **CHOKING HAZARD (I).** Not for under 3 yrs. **Z41122 – \$989.00**



Amazing visual aid as warm and cold fronts clash

Density Flow Model

Use scientific inquiry techniques to explore concepts related to geology, meteorology, and fresh and saltwater systems. Flow of brightly colored fluids help students visualize density concepts as they relate to plate tectonics, sea floor spreading, air masses, fronts, air pressure, winds, ocean currents, thermoclines, haloclines, upwelling, El Niño, and more. 75-page manual includes set-up instructions, student activity masters, and answer keys. 44"L x 3¾"W x 6"H. **Z19342 – \$464.95**

Density Flow Model Junior. Like the larger model above, this smaller model is a teacher demonstration apparatus. Includes 64-page manual with instructions, activity masters, and answer keys. 22"L x 3¾"W x 6"H. **Z20652 – \$249.95**

***EXCLUDED FROM DISCOUNTS**



Landform Studies Program

Eight separate landform models form a 3' x 3', three-dimensional model of mountains, lakes, rivers, deserts, glaciers, coastlines, canyons, and cultural points of interest. Students explore coastal plains, canyon lands, fault block mountains, folded mountains, and volcanoes. A lesson plan provides a glossary keyed to features on the models, plus question-and-answer exercises and supplementary activities. **SA05779 – \$350.00**

Sea Floor Simulation Kit

Gr. 6+ Hand-held or submerged seascape model teaches about sea floor topography, sea floor currents, and plate tectonics. When submerged in a 10-gallon tank (not included), model can simulate current movements with colored dye (not included) and create volcanic eruption bubbles with the use of an air pump (not included). Sea floor model (19"L x 9"W x 6"H), air bubble lines with connectors, suction cups, profile-vocabulary decals, and teacher's guide with 4 activities. **SB47450 – \$208.00**



EXCLUDED FROM DISCOUNTS



Wild Weather Poster Series

Dramatic photos depict some of nature's most extreme conditions. Descriptive text provides facts, figures, and scientific background about each weather phenomenon. Set of 8. **SB48563 – \$130.00**



Instant Snow Powder

Demonstrate the super absorbent properties of a polymer while making snow in your classroom that will feel cool to the touch. As the polymer absorbs water, it will expand to over 40 times its original volume. The end result is fluffy flakes of fake snow that won't melt and can be reused again. **NE30203 Bag (400 g) – \$38.50**
NE30204 Bottle (3.5 oz.) – \$13.75

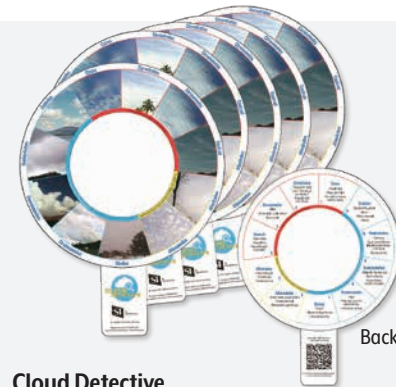

Cloud Detective

Gr. 5+ Identify the different clouds in the sky. Simply hold tool so cloud can be seen through observation hole, then try to match cloud to images on outside of tool. Opposite side contains additional information related to color, shape, and current weather to ensure correct identification. Pkg. of 5. **SB50551 – \$17.95**



Thames and Kosmos® Weather and Climate Lab

Gr. 1-6 Install the 5-in-1 weather station outdoors and use the built-in wind vane, compass, rain gauge, anemometer, and thermometer to measure and track weather data. Explore air current and pressure, ocean currents, the hydrological cycle, and more while building observation and note-taking skills. Manual includes 8 experiments. **NE30501 – \$19.95**



Modeling Convection Currents

Gr. 6+ Students in small groups investigate convection currents in water and develop an understanding of the relationship between water temperature and its movement. Analyze data about the earth's layers and convection currents in the lithosphere. Explains tectonic plate motion. **CHOKING HAZARD (I).** Not for under 3 yrs. **SB45742 – \$116.95**



Laminated Cloud Charts with Weather Forecast

A quick, accurate way to forecast weather. Waterproof chart is used by the U.S. Coast Guard and the FAA. Contains full-color photos with captions. 15" x 18". Laminated. **SB40703 – \$15.95**

BEST SELLER



Modeling Stream Erosion and Deposition

Gr. 6+ Using a mini stream table, students create, observe, describe, and interpret the erosional and depositional patterns created when "rainwater" flows over an area. Features commonly formed include canyons, braided streams, and deltas. For 24–30 students working in groups of 4 or 5. **CHOKING HAZARD (I).** Not for under 3 yrs. **SB44075 – \$224.50**



Groundwater Table

Gr. 5+ Transparent plastic tray can be used on an overhead projector or on a tabletop. Use the included pump to move colored dye throughout the model to demonstrate groundwater concepts such as aquifers, sinkholes, caverns, geysers, and hot springs. Includes self-contained groundwater table, water pump (120V AC), tubing, eyedropper, and teacher's guide. **CHOKING HAZARD (I).** Not for under 3 yrs. **SB46712 – \$179.95**



EXCLUDED FROM DISCOUNTS

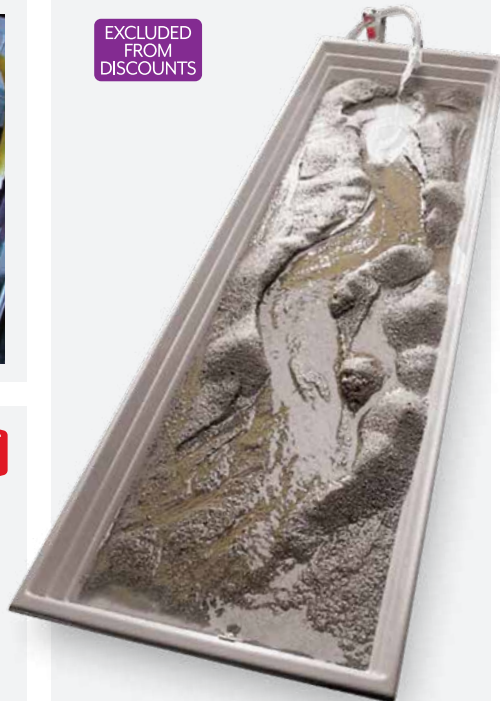

Stream Table Kit

Sturdy plastic tray is large enough for group study or individual investigations. A special trough can be used for relating the rate of erosion to slope and stream volume. **SB01704 – \$101.95**
Set of 4 Kits **SB16231 – \$369.95**

Nasco Soil Erosion Simulator Kit

Introduce students to the science behind soil erosion through simulation. This kit uses hands-on scientific procedures to study soil erosion, how it occurs, and how to prevent it. Teach conservation methods that can be used, natural vs. unnatural erosion, and how soil erosion affects our lives. Kit includes two soil erosion simulator trays, water catch basin, oat seeds, watering cart, two angle ladders, and a guide with assessment questions, follow-up activities, and instructions. **SB45434 – \$109.95**
Potting Soil, 4 qt. KI01037(P) – \$3.95



ONLY AT NASCO

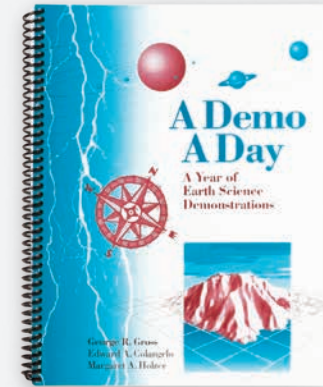

A Demo A Day™ – Earth Science
Gr. 7+ Use demonstrations to introduce a topic, illustrate a point during a lesson, summarize a lesson, or review a concept. 205 pages. **SB43859 – \$48.95**

BEST SELLER

Erupting Volcano Classroom Pack

Gr. 3–8 This four-session project involves students in creating interactive volcanoes that actually erupt. Meets expectations of the NSES for Earth Sciences. For 12 individual or group projects. Teacher and student guides. **SB45529 – \$119.95**



Cross-Section EarthModel

Bring the deep layers of the earth to light. Outside surface of 5" foam model illustrates continents and oceans with raised features. Separate to discover the earth's core. Each brightly colored hemisphere shows layers, temperatures, and depths. Activity/fact guide. **SB40887 – \$19.95**

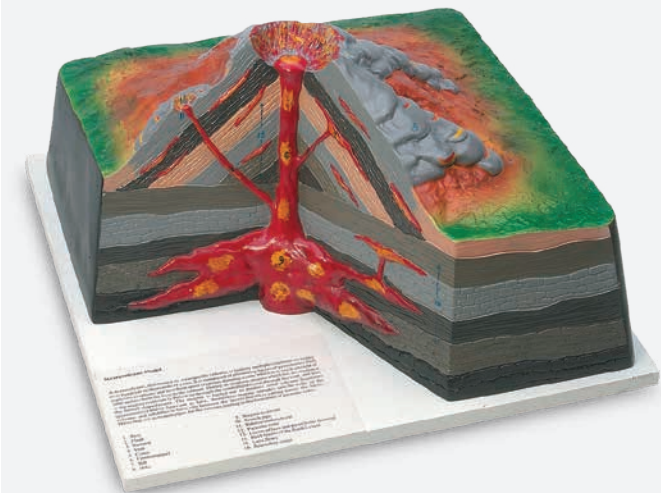

Volcano Model

Gr. 5–9 Detailed stratovolcano and composite volcano model. Illustrates the various crusts, lava tube, volcano formation, and step sided formation of cone shape. 16½"L x 16½"W x 8"H. **SB40678 – \$173.95**

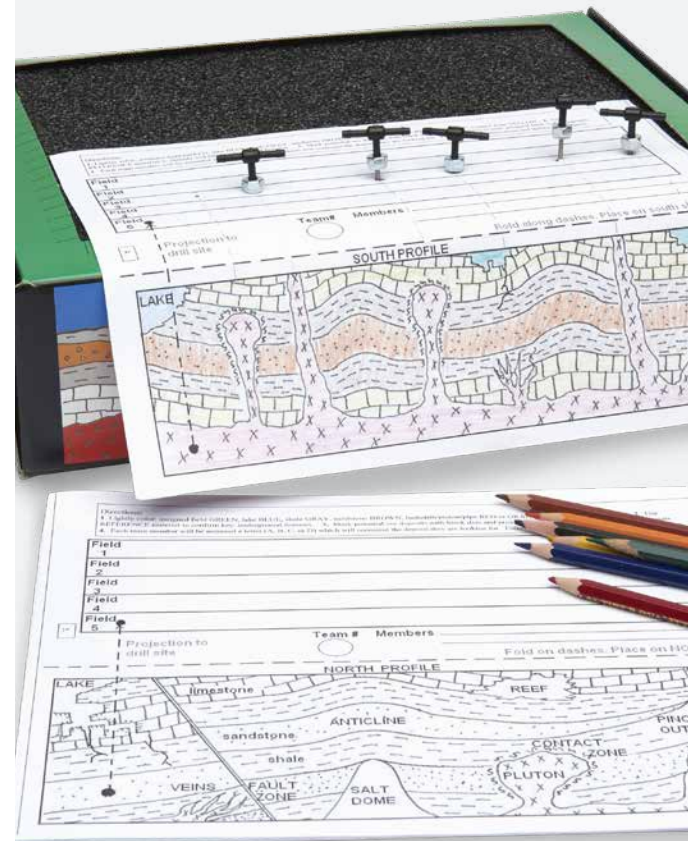

Rock Cycle Resource Kit You Be the Geologist!

Gr. 6+ Provides opportunities for inquiry and developing an understanding of the "dynamic equilibrium" of geologic events. Comes in an interactive box with underground formations displayed on the side and colored clay blocks (representing deposits of gold, oil, etc.) positioned on the inside for students to discover using several scientific techniques. Includes 2 foam boards; hand-held drill rigs; and teacher guide with lab worksheets, reference materials, and activities. 13¾" x 10¼" x 3¾". **SB47449 – \$80.95**

The fun doesn't stop here!
Find more at
nascoeducation.com



Using Remote Sensing to Determine Topography Kit

Gr. 6+ Collect data about concealed landforms, then use it to create visualization of the landforms. Use data to construct a line graph showing a profile across the landform. Teacher's guide and 28 student worksheets and guides. For 24 students. **SB50449** – \$227.95



Earth Processes Poster Series

Gr. 6+ Photos and diagrams introduce students to the fascinating processes that shape Earth's surface. Set of 8; 18" x 24". Laminated. **SB40701** – \$130.00

NEW



United Scientific Earthquake Shake Table

Gr. 7–12 Broad 16" x 16" base has 4 strong springs at the corners and adjustable mountings to hold a variety of model bases up to 12". Two motors are mounted underneath with a protective cage. Motors can be powered individually or together by a 1 to 5 V DC power supply (not included). **NE30524** – \$94.50

BEST SELLER



Making and Interpreting Topographic Maps

Gr. 6+ Hands-on investigation uses the model to construct contour lines and create a topographic map of an area. For 6 groups of 4-5 students. **SB44071** – \$127.95

Compass

Compass with a strong plastic case and clear top. 2" dia. **SB19121** – \$3.95



40 mm Compass

Magnetic compass has clear visibility. Plastic carry case. Pkg. of 20. **SB37264** – \$17.25

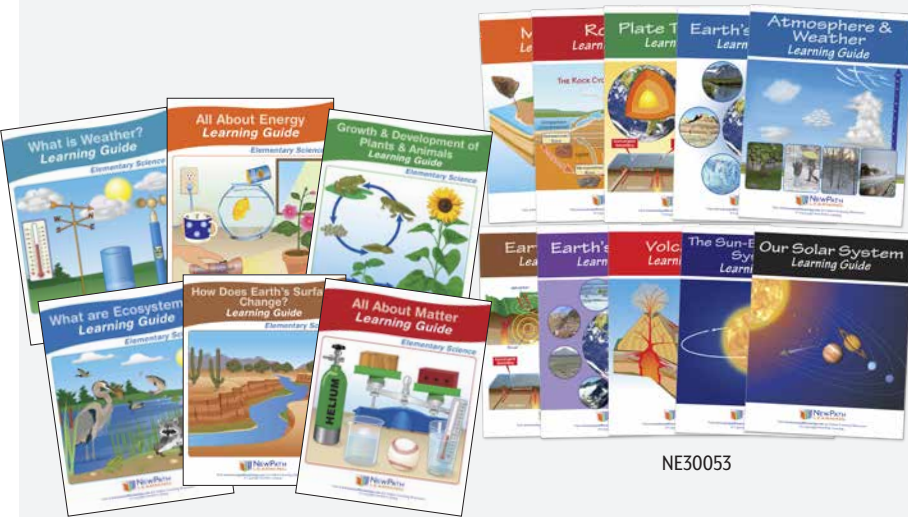

NE30059

NewPath Learning® Earth Science Workbook Sets with Digital Access

These colorfully illustrated workbook sets are perfect for classroom or take-home use. In-depth, interactive lessons are based on NGSS concepts.

36+ pages of self-directed readings in each workbook. Each workbook contains readings, illustrated explanations, guiding questions, a lab investigation, key vocabulary review, and assessments.

One-year, corresponding digital access. Includes animated and narrated tutorials, interactive exercises and activities, virtual labs, online glossary, visual resource library, and an inquiry based student activity guide. Even works with classroom presentations on whiteboard. For complete description of the workbooks with digital access, visit nascoeducation.com.

Gr. 3–5 Set. Includes 6 workbooks.

- Growth & Development of Plants & Animals
- What are Ecosystems?
- How Does Earth's Surface Change?

- What is Weather?
- All About Matter
- All About Energy

NE30059 – \$75.00

Gr. 6–10 Set. Includes 10 workbooks.

- All About Minerals
- All About Rocks
- Plate Tectonics
- Earthquakes
- Volcanoes
- Earth's Surface

- Earth's Atmosphere & Weather
- Earth's Climate
- Our Solar System
- Sun-Earth-Moon

NE30053 – \$129.95



EXCLUDED FROM DISCOUNTS

Tectonics Model Set

Demonstrate plate tectonic principles, plate boundary interactions, and the geometry and relative motions of faulting geologic layers using 3-D manipulative models. Includes 3 geoinformation activities, materials needed to perform the demonstrations, and an access code to download teacher and student guides, videos, geoinformation data sets, and other resource information. **SB53255** – \$203.95



United Scientific Fault Model Set

Gr. 5+ Demonstrate normal faulting, reverse (thrust) faulting, and horizontal faulting with this set of six 3-D models. Includes an access code to download interactive guides, videos, data sets, and more. **NE30301** – \$164.95



United Scientific Mapping Compass

Gr. 5+ Explore the basics of navigation and orienteering in the lab with this compass. Features a sight finder as well as markings in both metric and English scales. Map scale is displayed in mm with a ratio of 1:25000. Detachable lanyard included. **NE30300** – \$12.25



Large Compass

Extra-large magnetic compass in a plastic case with clear top. 3½" (90 mm) dia. **SB33394** – \$6.95



Field Orienteering Map Compass

Liquid-filled chamber stabilizes needle quickly and cushions against impacts. Compass and scale have luminous points. 1¾" dia. compass mounted on clear plastic base (5½" x 2½"). Graduated 0° to 360° scale in 2° increments has a declination correction scale. Base has built-in magnifier, 4 stencils, and lanyard. **SB47544** – \$7.95

Suunto Compass Instruction Kit

Compasses made of clear, scratch-resistant acrylic feature snap-lock lanyard. Ergonomically designed to fit into palm of hand. Instructional compass is larger for group use and has manually manipulated moving parts. 30 compasses (2¾" x 3½"), instructional compass (1¼" x 8"), and carry case. **PE05278** – \$509.95





Write-On/Wipe-Off Giant World Map
Giant, 8' 8"H x 13' W world map comes in 8 easy-to-hang panels. Provides information on world time zones, political boundaries, land elevation, distances and topography, ocean depths and shipping lanes, nautical miles, longitude and latitude, and major cities. Use dry-erase markers on write-on/wipe-off surface (includes red dry-erase marker). Trim to fit any walls. Easy to remove without damaging walls. Current as of 2015.  **SB29793 — \$199.95**



A. The Pioneer Globe
12" political globe with mounting that swings up and down for better viewing. Thousands of place names. Raised relief. 16½"H. **SB16464 — \$85.50**



F. Laminated Poster Map Set
Large scale political poster maps in bright colors and easy-to-read type can be marked. Laminated. 49" x 33". Includes 1 of each map below. **SB52652 — \$53.95**
U.S. Map. Shows interstate highways, cities, capitals, rivers, places of interest, and more. **SB49728 — \$34.95**
World Map. Country locator lists every country in the world by latitude and longitude. **SB49729 — \$34.95**



B. Land Cover Writable Globe
Raised-relief globe shows cropland, natural vegetation, landforms, and water features that make up Earth's landscape. Features detailed relief shading along with political boundaries and names. Writable. 12". **SB48527 — \$168.95**

Writable surface



C. Adventurer Globe
12" political globe features raised-relief, blue ocean ball with distinctive colored boundaries; easy-to-find geographic locations; and a plastic base. 16"H. **SB39256 — \$54.95**

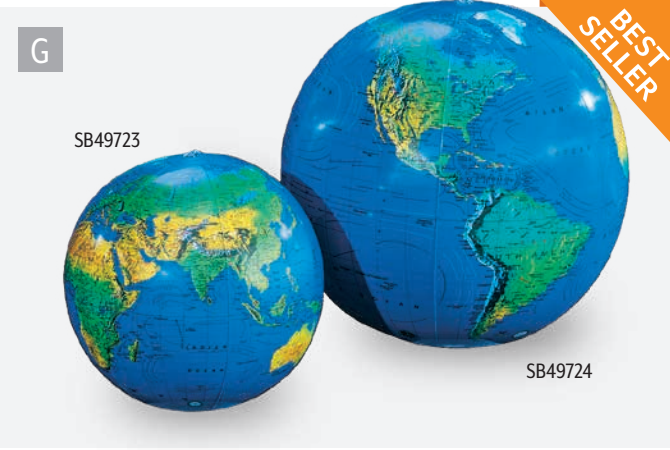

G. Topographical Inflatable Globes
Beautiful physical globe that shows the Earth with natural topographical covering. **SB49723 12" Globe — \$10.95**
SB49724 16" Globe — \$12.95

BEST SELLER



H. Apollo Globe
Bright, contrasting colors with thousands of place names. Easily remove from or place on base for close-up viewing. 9" dia. x 12"H. **SB49731 — \$39.95**



D. The Atlantis Globe
12" world ocean globe in raised and indented relief on Gyro-Matic mounting with numbered full meridian. Land areas in true-to-life colors to illustrate mountains, deserts, forests, and grasslands. Oceans show undersea physical features. 16½"H. **SB16465 — \$105.00**



E. Day/Night Globe
Shows the striking colors of a blue ocean political map when not lit. Turn light on and witness how the sky changes at night as it transitions into a night globe naming and depicting 88 constellations and more than 35 of the brightest stars. Corded. 16½"H x 12" dia. **SB50412 — \$99.95**



I. Terrene Globe
Blue political globe lights up. 6" dia. x 8½"H. **SB50411 — \$35.95**

Keep exploring at nascoeducation.com

BEST SELLER



Classroom Collection of Rocks and Minerals

Basic study in mineralogy and general geology in rock-forming minerals; igneous, sedimentary, and metamorphic rocks; ores of common metals; gemstones; and minerals in the scale of hardness. 50 numbered 1" specimens, compartmented container, and study guide.
SB46077 — \$64.95



Rock Collection

Includes 5 each of igneous, metamorphic, and sedimentary rocks, including obsidian, granite, basalt, scoria, rhyolite, sandstone, limestone, shale, travertine, conglomerate, slate, marble, quartzite, gneiss, and amphibolite. 15 numbered 1½" specimens in a compartmented container.

SB10942 — \$28.95

Rock Study Kit

Includes 5 each of igneous, sedimentary, and metamorphic rocks; guide; and magnifying glass.

SB39180 — \$23.95



Rock Collection Set #1

Set of 9 (basalt, obsidian, pumice, shale, sandstone, limestone, marble, gneiss, slate) in a 4" x 7" cardboard box with a partitioned plastic tray. Each one is 1" to 1½".

SB41176 — \$13.95



Rock Collection

Sedimentary, metamorphic, and igneous rocks in a solid storage box.

⚠ CHOKING HAZARD (1). Not for under 3 yrs.

SB47390 — \$20.95



Rocks, Minerals, and Fossils of the U.S.A. Collection

Representatives of rocks, minerals, and fossils of the U.S. that are either mined for economic value or are commonly found in the state listed. Some minerals and fossils have been deemed a "State Gem" or "State Fossil," which is noted, as well as other facts. 50 numbered specimens (approximately 1" x 1") in a compartmented container.

SB46093 — \$54.95



SB10943

Igneous Rock Collections

Representative specimens of intrusive and extrusive igneous rocks. Materials provide a basis for understanding geologic processes at work in the earth.

Demonstration. 15 numbered 1½" specimens in a compartmented tray.

SB10943 — \$23.50

Classroom. Smaller samples of specimens above. 100 pieces total.

SB50622 — \$10.95



Mineral Study & Test Kit

Gr. 5+ Learn to identify 15 common minerals by observing and testing physical properties. Includes activity guide, magnifying glass, streak plate, and nail.

SB37929 — \$22.95



Hardness Scale with Test Kit

Includes 9 minerals used in Mohs' scale, streak plate, glass plate, nail, and identification key in a polystyrene tray with lid.

SA02792 — \$16.95



SB10945

Sedimentary Rock Collections

Contains representative sedimentary end products.

Demonstration. 15 numbered 1½" specimens in a compartmented container.

SB10945 — \$23.50

Classroom. Smaller samples of specimens above. 100 pieces total.

SB50623 — \$12.95



SB10944

Metamorphic Rock Collections

In geologic processes usually associated with pressure and heat, rocks may reform to become new metamorphic rocks.

Demonstration. 15 numbered 1½" specimens in a compartmented container.

SB10944 — \$23.50

Classroom. Smaller samples of specimens above. 100 pieces total.

SB50624 — \$10.50

Test minerals you have in your lab



Mineral Test Kit

A great kit in case you have minerals available already. Includes a streak plate, glass plate, hand lens, dropper bottle, magnet, nail, penny, hardness scale, and zip closure bag.

SB48163 — \$12.95

BEST SELLER



Mineral Test Kit with Minerals

Gr. 4+ All the tools necessary for rock, mineral, and fossil identification. Minerals include muscovite, hematite, quartz, magnetite, calcite, talc, gypsum, microcline, and pyrite.

SB48458 — \$16.95

BEST SELLER



Rock Cycle Activity

Gr. 6+ Playing in groups of 4, students record what happens to their set of igneous, sedimentary, and metamorphic rocks. Detailed student sheet guides students on how to use results to describe the rock cycle. Includes 8 sets of the game so the entire class can play simultaneously. **⚠ CHOKING HAZARD (1).** Not for under 3 yrs.

SB40668 – \$152.00



Professional Rock Tumbler

12-lb. capacity tumbler with rubber hexagon barrel for quiet operation. Overload protected, fan-cooled motor. 115V, .67 amps, 1/5-hp motor.

9703319 – \$284.95

Grit Pack. 1-lb. coarse, 1-lb. fine, 1/2-lb. pre-polish, and 1/2-lb. polishing grit.

9703424 – \$35.95



For UV lights, visit nascoeducation.com

Fluorescent Minerals Collection – Longwave and Shortwave

Illustrates the response of certain minerals to UV radiation. 15 numbered specimens (1 1/2") that correspond to key.

SB09563 – \$49.50



Rock Specimen Storage Box

Create your own collection with this 17-bin, clear storage container (rocks not included).

9721278 – \$7.00



See pp. 160–161 for more safety goggles

Soft Vinyl Impact Goggles

Goggles mold to all faces comfortably. May be worn over prescription glasses. Frame perforated for full ventilation. Large polycarbonate lens offers wide vision. Meets ANSI Z87.1 standards.

SB25323 – \$2.45



Classifying Sedimentary, Igneous, and Metamorphic Rocks

Gr. 6+ A reading on the formation of igneous, sedimentary, and metamorphic rocks supplements student observations as they examine, describe, and group rock samples. Samples are 1" x 2" x 1" or larger and show characteristics of each rock type. Student worksheets. Materials for 32 students. **⚠ CHOKING HAZARD (1).** Not for under 3 yrs.

SB40664 – \$169.00



Mineral ID Kit with Sort Cards

Gr. 4–12 Get students started on their earth sciences journey with this mineral identification kit. Kit includes: 20 mineral specimens, sort cards, magnet, magnifier, streak plate, nail, ID list, and segmented storage tray.

NE30087 – \$99.95



Glass Plates

Thick, 1/4" glass plates for hardness testing of rocks and minerals. Pkg. of 10. 1" x 2".

SB14188 – \$17.95



Streak Plates

Unglazed porcelain tiles for streak testing of rocks and minerals. Pkg. of 10. 2" x 2".

SB14187 – \$9.95



Black Streak Plate

Unglazed black porcelain tiles are ideal for streak testing of light colored minerals. Pkg. of 10. 1" x 2".

SB26433 – \$14.95

Build your wish list and email it at nascoeducation.com

Nasco Fossils Paper Casting Classroom Kit

Create inexpensive paper casts of fossils, decorate them with markers, then use the reference guide to determine which animal the fossil represents and learn interesting facts about it. Kit includes 6 molds to make a total of 12 different fossils, 3 spray bottles, 18 washable tempera paint markers (3 each of 6 colors), 3 books, and activity guide. **SB44733 – \$164.95**



ONLY AT NASCO

Nasco Fossil Molds

Soft, flexible molds create exact fossil replicas: fish from 40 million years ago; gastropod from 65 million years ago; cephalopod from 100 million years ago; pectopteris, annularia, neuropteris, and lepidodendron from 300 million years ago; crinoid, brachiopod, and bryozoa from 450 million years ago; horn coral from 400 million years ago; and trilobite from 500 million years ago. Set includes 6 molds (some molds have more than 1 fossil), 5 lbs. of casting plaster, and molding instructions. Not for use by children without adult supervision. **SA04671 – \$99.95**

Nasco Casting Plaster. 5-lb. package. Not for use by children. **9730282 – \$21.00 24+ \$18.22**



ONLY AT NASCO



Polished Amber with Ancient Insects
Each piece of polished amber contains at least one prehistoric insect. Sizes vary. **SB28498 – \$14.05**

BEST SELLER



Examining Fossils Kit
Gr. 6+ Examine 8 different fossils from various localities and geological ages. See the power and limitations of using fossils as evidence of past life and as bases for determining evolutionary relationships. Introduces the geological time scale. Reusable. For up to 32 students. **SB40670 – \$202.95**

BEST SELLER



Fossil Starter Bag
Gr. 5+ Includes 15 individually bagged and labeled fossil specimens commonly used in classrooms to illustrate major life forms through history. Teacher's insert describes each fossil. Also includes full-color geologic time student chart. **SB48142 – \$14.95**



Fossil Hunt Kit
Gr. 6+ Students learn to identify different fossils after digging them out of a gravel mixture. 1-lb. bag of gravel mixture with 12 real fossils (two each of six types) and corresponding large identified specimens, magnifier, forceps, and teacher's guide in storage box. **SB33401 – \$28.00**



Evolution: Examining Fossil and DNA Evidence
Gr. 6+ Use whale fossil records to support the theory of evolution. Compare DNA from a number of vertebrates. Teacher's guide, 28 student worksheets/guides, 12 sets of 5 skeleton cards, 12 whale fossil charts, 12 mysticetes skeleton cards, 12 sets of 5 DNA cards, and 3 transparencies. For 24 students. **SB51696 – \$81.95**



Fossil Collection
Vertebrate and invertebrate fossils from the Paleozoic, Mesozoic, and Cenozoic eras are included. 15 numbered specimens. **SB10961 – \$28.95**



Advanced Fossil Collection
Includes demonstration specimens of animal phyla and plants. 30 numbered specimens in a compartmented container. **SB10963 – \$44.95**

SPACE SCIENCE

Help your students reach for the stars by exploring space science. All they need are the tools and resources to expand their understanding of astronomy concepts and open their world to new possibilities.

Astronomy 204-209

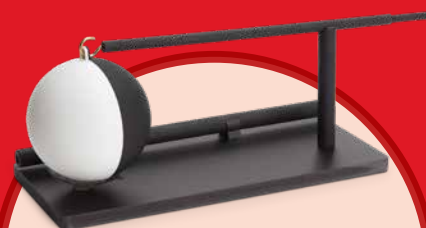

Moon Phaser
Gr. 3+ Provides practical information on teaching lunar motion and the phases of the moon. Full description found at nascoeducation.com.
SB34839 – \$126.95

BEST SELLER

Moon Phase Classroom Inquiry Set
Gr. 6+ Includes 6 moon-earth-sun globe sets and teacher's guide. Accompanying CD-ROM includes pre-assessments, SMART Board™ activities, vocabulary, extensions, and final assessments.
SB49076 – \$184.95

Phases of the Moon
1 New 2 Waxing Crescent 3 First Quarter 4 Waxing Gibbous 5 Full 6 Waning Gibbous 7 Last Quarter 8 Waning Crescent

Nasco Moon Phases Posters
8 phases of the moon. Laminated card stock.
28" x 8" SB37751 – \$14.95
96" x 18" SB49897 – \$39.95

ONLY AT NASCO

Official NASA Moon Globe
Gr. K-12 Extraordinary 12" dia. globe depicts the geographical features of Earth's moon, including craters, "seas," and mountain ranges. NASA approved. 15".
SB36728 – \$97.95

Moon Phases Cling Activity Set
Gr. 2-5 Help students understand the phases of the moon using this interactive cling set. Includes 25" x 18" moon phases cling sheet, 12" x 27" black cling board, wet-erase marker, and instruction sheet.
SB44373 – \$29.95

Moon Phase Demonstrator
Gr. 7+ Show how the moon's appearance changes over a one-month period. Select a phase of the moon by turning the front disc. Earth's rotation is simulated by rotating the discs together from sunrise to sunset, illustrating the relative paths of the sun and moon. Rear disc is screened with a visualization of the perceived shape of the moon throughout the lunar cycle.
SB48259 – \$45.95

The Planets Learning Posters Set
Gr. K+ Bring space discovery to life in the classroom with this set of engaging and educational posters. Reinforce science lessons with images of the eight planets of the solar system along with interesting facts. Set of 8; 10 3/4" x 16 1/8" each.
NE30238 – \$15.95

3-D Solar System™
Gr. 5+ Turn the lights off for an amazing display of the solar system with glow-in-the-dark components. Includes 8 planets, Pluto, over 200 adhesive stars, string, putty, and a guide. **CHOKING HAZARD (1).** Not for under 3 yrs.
SB49325 – \$21.95

Introduce young explorers to new views

Make-Your-Own Telescope Kit
Great choice for art, science, or STEM/STEAM units. Kit includes enough materials for 12 cardboard telescopes. Includes easy-to-follow instructions and stickers for decorating. Incorporate discussions about light, mirrors, or the solar system. 10"L x 2 1/2" x 2 1/2".
NE20043 – \$55.95

Nasco Space Bingo
Gr. 5+ Game takes you to the outer reaches of the solar system as students learn basic astronomy terms. 30 playing cards (5" x 6"), 100 vocabulary cards, master word list, directions, and plastic markers.
SB48565 – \$21.95

ONLY AT NASCO

Inflatable Solar System
Gr. K-12 Realistic-looking set teaches size and distance relationships of planets, the moon, and the sun; as well as rotation, revolution, and orbit. 23" sun and proportionate planets and moon with sizes ranging from 5"-23". Includes a foot pump, teacher's activity guide, and hooks for easy hanging. Deflate for easy storage. **CHOKING HAZARD (1).** Not for under 3 yrs.
SB37813 – \$49.95

Orbiting Solar System Kit
Gr. 1+ Build a mechanical model of our solar system, wind it up, and watch the planets revolve around the sun. Learn about the planets' relative sizes, orbits, and appearances, as well as fundamental gear mechanics. Includes 28 pieces and 8-page illustrated guide.
NE30119 – \$29.95

Planet Poster
Shows the correlated distance between the sun and planets, as well as the size of each and explains each planet's year length, rotation period, and number of moons. Dwarf planets, including Pluto, are also featured. 18" x 24". Laminated.
SB42980 – \$20.95

See page 3 for complete Choking Hazard Label Information.



Trippensee® Hand-Driven Illuminated Planetarium Model

Shows synchronized motions of Venus, Earth, moon, sun, and other planetary phenomena, including all the important Earth/moon/sun relationships. Light is used to illustrate lunar, solar, and annular eclipses; phases of the moon; and areas of day, night, and twilight.

SBI5349 — \$515.00



Celestial Star Globe

Gr. 6–12 This model shows the apparent positions of the stars visible from earth. The 3D representation allows the relative angular positions of the constellations to be visualized and permits students to estimate which stars will be visible from different places on earth for any rotational position of the planet. The globe consists of two concentric spheres mounted on a common axle.

NE30127 — \$104.95



Thames & Kosmos® Planetarium Projector

Projects astronomically accurate maps of stars for the northern and southern hemispheres, planets, space objects, and extra-galactic phenomena. Includes 2 projection domes, educational poster, instructions, 32 images with storage, and USB cable. Timed shutoff and long-lasting LED lights.

NE30398 — \$34.95

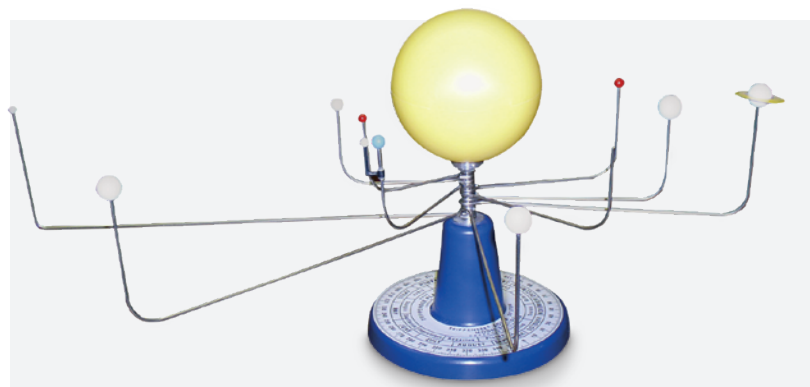

Trippensee® Solar System Model

Copernican heliocentric solar system illustrates the motions of the planets, their relative sizes, and their relative distances from one another. All stainless-steel wire arms. Includes 10 orbits (8 planets, moon, and asteroid belt), instruction book with diagrams, and activities.

SBI5350 — \$129.95

Light up the night sky for a closer look at the stars



The Constellation Globe

Turn the light off and brilliant lithography on the two-way illuminated globe delineates the firmament's stars, constellations, and nebulae; turn the light on and witness the luminous beauty of over 70 celestial images. 12" dia. x 16".

SB28577 — \$94.95



Roylco® Constellation Cards

Gr. PreK+ Teach students how to recognize star patterns in the night sky. Made from durable, tear-resistant material and die-cut with astronomically correct constellations. Includes 54 cards and a full-color poster guide.

NE30376 — \$28.99



BEST SELLER

Trippensee® Lighted Basic Planetarium Model

Lighted planetarium featuring chain and sprocket drive, sturdy plastic arm with compass for locating North Star, Earth globe with map, and moon globe movable to any position. Base dial marked with seasons, months of the year, and signs of the zodiac. Light illustrates solar and lunar eclipses and the phases of the moon. Instruction book with diagrams. Sun (6" dia.) and Earth (3" dia.) on a 13" arm. 12" x 22".

SBI5348 — \$210.00

S00562 Unlighted Model — \$185.00



BEST SELLER

Explore seasons, eclipse phases, and moon phases

Earth Sun Planetarium

Gr. 6–12 Demonstrate the rotational motion of earth on its axis, its orbit around the sun and the revolution of the moon with this high quality model. As the sun casts a beam of light onto earth (via an embedded LED), users can easily manipulate the positions of each body to examine how their dynamics correspond to seasons, eclipses and lunar phases. 18" x 12".

NE30105 — \$72.50



Pack of 10

United Scientific Solar Eclipse Glasses - 10 Pack

Specially designed lenses conform to and meet the Transmission Requirements of ISO 12312-2, Filters for Direct Observation of the Sun, as well as the Transmission Requirements of EN1836:2005+A1:2007(E) for an E15 Filter for the Director Observation of the Sun and the Transmission Requirement AS/ NZS 1338.1:2012, Filter for Eye Protectors. Frame includes safety information and instructions for use. Pack of 10.

NE30496 — \$11.95



The Sunspotter™

Safely track sunspots as they appear, move, and vanish. By using a series of mirrors, a bright 3" solar image is projected onto a white viewing screen by a powerful 62 mm dia. objective lens. Eliminates the need for telescopes, solar filters, and tripods. Wooden, folded-Keplerian telescope provides a much safer and convenient way to view the brilliant light of the sun compared to more common methods.

SB46150 — \$525.00

EXCLUDED FROM DISCOUNTS



Celestron® Powerseeker 50AZ Telescope

Refractor-style telescope with 24" optical tube and 2" (50 mm) aperture. Quick and easy setup requires no tools. Slow motion controls for smooth tracking. Erect image optics are ideal for terrestrial and astronomical use. Fully coated glass optical components with high transmission coatings for enhanced image brightness and clarity. Comes with three eyepieces (30X, 50X, and 150X). 3X Barlow lens triples the magnifying power of each eyepiece. Highest useful magnification: 118X. Includes accessory tray, aluminum tripod, and a bonus astronomy software download with a 10,000-object database, printable sky maps, and 75 enhanced images. Two-year warranty.

SB52509 — \$63.95

Celestron® Upclose Porro Binoculars

High-quality and water-resistant. Multi-coated optics increase light transmission, resulting in brighter and sharper images with high contrast levels. Rubber-covered aluminum body protects from rough handling. Ergonomic thumb indents and finger ridges for extra nonslip comfort and ease of use. Includes binocular straps and soft carrying case. Limited lifetime warranty.

7 x 35 Binoculars. 7X magnification. SB52513 — \$43.95



10 x 50 Binoculars. 10X magnification. SB52514 — \$47.95

EXCLUDED FROM DISCOUNTS



Celestron® Firstscope Telescope

High-quality, Dobsonian-style stand with a 3" (76 mm) aperture reflector optical tube make this scope an ideal entry level astronomical telescope. Portable and light-weight tabletop design makes it easy to store, transport, and setup. Easy to use — simply navigate night sky by moving tube in direction of desired object. Comes with two eyepieces (15X and 75X). Highest useful magnification: 180X. Two-year warranty.

SB52508 — \$85.95

A. Thames & Kosmos® Telescope

Explore the Earth, Moon, and planets with a refractor telescope that offers 100x magnification. High-quality glass optical lenses, dew shield, finderscope, compass, tripod, mirror, dust covers, and instruction manual.

NE30403 — \$49.95

B. Celestron® StarSense Explorer LT 80 Refractor Telescope

Gr. 9+ StarSense Explorer is the first telescope to use a smartphone to analyze the night sky and calculate its position in real time. Highest useful magnification: 189X. Includes 80 mm refractor optical tube with fully coated glass optics, StarSense smartphone dock, 10 mm and 25 mm eyepieces, 2X Barlow lens, 90° erect image diagonal, StarPointer red dot finderscope, altazimuth mount, and full-height, adjustable tripod.

NE30437 — \$229.95

C. Celestron® StarSense Explorer DX 130 Reflector Telescope

Gr. 9+ StarSense Explorer is the first telescope to use a smartphone to analyze the night sky and calculate its position in real time. Highest useful magnification: 307X. Includes 130 mm reflector optical tube with fully coated glass optics, StarSense smartphone dock, 10 mm and 25 mm eyepieces, StarPointer red dot finderscope, altazimuth mount, and full-height, adjustable tripod.

NE30438 — \$479.95

D. Celestron® PowerSeeker 60AZ Refractor Telescope

Gr. 9+ The PowerSeeker 60AZ is perfect for celestial and terrestrial viewing on the go! Highest useful magnification: 142X. Includes 60 mm refractor optical tube with fully coated glass optics, 20 mm and 4 mm eyepieces, 3X Barlow lens, 1.25" erect image diagonal, finderscope, altazimuth mount, adjustable tripod, and Celestron Starry Night software.

NE30439 — \$94.95

E. Celestron® PowerSeeker 70EQ Refractor Telescope

Gr. 9+ Start observing the night sky in minutes with the PowerSeeker 70EQ! Highest useful magnification: 165X. Includes 70 mm refractor optical tube with fully coated glass optics, 20 mm and 4 mm eyepieces, finderscope, manual equatorial mount, adjustable tripod, and Celestron Starry Night software.

NE30440 — \$169.95

Celestron® EclipSmart Solar Filters

Turn your Celestron telescope into a solar scope for viewing the sun and eclipses. A solar filter offers the ultimate protection from harmful solar radiation, including IR and UV light, plus 99.999% of visible light.

F. NE30441 For StarSense Explorer LT 80 — \$31.95

G. NE30442 For PowerSeeker 60AZ — \$28.95

H. NE30443 For PowerSeeker 70EQ — \$31.95

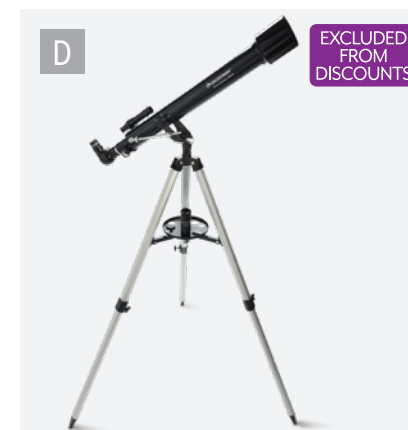
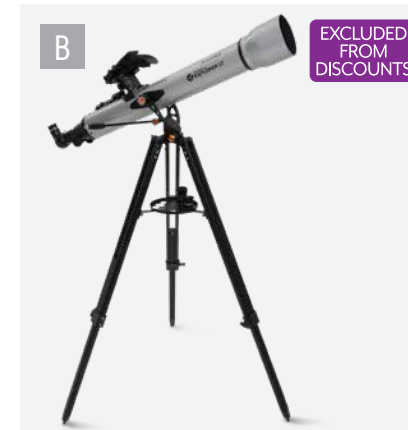
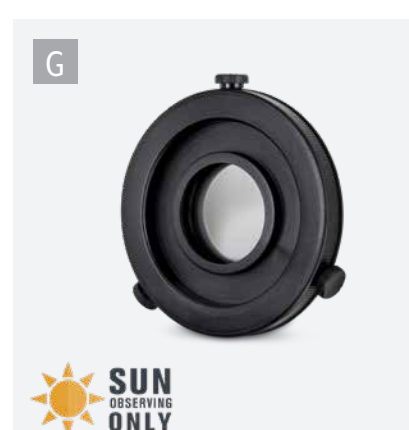
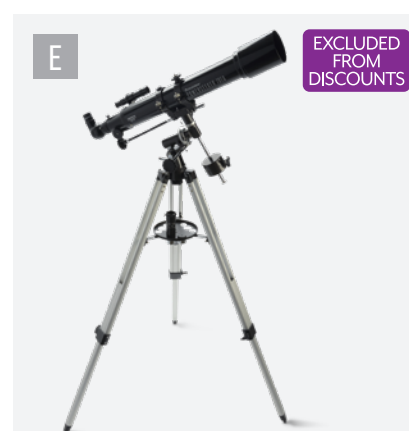
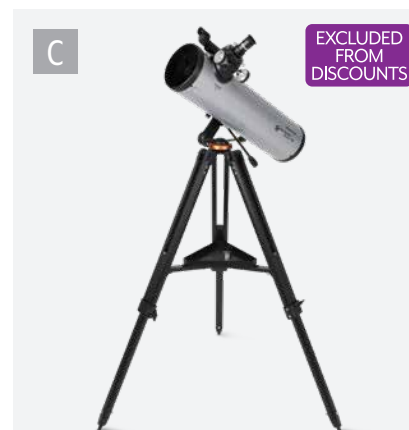

EXCLUDED FROM DISCOUNTS

EXCLUDED FROM DISCOUNTS

EXCLUDED FROM DISCOUNTS

EXCLUDED FROM DISCOUNTS



PHYSICAL SCIENCE

Physical science encourages your students to ask questions about the basic principles that govern the world around us.

They will find the answers to those questions by exploring gravity, motion, energy, speed, friction, balance, optics, solar and wind power, and more.

- Rocketry **210–213**
- Forces & Motion **214–224**
- Alternative Energy **225–229**
- Liquid & Gas **230**
- Density & Heat **231–233**
- Light & Color **234–239**
- Sound & Energy **240–242**
- Electricity **243–252**
- Electromagnetism **253**
- Magnetism **254–257**

Model Rocket Engine Bulk Packs
Everything needed to prepare rockets for flight: 24 rocket engines, 30 model rocket igniters, 24 reusable igniter plugs, and 75 squares (11.4 cm/4½") of recovery wadding. Cannot be shipped by air.

Quality-tested, green label, single-stage engines for high-performance flights. They deliver a smoke trail for easy tracking, and supply ejection power for the recovery system for your rocket's safe return. Total impulse is tailored to fit the various NARFAI classes. Designed for specific launch and flight functions; rocket engines are not reusable.

Code designation stamped on the engine gives useful and important information on its performance capabilities.

- Indicates total impulse or total power produced by the engine
- Shows the engine's average thrust in Newtons and helps you choose the right engine for your rocket's flight
- Gives delay in seconds between burnout and ejection charge

Product No.	Engine No.	Total Impulse			Max. Lift Wt.	Max. Thrust Lb./N	Price Per Pkg.
		Lb.-sec.	N-sec.	Time Delay (±15%)			
◆ SB22587	A8-3	0.56	2.50	3 sec.	85 g	2.4/10.7	\$79.99
◆ SB22589	B6-4	1.12	5.00	4 sec.	113 g	2.2/12.1	\$90.95
◆ SB37350	C6-5	2.25	10.00	5 sec.	113 g	3.4/15.3	\$100.00



Estes® AVG Bulk Rocket Pack
Includes 12 rockets: 4 intermediate-level Alpha (1000 ft.), 4 intermediate-level Viking with 48 fin combinations (1600 ft.), and 4 beginner-level Generic E2X (1325 ft.). Rockets include easy-to-assemble, pre-colored parts. Engines and other additional parts needed for launch sold separately. See details online.
NE30604 – \$99.99



Estes® Designer's Special Flying Model Rocket Parts
Includes more than 100 parts and enables your students to build up to 8 complete model rockets with parts left over. See online for complete list.
NE30607 – \$95.99



Estes® Tri-Flyer Flying Model Rocket STEM Kit
With three fin shapes and two engines included, this kit offers an introduction to the world of aerospace engineering. User-friendly assembly process and a reliable launch system. Included booklet features 5 STEM activities. Includes everything you need for 2 launches with additional consumables sold separately.
◆ NE30606 – \$69.99



Estes® Astrocam® Flying Model Rocket Kit
Equipped with a high-definition digital video camera that can capture audio and video from 900 feet in the air. For specifications, visit nascoeducation.com.
NE30602 – \$54.99



Reach new heights with rocketry bulk packs

Selecting the right kit for your class is now simpler and more economical. Each bulk pack contains enough parts to build 12 flying rockets. Bulk packs feature:

- Great savings – save money since the cost per kit is dramatically reduced
- Kits that are best suited to your needs
- Convenience – control in distributing individual parts to your students during construction

Product No.	Description	Skill Level	1st Flight Engine	Other Engines	Maximum Altitude	Dimensions H x Dia.	Each
A. SB22593	Alpha III® Bulk Pack: Great choice for beginners. Easy No painting required.	E2X – Very Easy	A8-3	B6-4 C6-5	1,100'	12¾" x 1½"	\$145.00
B. SB23833	Generic E2X® Bulk Pack: Plain white so that each student can decorate their own rocket.	1 – Easy	A8-3	B4-4 C6-5	1,110'	15" x 1½"	\$130.00
C. SB22598	Alpha® Bulk Pack	1 – Easy	A8-3	B6-4 C6-5	1,000'	12¾" x 1½"	\$145.00
D. SB41141	Big Bertha® Bulk Pack	1 – Easy	B6-2	B4-4 B6-4 C6-5	500'	24" x 1½"	\$300.00
E. SB39368	Baby Bertha™ Bulk Pack: Miniature version of Big Bertha®.	1 – Easy	A8-3	B6-4 C6-5	575'	12¾" x 1½"	\$165.00
F. SB38634	Hi-Flier® Bulk Pack	1 – Easy	A8-3	B4-4 B6-4 C6-5 C6-7	1,690'	12" x ¾"	\$130.00
G. SB22596	Wizard® Bulk Pack: Laser cut balsa. One of the highest performing rockets, featuring a bright orange streamer recovery system.	1 – Easy	A8-3	B4-4 B6-4 C6-5 C6-7	1,600'	12" x ¾"	\$90.95
H. SB22597	Viking™ Bulk Pack: Painting of item is required. Great first or second model. Can be built with 3, 4, or 5 die-cut fiber fins.	1 – Easy	A8-3	B4-4 B6-4 C6-5 C6-7	1,470'	12½" x ¾"	\$95.00

All starter sets require "AA" alkaline batteries (SBI0916, see p. 212). Engines and flight supplies are not included. They are available on p. 210.

NEW

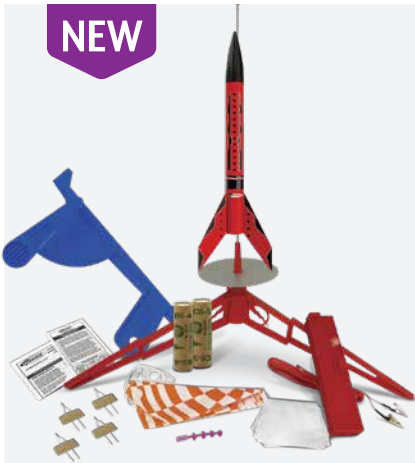

Estes® Rocket Science Flying Model Rocket Starter Kit

Includes everything needed for launch, including multiple engines and launch and recovery system. Reaches up to 1,100'. Experiment with different engines and observe reactions. Measure and track rocket's progress with the included Mini AltiTrak altitude tracker.

Specifications:

- Length: 12.6 in. (32 cm)
- Diameter: 0.98 in. (25 mm)
- Weight: 1.2 oz. (34 g)
- Fin material: molded plastic

◆ NE30603 — \$49.99



Tech-Pak™ Rocket Kit — Skill Level 2

Gr. 5+ Build rockets from scratch with the kit contents and a piece of notebook paper. Students roll their own body tube and complete the rocket with Estes® components. Pkg. of 12. Recommended engines: A8-3, B6-4, and C6-5 (not included, see p. 210).

SB26227 — \$165.95

NEW



Estes® Rocket Stability Kit

With the included lesson plan, students attempt to build a stable rocket and test it with the rocket holder. Provides enough supplies for groups to build 2–3 rockets with 108 rocket configurations to explore and improve upon.

NE30608 — \$29.99

Porta-Pad® II Launch Pad and Electron Beam® Launch Controller

Launches all mini-, standard- (A–C), and D-powered rockets. Launch Pad comes complete with blast deflector, standoff stem, 2-piece 1/8" launch rod, and launch rod cap. Launch direction may be adjusted 30 degrees from vertical and can accommodate a 3/16 in. Maxi Launch Rod (sold separately). Requires 4 new 1.5V AA alkaline batteries (sold separately).

NE30609 — \$39.99

NEW

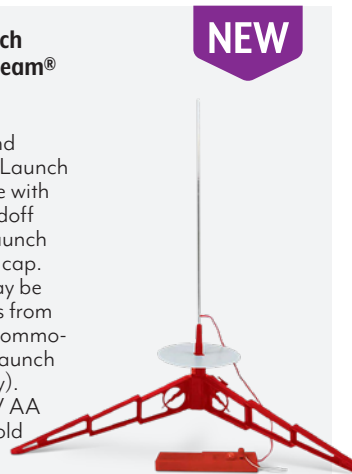

AltiTrak® — Altitude Finder

Track your rocket to the top of its flight, then instantly lock in its altitude. Displays exact altitude on metric scale. Precision-made of plastic. Easy to assemble. Includes conversion table for calculating altitude.

SB01216 — \$23.99



Electron Beam® Launch Controller

Safety key, arming light, and launch button for total launch control. Plastic. 15' of launch wire with pre-soldered micro-clips.

SB14937 — \$29.99

Size "AA" Batteries. Pkg. of 4. SB10916 — \$1.75

NEW



Estes® Mini AltiTrak™ Altitude Trackers

Small, easy-to-transport altitude tracking devices allow students to track, analyze, and graph flight data to understand what is truly happening when their rocket flies through the air. Pack of 3.

NE30605 — \$11.99

Porta-Pad® II Launch Pad

May be used with any Estes® launch controller to launch any Estes® rocket. Easy to set up; quick to take down. Adjustment for air direction cannot be tilted more than 30° from vertical. Steel blast deflector plate and 36" x 1/8" dia., two-piece launch rod. Black launch rod safety cap.

SB17850 — \$24.99



Whitewings® Paper Glider Competition Kit

Gr. 4–8 Includes 30 precut gliders (all of the same design), 30 balsa fuselages, 30 sets of 4-page assembly/student instructions, dihedral and camber gauge (precut), and group leader flyer.

SB31179 — \$64.95

ONLY AT NASCO



Nasco Rocketry Classroom Kit

Gr. 5+ Students design and construct their own model rocket while exploring the following topics: design processes, rocket parts, phases of rocket flight, recovery systems, rocket propulsion, rocket engine operation, engine selections, and rocket stability testing. For 25 students. Launch pad not included. ⚠ CHOKING HAZARD (2). Not for under 8 yrs.

◆ SB21470 — \$565.00

Refill for 25 Students

◆ SB21545 — \$329.95

BEST SELLER

ONLY AT NASCO



Nasco Clinometers and Water Rockets Unit: An Integrated STEM Unit

Students experiment and record data using water rockets and clinometers. Each unit includes enough materials for a class of 30 students working in groups of 3, data sheets, and teacher's guide. The unit requires 10–30 calculators, which are not provided. Calculators and extra water rocket launchers may be purchased separately.

TB16224 — \$350.00

TI-30Xa Scientific Calculator

TB22048 — \$14.95

NEW

ONLY AT NASCO

Nasco Film Canister Rocket Classroom Kit

Gr. K–8 In this lesson, students will conduct investigations and build a film canister rocket with water and Alka-Seltzer®. Kit includes lesson plan, reproducible worksheet, 48 Alka-Seltzer tablets, and 30 canisters. Safety glasses recommended.

NE30334 — \$49.95



Bottle Rocket Launcher Kit

Build soda bottle rockets that can soar to heights in excess of 150'. All you need is water. Includes a molded resin launch pad, 2-liter bottle, an altimeter so you can assemble to measure the height of each flight, and an instruction sheet.

SB52970 — \$75.00

Launcher. Includes instruction sheet and an altimeter.

Bottle rocket launch pad sold separately.

SB21429 — \$40.50

Launch Pad. Supports launcher stakes on non-soil surfaces. Molded resin.

SB51811 — \$38.50

2-Liter Bottle

SB53274 — \$1.75

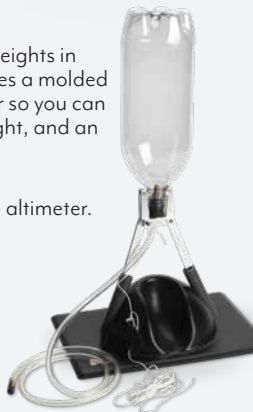

Soda Bottle Rocket Launching Platform

Launch water-powered rockets over 100' in the air. Using water as the liquid fuel, pressurize the bottle with a bicycle pump (Schrader-type connection, bottle not included), then launch remotely via corded release mechanism. Includes bottle rocket launcher attached to sturdy base, stakes, trigger release, vertical launching guide posts, and instructions.

SB52954 — \$77.95



ONLY AT NASCO



Nasco Hot Air Balloon Kit

Gr. 6+ Students build a hot air balloon from a blueprint to learn about how it lifts, stays afloat, and descends. Later, students will plan, build, and test a new design to complete a challenge. For 30 students. ⚠ CHOKING HAZARD (1). Not for under 3 yrs.

SB51903 — \$335.00



Stirling Generator

Gr. 7+ Heat engine shows how thermal expansion and cold shrinkage can create energy. Uses a closed-cycle thermodynamic system in which air is compressed and expanded at different temperatures to create heat energy and power LED lights. **SB51130 — \$109.50**

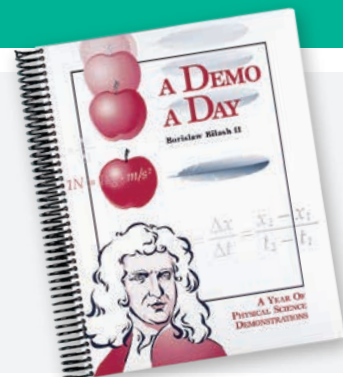

A Demo a Day for Physical Science

Gr. 8+ Nearly 200 demonstrations in physical science, each in an easy-to-follow, concise format. 350 pages. **SB28726 — \$48.95**

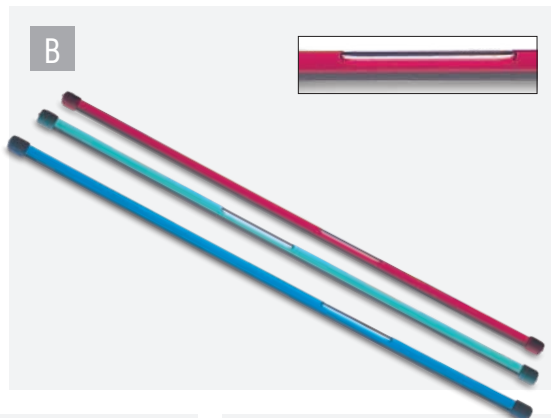
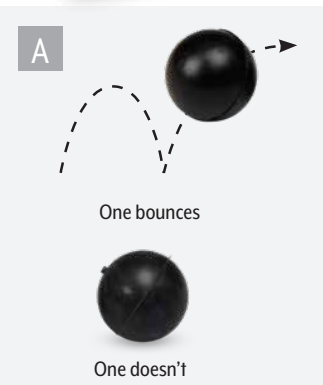

A. Happy/Sad Ball Kit

Two rubber balls that look, feel, and squeeze the same — but try bouncing them. These intriguing inelastic and elastic collision balls are popularly called “happy and sad.” One ball rebounds normally while the other is as bounceless as a piece of clay. Instructions included. **CHOKING HAZARD (3)**. Not for under 3 yrs. **SB33947 — \$9.95**

B. Nasco Speed of a Bubble Tube Test

Gr. 8+ These 3 transparent plastic tubes with colored fluids of 3 viscosities illustrate how a bubble in each tube rises at a constant speed that depends on fluid type, angle of tube inclination, and temperature. Required but not included: metric ruler and clock with sweep second hand. **SB30767 — \$43.95**



C. Nasco Buoyancy Experiment Kit

Gr. 5–8 Explore the factors that cause objects to float or sink. Experiment to investigate how shape and weight affect buoyancy. For 24–30 students. **CHOKING HAZARD (1)**. Not for under 3 yrs. **SB30181 — \$104.95**

D. Seismic Accelerator

Gr. 5+ Watch the law of conservation of energy in action as the red ball skyrockets up to 5 times higher than the height it’s dropped from. **CHOKING HAZARD (4)**. Not for under 3 yrs. **SB51119 — \$14.50**

E. Stirling Engine

Gr. 7+ Runs by exploiting heat flow generated by difference between room temperature and a cup of hot water or ice. Runs at about 150 rpm when used with hot water. Includes activity guide. **SB49166 — \$154.95**



EXPLORE THE LAWS OF PHYSICS
with tools that demonstrate simple machines, energy and motion, and more



Metal Inclined Plane with Pulley and Roller

Gr. 6+ Steel inclined plane (23" x 4") includes graduated protractor and adjustable pulley. 14-oz. roller can be used as a vehicle on a plane or as a counterweight. Also includes pan and cord for masses. **SB43393 — \$105.00**

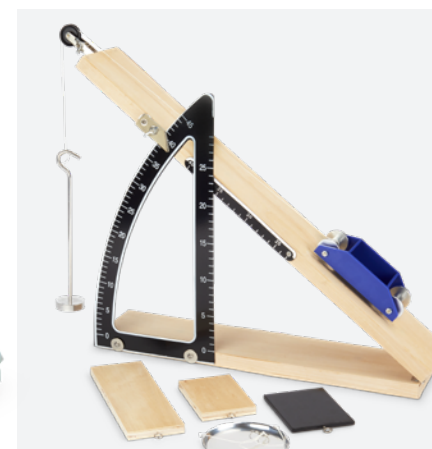

Inclined Plane with Protractor

Inclined plane (can be set at any angle between 0° and 45°) with pulley and protractor, Hall’s carriage, 50 g weight hanger, and activity guide. **SA05707 — \$46.95**



United Scientific Inclined Plane and Lever Kit

Gr. 5+ Explore basic mechanics concepts with this durable, all metal, apparatus. The plane in this kit is wide enough to accommodate standard friction blocks. Adjust the plane’s angle and lock it into place with a single knob, or flatten it for easy storage. Lever features a printed centimeter scale and support holes at the center and ends. Kit includes aluminum plane, aluminum lever, support stand, attachment rod with support clips, and binder clips. **NE30306 — \$55.95**



F. Three-Wheeled Dynamics Carts

One-piece, injection-molded, high-impact, loaded plastic carts. Aluminum piston and piston housing with push-button type starter for explosion of cart. Set of 2. **SB47690 — \$69.95**



G. Deluxe Hall’s Car

Aluminum wheels; axle mounts in cone bearings for low-friction operation; wide, injection-molded plastic body with low profile for bulk loads; open wheels; and deep well for weights. **SB47661 — \$15.80**



H. Mini Dynamics

Gr. 5+ Two scaled-down plastic cars have attached bumpers, deep wells for weights, and low friction wheels that snap into place. **SB26251 — \$19.60**



I. Impact Car

Study the momentum changes of varying mass. Has spring scale and slide that is displaced on impact against obstacle. **SB35037 — \$15.50**



J. Dynamic Cart Kit

Aluminum with minimum friction bearings and center pole that accepts weights. One cart edge is a metal hammer for release of spring-loaded trigger, other edge has clip for holding paper. 2 carts and 4 weights (each 250 g). 6" x 1 3/16" x 3/2". **CHOKING HAZARD (1)**. Not for under 3 yrs. **SB48980 — \$108.00**



L. Bumper Cars Pair Set

Cars conceal high-quality plastic-cased magnets (included). **SB52221 — \$19.95**

Bumper Car Only
SB51116 — \$8.25

Magnetic Floating Ring Set Only. Set of 4. Plastic-cased ring magnets with stand. 1 7/8" x 5/16" thick. **EL12959 — \$12.95**



K. Hall’s Car

Oil-free sleeve bearings, no adjusting. Wide body with low profile for bulk loads. Recession for additional weight. Wheels snap back into place if dropped. Instructions included. **SB31086 — \$12.95**



M. Fan Cart

Demonstrates Newton’s principle of action and reaction. Fan is controlled by a switch. Propeller delivers a thrust of about 88 mN, accelerating the 5 5/8" x 3" x 4 7/8" cart at 0.4 m/s². Attach 4 3/4" x 4 1/8" x 1/16" transparent plate to show the effect of reversing airflow. Includes activity guide. Requires 2 “AA” batteries (not included). **SB48233 — \$22.25**



Student Force Table
Gr. 9+ The classic table for studying a combination of forces. Steel support tube, cast legs, leveling screws, and laminated table top. Comes with 4 all-metal precision pulleys, 2 large and 8 small force rings, cords, 4 weight hangers (50 g), 8 slotted weights (5 g), 4 slotted weights (10 g), 36 slotted weights (20 g), and instructions. 16½" x 16½" x 5¼". Allow extra delivery time.
Z19337 – \$196.50



Thames & Kosmos® SpringBots: 3-in-1 Spring-Powered Machines
Gr. 1+ Learn about potential and kinetic energy and the conversion, storage, and transfer of energy by building a motorized robot, race car, and countdown timer — all powered by a mainspring. 64-page instructions and snap-together assembly.
NE30400 – \$29.95



Bicycle Wheel Gyroscope
 Try to move the rubber wheel's axis of rotation. Suspend wheel from a string with aluminum handle. Hang weights from handle to investigate gyroscopic precession. 20" dia.
SB21409 – \$74.95

BEST SELLER



Nasco Constant Velocity Car
 Holds a uniform speed for conducting kinematic experiments. Car can be set to travel at two different speeds. 6¾" x 3¾" x 2¾". Includes a teacher's guide, batteries, and jumper materials. **CHOKING HAZARD (1)**. Not for under 3 yrs.
SB48981 – \$18.75



Constant Speed Battery Powered Vehicle
 Three-position switch to power in either direction, stable platform, towing hook, and blunt ends for pushing, and spacer.
SB39353 – \$29.95

Newton's First Law



Centripetal Force Kit
Gr. 7+ Uses the weight of 1 g masses from cord end as a counterweight to the pull of a rubber weight swinging in a circle overhead. **CHOKING HAZARD (1)**. Not for under 3 yrs.
SB46995 – \$11.95



Converting Gravitational Potential Energy to Kinetic Energy Kit
Gr. 6+ Quantitatively test how the variables of mass and height affect the energy carried by a metal cylinder. For 24 students. **CHOKING HAZARD (1)**. Not for under 3 yrs.
SB50448 – \$163.00

ONLY AT NASCO

A. Student Projectile Launcher
Gr. 8+ Accurate, safe, and easy-to-use device for demonstrating and studying projectile motion. Use launching cable from behind unit to place shots within a 3" circle at 78¾". Features cocking lever, 3 position settings, one-piece aluminum construction, and instructions. **CHOKING HAZARD (1)**. Not for under 3 yrs.
SB49115 – \$114.95

B. Trebuchet Kit
 Provides hands-on, practical building experience while allowing students to study energy conversion, levers, trajectories, and more. ½" x 4" x 15".
SB40766 – \$16.95
Class Kit. 25 Trebuchet kits.
SB40767 – \$310.00

C. Marble Launcher
Gr. 8+ Launch marbles at 5 speeds. Safety guide printed directly on hardwood marble launcher's surface. Protractor built into launcher. Includes 2 marbles and guide. 16"L x 10"W x 1½"H. **CHOKING HAZARD (6)**. Not for under 3 yrs.
SB48995 – \$94.95

D. Surface Board
 Surface board with 4 surface materials, hooks, wooden blocks, and instructions.
SB10926 – \$32.00

E. Friction Block and Surface Set
 Introduce the concept that friction depends on the nature and smoothness of materials. Includes 3 textured wooden blocks (approximately 3½"L x 2¾"W) with hooks, 1 each of a highly polished block, a sandpaper block, and an aluminum block. 14"L x 2¾"W polished wooden base.
SB40933 – \$15.95

F. Friction Apparatus
Gr. 6+ This 20" x 2" friction board has 4" x 1½" x 1" friction block with hook for spring scale and 2 compartments for additional weights. Place face-up or sideways. Made of smoothly finished pine. 3 weights (50 g) and 100 g spring scale.
SB30030 – \$22.95

BEST SELLER

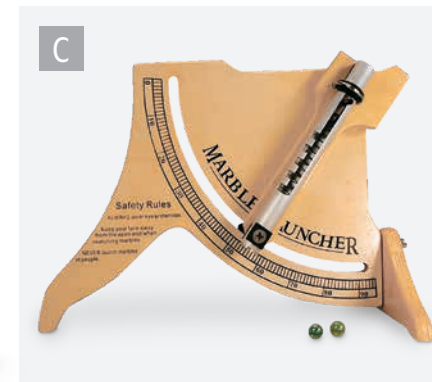
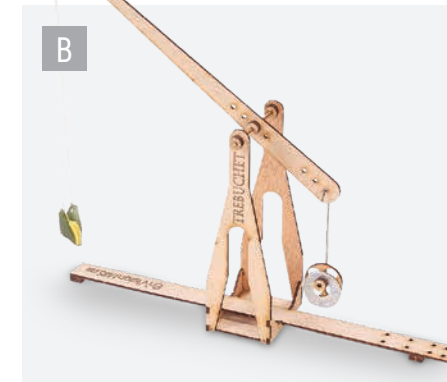
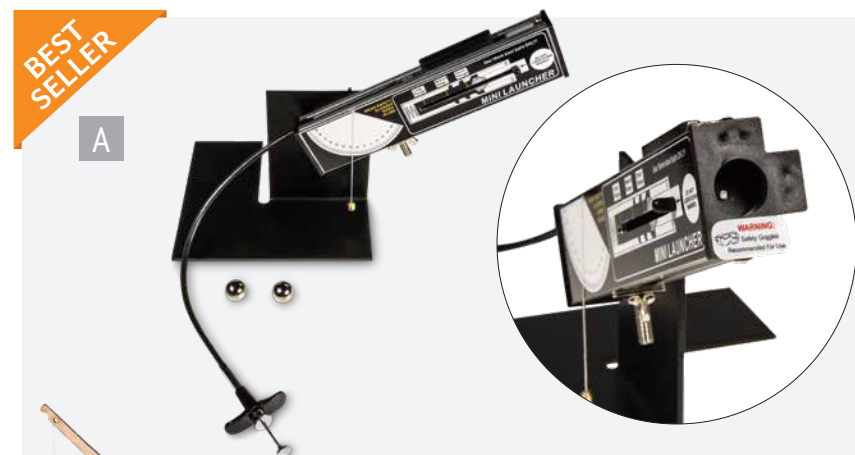

BEST SELLER

Nasco Rubber Band Cannons Unit: An Integrated STEM Unit
Gr. 5-9 Experiment with variables and record data using rubber band cannons. For 30 students. **CHOKING HAZARD (1)**. Not for under 3 yrs.
TB16225 – \$257.00
Rubber Band Cannon Only. **CHOKING HAZARD (1)**. Not for under 3 yrs.
TB16185 – \$19.50



ONLY AT NASCO



EXCLUDED FROM DISCOUNTS

A. Air Track Apparatus
Gr. 6+ Measure uniformly accelerated motion and determine gravitational acceleration. Air is pumped through a hollow track with fine holes all along the track, allowing specially fitted air track cars to glide relatively friction-free. **CHOKING HAZARD (1)**. Not for under 3 yrs. **Z50737 – \$650.00**



B. Pendulum Wave Demo
 Clear acrylic stand with 9 steel ball pendulums (7/8"). Initiator stick helps to release all the pendulums simultaneously. Teacher's guide. **SB51124 – \$114.95**



C. United Scientific Advanced Gen Pendulum Set
 Equip your physics lab with a comprehensive set that includes a simple pendulum, a physical pendulum, and a Wilberforce pendulum. With these compact and precise instruments, your students can explore periodic behavior, oscillation modes, and energy. **NE30450 – \$181.95**



D. Pendulum Clamp
 Clamps securely to any vertical shaft under 1" dia. Clamp has 3 anchor points that allow 3 pendulums to be studied simultaneously. **CHOKING HAZARD (1)**. Not for under 3 yrs. **SB10764 – \$13.50**

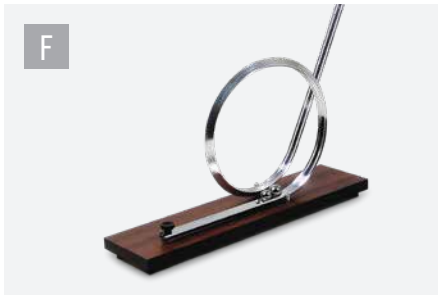

F. Loop-the-Loop Apparatus
 Demonstrates the transformation between kinetic and potential energies when a steel ball runs on the 52" looped aluminum track. 8" dia. loop. 11 1/2" x 4" wood base. Two chrome-plated steel balls. 18" x 14" x 4". **SB40673 – \$29.95**



G. Loop-the-Loop Triple Track
 Set includes 3 tracks — one straight down (28"), one with one loop (54" with 8" dia. loop), and one with two loops (70" with 3 1/2" dia. loop and 8" dia. loop. 15 3/4" x 9 1/2" x 5/8" wooden base. Two steel balls. **CHOKING HAZARD (4)**. Not for under 3 yrs. **SB48324 – \$71.50**

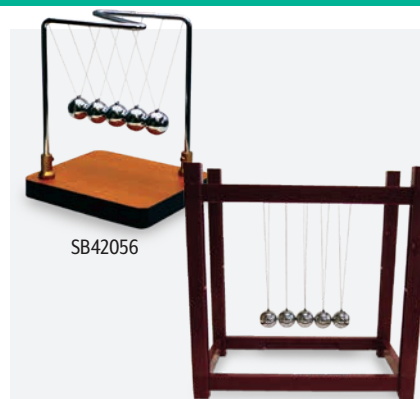

Newtonian Demonstrator
 An excellent device for demonstrating Newton's Third Law of Motion and the principle of Conservation of Momentum. 5" x 4 1/2" x 6". **SB42056 – \$20.95**

Newtonian Demonstrator
 Plastic support with 5 nickel-plated steel balls. 9" x 7" x 8". **SB16568 – \$35.95**



Eisco® Inertia Demonstration Kit
Gr. 8–12 Use this sleek device for demonstrations and experiments with inertia. Features a top receptacle designed to hold an 18 mm ball, a square sheet metal piece, and a precision trigger. Simply pull and release the trigger to slide the sheet out, letting the ball drop into the receptacle with perfect inertia. **NE30617 – \$20.00**



Photogate Timer
 Economical unit with 7 functions: single photogate mode, dual photogate mode, collision mode, acceleration mode, gravity acceleration mode, period (cycle) mode, and count mode. Functions store up to 20 data points in memory. Measures time to 0.0001 seconds. Two photogates, magnetic ball release, and instructions. Runs on AC adapter or rechargeable batteries (not included). **CHOKING HAZARD (1)**. Not for under 3 yrs. **SB47664 – \$245.95**



BeeSpi V Speed Measuring Tool
 Unit detects an object passing through two points about 40 mm apart via built-in photo sensors and indicates the object's velocity in digital form. Infrared sensors inside detect the time when the object passes each spot, indicating object's velocity. Measures speed and cumulative lap time. Measures in km/h, m/s, and cm/s. **SB47275 – \$91.00**



Digital Velocity Speed Gun
 Accurately measures speeds of objects in motion. Just point and shoot. Large LCD screen. Speeds +/- 1.0 mph; measure a baseball at 90'; measure a vehicle up to 1,300'. **SB44701 – \$215.00**



Spark Timer
 Paper tape is pulled through the timer while a spark at a very precise interval is created which burns tiny dots in the paper strip as it passes. Distance between the dots determines how fast object is falling or moving. **SB42032 – \$30.75**

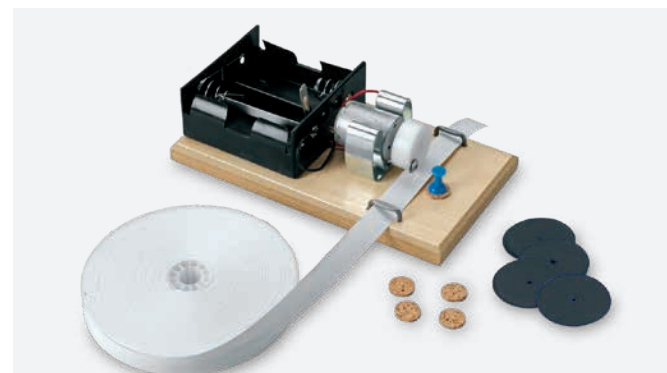

Acceleration Timer (DC)
 Clamp to bench top or ring stand for recording objects of varying speeds. Assembled motorized striker, carbon discs, ticker tape, and instructions. **SB19009 – \$44.95**

Keep exploring at
nascoeducation.com



Forces and Simple Machines Kit

Gr. 6+ Contains a variety of custom-made and unique components, including Force Board, Inclined Plane, and Vector Board. Also included is a complete set of accessories needed for 15 activities, lab activities manual, and CD with slide presentation of all the experiments.

SB43478 – \$255.00

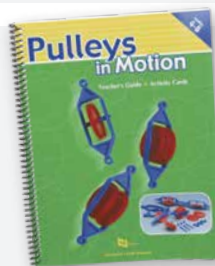

Pulleys in Motion Class Set

Gr. 4+ Teach the mechanical principles of pulleys to a whole class. 32-page guide provides easy-to-understand hands-on activities. Includes necessary components. **CHOKING HAZARD (I).** Not for under 3 yrs.

SB36700 – \$84.95



For vacuum pumps, see p. 141



Free Fall Tube

Demonstrate that lighter objects experience the same acceleration as heavier objects by evacuating air from the tube. Plastic tube is closed at each end by a vacuum-tight cap. Bottom cap is fitted with a stopcock for air evacuation.

SB23861 – \$60.95



Collision Ball Apparatus

Gr. 5–8 Demonstrates momentum, conservation of energy, rolling and sliding friction, Newton's Third Law of Motion, and the effects of acceleration and gravity on a moving body. Use on a table, or raise an end to create an incline. Aluminum V-shape track (27"L) and 5 steel balls (3/4" dia.).

Includes instructions. **CHOKING HAZARD (I).** Not for under 3 yrs.

SB48979 – \$22.95

Demonstration Balance Kit

Gr. 7+ Provides support for meterstick demonstration balances and torque experiments. Includes 1 of each item below.

SB51311 – \$20.50

Lever Knife-Edge Clamp. Use metal clamp to make a balance out of a meterstick. Wire stirrup can be used for suspension of weights.

SB13912 – \$2.95

Demonstration Balance Support. Cast metal. 7 1/4". Requires knife-edge clamps, slotted weights and hangers, and meterstick.

SB51310 – \$17.95

Senior Meter Stick. Front is calibrated in 0.5 cm and numbered each cm. Reverse side is calibrated in mm.

SB52796 – \$3.95



Second Law of Motion Apparatus

Propels one ball horizontally while releasing another simultaneously to fall vertically. Cock spring at two different tensions. 15 cm long platform has attached 1 cm dia. rod to permit support at any desired height.

SB10376 – \$27.95



Collision in Two Dimensions

Curved aluminum track and adjustable target support form unit's core. Includes two steel balls, glass ball, hollow wooden ball, plumb bob, and activity guide. 20" x 13" x 10".

SB16605 – \$21.95

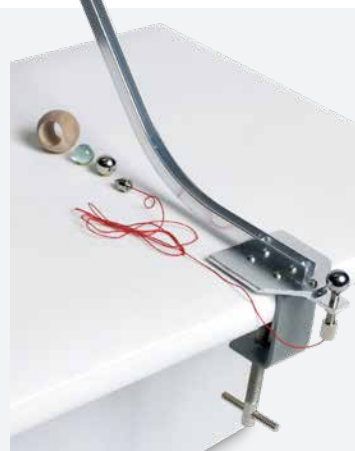

Esco Advanced Pulley Demonstration Set

Gr. 6+ Demonstrate concepts associated with pulleys and their configurations. Can demonstrate multiple configurations simultaneously. Metal base, steel rods, 8 single pulleys, 2 triple-tandem pulleys, 2 quadruple pulleys, 1 heavy composite base (32" x 7 7/8") with 2 sockets, capstan and eye hook, 3 rods (32"), 8 collars with hooks, 3 right-angled clamps, wheel and axle, 4 rolls of cord, and Tommy bar to tighten vertical rod.

SB51183 – \$555.00

Student Pulley Demonstration Set. Gr. 6+

Includes 8 single pulleys, 2 double-sheave ball bearing frictionless pulleys, 7 7/8" x 5 7/8" wooden base with 24" vertical rod and 7 7/8" horizontal rod with clamp, 6 collars with hooks, right-angled clamp, wheel and axle, 2 rolls of cord, Tommy bar to tighten vertical rod, 9 hooked brass weights (10 g, two 20 g, 50 g, 100 g, two 200 g, 500 g, and 1,000 g), and instructions.

SB51184 – \$295.00

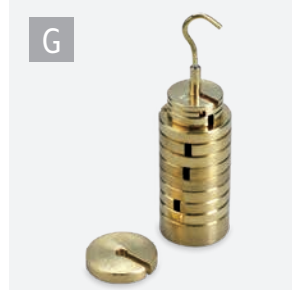
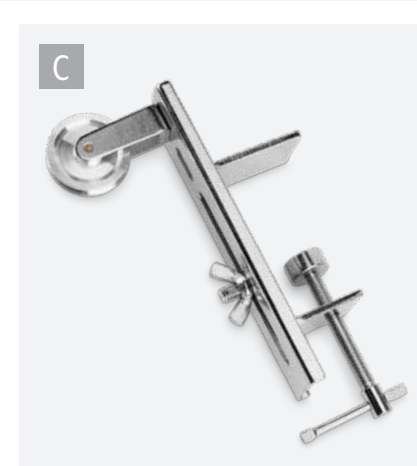
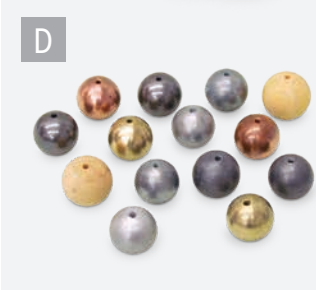

A. Hooke's Law Apparatus

Heavy base with adjustable mirror millimeter scale, spiral spring with indicator and weight hanger, and four 20 g slotted weights.

SB16580 – \$35.95

B. Tabletop Pulley

Adjusts over a height range of 10 cm, locks in place with a thumbscrew, and rotates 360°. Two-piece apparatus consists of glass-filled, nylon-molded clamp and pulley with sheave attached to rod. Clamp fits tables up to 5 cm thick. Rod is 15 cm x 6.4 mm dia. Coefficient of friction: 0.04.

SB37209 – \$28.95

C. Adjustable Bench-Mounting Pulley

All-metal construction. Height can be adjusted vertically and tightened at any point from parallel with clamping surface up to 2" above it. Mount on surface up to 2" thick. 1 1/8" dia. aluminum pulley.

SB48967 – \$6.70

D. Drilled Ball Set

Two balls each of aluminum, brass, copper, iron, lead, zinc, and wood. 1" each. **CHOKING HAZARD (I).** Not for under 3 yrs.

SB49320 – \$57.95

E. Pulley Cord – 30' Roll

Tightly braided nylon.

SB15378 – \$6.25

F. Slotted Weight Set

Steel set includes 100 g hanger and nine 100 g slotted weights. Total weight: 1,000 g. **CHOKING HAZARD (I).** Not for under 3 yrs.

SB46832 – \$39.95

G. Copper Slotted Weight Set with Hanger

Nickel-plated copper slotted weights with hanger. Two 5 g, one 10 g, and nine 20 g weights with a 50 g hanger. Total weight: 250 g. Plastic storage case.

SB26385 – \$17.95

BEST SELLER



SBI6725

ONLY AT NASCO

Nasco Forces, Motion, and Simple Machines Kits

Gr. 4–8 Investigations include force couples involving “action and reactions,” sliding and rolling friction, centrifugal and centripetal forces, velocity, simple periodic motion, periodic motion of a pendulum, uniform linear motion, accelerated motion, efficiency of machines, ideal and actual mechanical advantage, pulley systems, the pulley as a modified lever, the inclined plane, and the use of levers to multiply force and speed and change direction. Aligned with NGSS. Teacher’s guide.

Forces, Motion, and Simple Machines Multi-Group Kit. For 6 work stations. **CHOKING HAZARD (I).** Not for under 3 yrs. **SB16725 – \$675.00**

Forces, Motion, and Simple Machines Demonstration Kit. For 1 work station or a classroom demonstration. **CHOKING HAZARD (I).** Not for under 3 yrs. **SB50706 – \$165.00**



SB51743

ONLY AT NASCO

Nasco Forces Kits

Gr. 5–8 Investigations include force couples involving “action and reactions,” sliding and rolling friction, and centrifugal and centripetal forces. Aligned with NGSS. Teacher’s guide. **CHOKING HAZARD (I).** Not for under 3 yrs.

Forces Multi-Group Kit. For 6 work stations. **CHOKING HAZARD (I).** Not for under 3 yrs. **SB51743 – \$435.00**

Forces Demonstration Kit. For 1 work station or a classroom demonstration. **SB51741 – \$105.00**



NewPath Learning® Physical Science Workbook Set with Digital Access

Gr. 6–10 Colorfully illustrated workbook set for use in the classroom or at home. In-depth, interactive lessons are based on NGSS concepts.

Each printed workbook contains 36+ pages of self-directed readings, illustrated explanations, guiding questions, a lab investigation, key vocabulary review, and assessments.

The one-year, corresponding digital access includes animated and narrated tutorials, interactive exercises and activities, virtual labs, online glossary, visual resource library, and an inquiry based student activity guide. Even works with classroom presentations on whiteboard.

Set includes 10 workbooks:

- Properties & States of Matter
- Atoms & Chemical Bonding
- Elements & the Periodic Table
- Chemical Reactions
- Energy: Forms & Changes
- Forces & Motion
- Work, Power & Simple Machines
- All About Sound
- Light & Optics
- Electricity & Magnetism

NE30054 – \$129.95



SB50709

ONLY AT NASCO

Nasco Simple Machines Kits

Gr. 4–8 Investigate the use of levers to multiply force and speed and change direction, the pulley as a modified lever, the inclined plane, ideal and actual mechanical advantage, and the efficiency of machines. Aligned with NGSS. Teacher’s guide.

Simple Machines Multi-Group Kit. For 6 work stations. **CHOKING HAZARD (I).** Not for under 3 yrs. **SB50709 – \$380.00**

Simple Machines Demonstration Kit. For 1 work station or a classroom demonstration. **CHOKING HAZARD (I).** Not for under 3 yrs. **SB19237 – \$87.00**

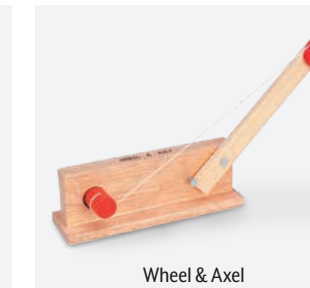
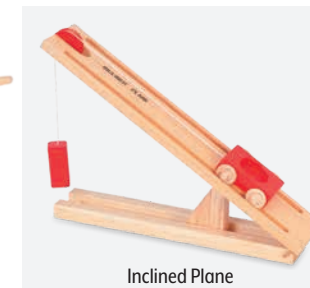

Pulley

Wooden Simple Machines Complete Student Set

Each model measures 6”–8” and includes a detailed activity guide which details the history of the model, practical applications, and classroom experiments. Includes 1 each of all 8 simple machines below. **CHOKING HAZARD (I).** Not for under 3 yrs. **SB40569 – \$290.00**

Wooden Simple Machines Set 1

Includes 1 each of Lever, Pulley, Inclined Plane, and Block and Tackle. **SB40567 – \$144.00**

Wooden Simple Machines Set 2

Includes 1 of each of Wheel and Axle, Gear Train, Pendulum, and Screw. **CHOKING HAZARD (I).** Not for under 3 yrs. **SB40568 – \$163.00**

Thames & Kosmos Forces & Interactions: Middle School Physics Classroom Kit

Gr. 6–8 Bring the fun of hands-on physics to your middle school classroom with comprehensive lesson planning resources and durable building materials. 116-page teacher guide includes lesson plans, objectives, and assembly instructions for 10 NGSS-aligned activities. Includes materials for up to 4 students. Includes 437 pieces, which come in a stackable plastic storage bin with sorting tray and building lid. Requires 2 “AA” batteries. **CHOKING HAZARD (I).** Not for under 3 yrs. **NE30279 – \$179.95**



Thames & Kosmos® Newton’s Apple Tightrope-Walking Gyrobot

Gr. 3+ Explore gravity, motion, Newton’s laws, force, speed, rotation, balance, and weight by building a robotic apple that defies gravity and walks a tightrope. Includes a 12-page guide with 5 experiments. **NE30397 – \$29.95**



BEST SELLER

Easy-to-use kits are ideal for studying Newton's Laws of Motion. The flexibility and durability of the track allow for simple or complex races that can include loops, curves, hills, ramps, and jumps. Can test a variety of objects.

BluTrack® Adapted Learning Kit

Includes 18' BluTrack®, 4 ramps, 2 racer cars, and adaptive tape for easy experiment setup. Comes with tape pre-attached to track and ramps. Online teacher's guide gives instruction in setting up lab and lesson.
SB51254 – \$126.65

BluTrack® Intro to Force and Motion Kit

Gr. PreK+ Specifically designed for elementary classrooms, this economical kit features two 6' tracks. Kit also includes 4 ramps, structure inserts to aid in setup, 2 variable mass physics cars, 2 racer cars, 2 graduated bottles, and a measuring spoon.
EL15016 – \$170.00

BluTrack® Advanced Force and Motion Kit

Gr. K–8 Includes 2 full Intro to Force and Motion Kits, two 18' EP Tracks with hanger system and anchor bar, and 8 additional ramps.
SB52309 – \$595.00

Engineering Coasters and Motion Kit

Gr. 6+ Combines the physics of motion with the basics of engineering coaster designs. Includes 12 anchor bars, four 18' tracks, 16 ramps, 4 PVC insert kits, teacher's guide, student's guide, and complete experiment guide.
SB52310 – \$510.00



Aligned to NGSS

SB52309



Wind Power

Gr. 3+ Assemble a wind turbine complete with an electric generator and adjustable rotor blades. Then conduct experiments to optimize the turbine's performance and discover how the turbine can light up an LED and recharge a battery. Includes manual.
SB47040 – \$62.95



Gravity-defying fun!



A

A. BluTrack® Junkyard Challenge Kit

Gr. 7+ Whether used on its own or in conjunction with a larger junkyard engineering challenge, this kit is all about exploring the design possibilities. Includes a 50' track with hanger pad, a 50' support aluminum wire, 3 PVC support insert kits, 12 anchor bars, and 10 ramps. Cars sold separately.
SB52311 – \$340.00



Physics Cars. Die-cast cars. Includes 8 cars and 50 washers. Each car measures 2½" x 1¼" x 1⅞".
SB51255 – \$63.75



BluTrack® Track. Includes an 18' track with hanger system and anchor bar.
SB52312 – \$63.75

Hydro-Wind Education Kit

Gr. 5+ Generate hydrogen from wind power. Use angular velocity, drag force, and other physics concepts to design and build a wind turbine. LED Voltmeter/Music Maker Module demonstrates power created from wind energy. Curriculum on wind energy and fuel cells.
 ⚠️ CHOKING HAZARD (1). Not for under 3 yrs.
SB46794 – \$301.00



Horizon Renewable Energy Education Set

Unit on clean power generation includes an exploration of the environmental effects of atmospheric carbon dioxide. Hands-on activities center on complementary attributes of renewable energy sources. Up to 10 class periods of activities. For 3–4 students.
 ⚠️ CHOKING HAZARD (1). Not for under 3 yrs.
SB46790 – \$405.00



Radiometer

Partially evacuated glass bulb contains spinner with 4 vanes, blackened on one side, silvered on the other. Turns 3,000 revolutions a minute in sunlight. Will also turn under an incandescent lamp (100 watts or more).
S00154 – \$15.95

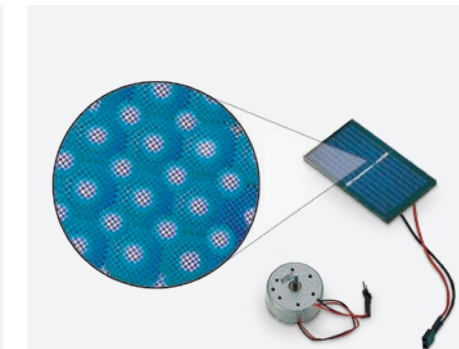

Solar Science Kit

Gr. 5+ PV cell, high-efficiency motor, disc with diffraction foil, and informative solar sheet with ideas for science projects.
SB27511 – \$14.95



PowerWheel Kit

Gr. 5+ Hook micro hydro generator up to a faucet or a hose, then watch it take energy from flowing water and convert it into mechanical energy, then into electricity. Includes PowerWheel, LED light strip, bridge rectifier, all the wiring to convert the AC output to DC for powering battery-powered devices, and user's manual.
SB49096 – \$189.95

BEST SELLER

Solar Bottle Boat Kit
Gr. 5+ Build 3 solar-powered boats using “recycled” bottles. **⚠ CHOKING HAZARD (I).** Not for under 3 yrs.
SB40881 – \$33.99

BEST SELLER

ONLY AT NASCO

Nasco Solar Bottle Boat Class Kit
Gr. 5–12 Everything you need for 6 students or 6 groups, including 6 Solar Bottle Boat Kits (SB40881, above), plastic bottles, paints, and more. **⚠ CHOKING HAZARD (I).** Not for under 3 yrs.
SB53392 – \$300.00

Solar-Powered Car
Gr. 3+ Operates on sunlight, battery, or strong lamp. 4¾" x 2¾" x 3". Requires 1 “AA” battery, not included.
SB47681 – \$25.50

BEST SELLER

Horizon Fuel Cell Car Science Kit
Gr. 5+ Investigate reaction yields, reduction and oxidation, and other chemistry concepts by performing electrolysis reactions. Learn about conservation of energy, electric power, and other physics concepts by modifying your fuel cell car. **⚠ CHOKING HAZARD (I).** Not for under 3 yrs.
SB46787 – \$135.00

Photon Solar Racer Kit®
Gr. 4–9 Travels an average of 10 ft. in 3 seconds on smooth, flat surface when exposed to full sunlight. 9" x 2". **⚠ CHOKING HAZARD (I).** Not for under 3 yrs.
SB23862 – \$33.99

EXCLUDED FROM DISCOUNTS

Regatta® Inflatable Raceway
 Place two 6' tables end-to-end, inflate heavy-duty vinyl raceway, and fill each lane with approximately 4 gallons of water.
NA10268 – \$32.95

Solar Tube
 Fill with air by running, tie off ends, and let the sun heat air inside tube. In about 5 minutes, tube (which must be tethered with string) will rise into sky. 50' x 29" dia. plastic tube holds over 200 cu. ft. of air.
SB33233 – \$21.96

Solar Balloon Energy Kit
Gr. 5+ Explore the properties of light, define optical design, demonstrate energy conversion, generate thermal energy, understand renewable energy, and teach sustainability, all while delivering a high-quality STEM experience.
SB52005 – \$69.95

A

A. Tin Can Robot
Gr. 5+ Turn a metal soda can into a walking, wobbling, bug-eyed robot, then transform it into a robotic monster. Teaches about recycling and green technology. Requires 2 “AAA” batteries, not included. **⚠ CHOKING HAZARD (I).** Not for under 3 yrs.
SB47082 – \$19.95

B

B. Solar Experimenter's Kit
 Build your own solar demonstrator. Encapsulated solar cell module, DC motor, holographic disc, and an informative solar energy booklet with charts and graphs explaining photovoltaic solar energy. **⚠ CHOKING HAZARD (I).** Not for under 3 yrs.
SB07000 – \$17.50

C. Radiation Kit
 Use for experiments dealing with heat absorption of light surfaces vs. dark surfaces. 16-oz. black metal container, 16-oz. shiny metal container, 2 insulating lids, 2 thermometers (-20° to 50° C), 110V AC clamp lamp with reflector, and 150-watt light bulb.
◆ SB02019 – \$64.95

Mini Panels Encapsulated Solar Cells
 Uses safe solar cells similar to those that power satellites in space. Mini panels allow for handling with less breaking and cell damage. 6" wires. 3¾" x 2½".

6.0V Solar Cell. 50mA. Charge batteries, light LED bulbs, and run small radios. Does not run motors.
SB16287 – \$25.00

3.0V Solar Cell. 100mA.
SB16288 – \$21.75

1.5V Solar Cell. 200mA.
SB16289 – \$18.00

1V Solar Cell. Best for motors. 400mA.
SB46194 – \$15.00

Solar Kit Mini Motor – 1.5V
 Low-cost motor for experiments using low starting voltage (½V). 2 mm shaft dia. 4" lead wires. 1" dia. x 1½" L.
SB53049 – \$4.95

Solar Kit Motor – 1.5V to 3V
 Operates ½V-3V and 200 mA start-up/runs at 80 mA to load. Low torque; high rpm. 2 mm shaft dia. 1" dia. x 1½" with 6" lead wires. **⚠ CHOKING HAZARD (I).** Not for under 3 yrs.
SB33479 – \$6.50

C

D

D. Energy Beads
 Uncover the hidden energy of ultraviolet light as beads change from white to a rainbow of colors when in the sun. **⚠ CHOKING HAZARD (I).** Not for under 3 yrs.
SB47413 100 beads – \$3.95
SB51138 250 beads – \$7.00
SB48486 1,000 beads – \$25.00

Scan for more alternative energy favorites at nascoeducation.com



Solar-Powered Rovers

Gr. 3+ Harness the power of the sun by building five motorized models: three solar cars, a solar fan, and a solar robot. Perform experiments with each model to learn about gear ratios, solar cells, and more. Includes 54 pieces and 16-page illustrated manual. **NE30117 – \$19.95**

Build unique robots that are powered by the sun



8-in-1 SolarBots

Gr. 1+ Using a compact solar panel, these bots harness energy from the sun to power an electric motor. Build a drummer that marches along, beating a drum; an armadillo robot that does somersaults; a bug that crawls on six legs; and more. Includes 194 pieces and 48-page guide. **NE30118 – \$24.95**



HOW DOES WATER TURN INTO ENERGY?

Let's experiment and find out!



Hydropower

Gr. 3+ Building projects and 12 experiments show how different devices are used to extract useful energy from moving water. Harness mechanical energy from water to do physical work, make a hydroelectric power station to generate electricity to light an LED, and more. **EL11475 – \$49.95**

BEST SELLER

A



A. Energy Conversion Kit

Gr. 7–12 Demonstrate the conversion between different forms of energy. Includes 4 devices for generating electrical energy and 3 devices that use electrical energy. Included set of cables connects devices to each other in various combinations.

SB53165 – \$78.95

B. Biofuels: Investigating Ethanol Production and Combustion Lab

Gr. 6+ The 3 investigations include: a demonstration of corn and cane sugar and the fermented stillage to produce fuel, investigating the energy released by combustion of ethanol and kerosene and comparing the results, and measuring and comparing 2 fuel by-products. For 6 groups of 4 or 5. **CHOKING HAZARD (I)**. Not for under 3 yrs.

◆ C29169 – \$276.30

B



C. Individual Student Solar Energy Science Kit

Gr. 6–12 Introduce students to how solar light energy is converted into electrical energy. A photoelectric panel collects sunshine, while 3 "consumers" are included to demonstrate use/users of the electrical energy (an LED for light energy, a buzzer for sound energy, and a motor for mechanical energy). A mirror allows students to test varying the amount of sunlight collected by the panel to see if more/less light produces more/less electrical energy. Instructions included.

NE30023 – \$11.50

E

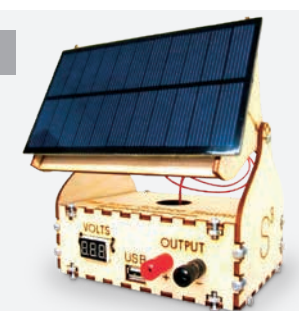

D. Solar Kit

Gr. 5–9 Demonstrate the effect of solar power and its ability to be converted to mechanical energy, light energy, battery power, and current. 3½" x 3½" mounted solar cell (with terminals, motor, LED, and mounted battery and ammeter on 8" x 4¾" base).

SB43494 – \$35.25

E. Solar Science Station

Gr. 5+ Three uses: solar USB charger, power supply for other gadgets, and tool for recording solar data. Designed around a large 5.5V 320mA solar cell on rotating axis for adjusting solar cell's angle. Station front contains several ports, including LED voltmeter, USB port, and 2 simple terminal screws for direct power out. All wires are connected to a central screw terminal hub. Requires screwdriver and wire stripper. No soldering required.

SB50641 – \$49.95



Thames & Kosmos WindBots: 6-in-1 Wind-Powered Machine Kit

Gr. 3–11 Harness the wind to power 6 awesome bots that move without any batteries or electricity. As students build and experiment, they'll learn about how gears transmit power, torque and wind as a power-generating technology. Includes 133 pieces and a 52-page guide. No batteries or electricity required. **CHOKING HAZARD (I)**. Not for under 3 yrs.

NE30276 – \$32.95



Thames & Kosmos Water Power: Rocket-Propelled Cars, Boats, and More

Gr. 3–9 Make a splash into physics with 6 air-and-water-powered models. As students build and experiment, they'll learn about the physics of action-reaction forces, rocket propulsion, nature's rockets, compressed air, and pneumatics. Includes 47 pieces and a 32-page guide. No batteries or electricity required. **CHOKING HAZARD (I)**. Not for under 3 yrs.

NE30277 – \$29.95

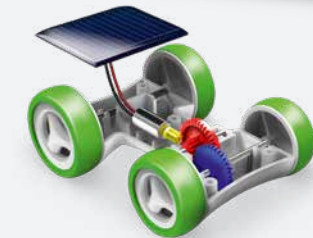

Thames & Kosmos® Solar Race Car

Gr. 3+ Convert solar energy from the sun to power a solar race car. Full-color, step-by-step instructions for 22 snap-together pieces, including gear train and adjustable solar panel.

NE30396 – \$15.95



AirZooka™
Teach the science of an air vortex. Pull back and release built-in plastic air launcher to shoot a harmless ball of air up to 20'. Assorted colors.
SB40514 – \$24.95

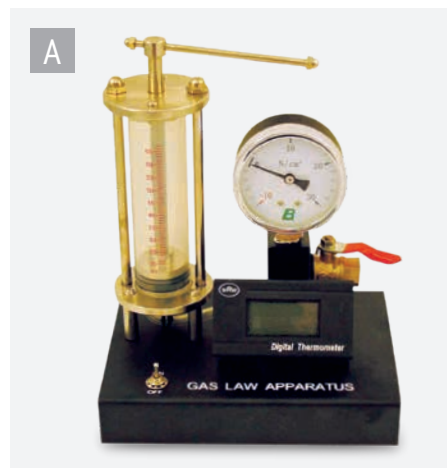

A



B



C



D

Boom!



E

Add boiling water to watch the can get crushed!

A. Gas Law Apparatus with Temperature Gauge
Gr. 9+ Twist handles to compress air and read volume, temperature, and pressure from scales. Repeat to confirm relationship stays the same. Requires 1 "AA" battery, not included.
SB45488 – \$102.95

B. Boyle's Law Apparatus
Investigate elastic properties of gas enclosed in a calibrated airtight syringe by subjecting confined gas to various loads. Syringe built into wood base. Wooden top supports arbitrary uniform weights. Includes activity guide. 9" x 6" x 2".
SB16604 – \$17.75

C. Innovating Science® The Ideal Gas Law Kit
Students perform the reaction between sodium bicarbonate and hydrochloric acid, use the ideal gas law to calculate the amount of carbon dioxide produced, and then use stoichiometry to determine the percent yield. Includes materials for 15 groups of students, teacher's manual, and student guide. **CHOKING HAZARD (2)**. Not for under 3 yrs.
◆ NE30205 – \$51.95

D. Fire Syringe
Gr. 6+ As air compresses, the temperature increases and combustible material bursts into flames.
SB42045 – \$20.95

E. "Charles' Law Mechanics of Gas" Can with Lid
Boil water in the can and allow to cool. See the can get "crushed" right before your eyes. Metal can with lid, 1 1/4" opening.
SB28561 – \$21.95

BEST SELLER

Experiment with density with brass, acrylic, pine, and more!

Density Cube Sets
Gr. 5+ Cubes for experimenting with mass, volume, density, buoyancy, specific gravity, and flotation. 1-1/4".
4-Cube Set. Nylon, acrylic, aluminum, and pine wood.
SB44474 – \$15.95
10-Cube Set. Aluminum, steel, brass, copper, acrylic, maple, nylon, pine, poplar, and PVC.
SB31356 – \$40.95
12-Cube Set. Copper, brass, steel, aluminum, acrylic, oak, nylon, pine, poplar, PVC, lignum vitae, and polypropylene.
SB45884 – \$46.50



Equal Mass Cylinder Density Set
Demonstrate the inverse relationship between density and length. Includes 5 cylinders weighing 15 g each: copper, aluminum, nylon, polyvinyl chloride, and polyethylene. All are 1/2" (12 mm) dia. and range from 5/8" to 4" (15-100 mm) in length.
SB15356 – \$13.50



Density Cube Set
1/2", 1", and 1 1/2" cubes of 8 materials: acrylic, aluminum, brass, copper, nylon, polypropylene, PVC, and steel. Reference table shows density values of specimens.
SB53047 – \$154.95



Density Identification Set
Identify 12 samples of common materials by determining their density. Each 1/2" dia. cylinder varies in size and density. Lengths vary between 1 9/16" and 2 5/8".
SB39210 – \$45.95



Set of 18 Density Blocks
Includes 10 mm cube, 20 mm cube, and 30 mm x 20 mm x 10 mm block each of aluminum, brass, copper, lead, steel, and zinc. **CHOKING HAZARD (1)**. Not for under 3 yrs.
SB45749 – \$50.95

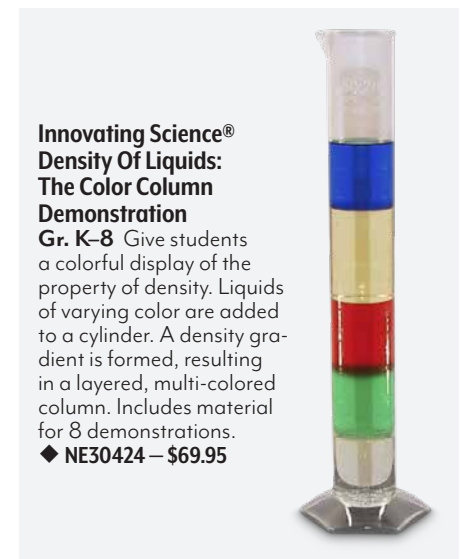

Innovating Science® Density Of Liquids: The Color Column Demonstration
Gr. K-8 Give students a colorful display of the property of density. Liquids of varying color are added to a cylinder. A density gradient is formed, resulting in a layered, multi-colored column. Includes material for 8 demonstrations.
◆ NE30424 – \$69.95



HOW DOES TEMPERATURE AFFECT DENSITY?
Find out by experimenting with these tools



A. United Scientific Digital Infrared Thermometer
Temperature range: -50°C to 500°C (-58°F to 932°F). Field of view: Approximately 12:1 distance-to-spot ratio (90% encircled energy at focal point). Diode laser: Output <1 mW. Automatic shut off after 7 seconds. Uses 2 AAA batteries (included). 6" x 1" x 2.2".
NE30535 – \$47.50

B. Conductivity Bars
Gr. 6+ Steel, brass, aluminum, and copper specimens enclosed in plastic housing. Liquid crystal thermometer on each strip.
SB46988 – \$44.95

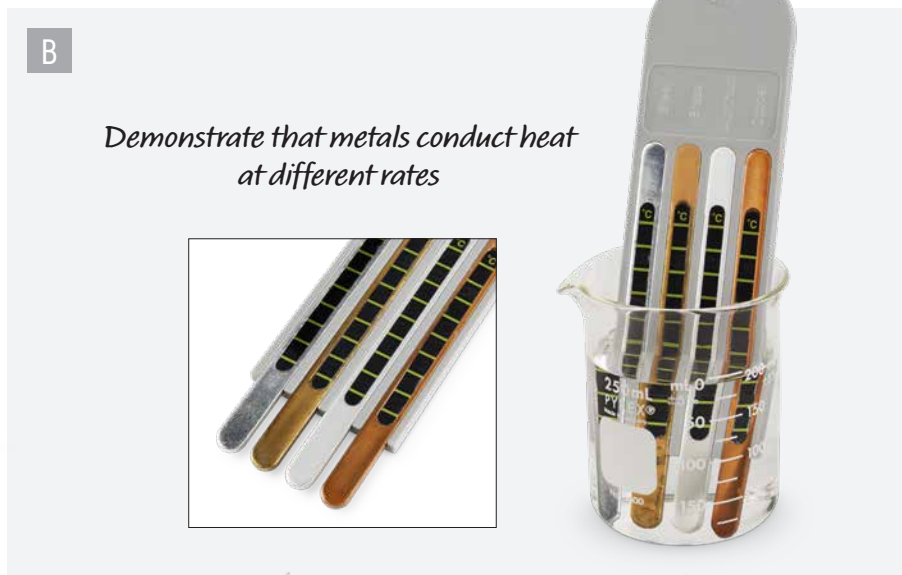

C. Hand Boiler
Watch as liquid rises and bubbles from heat of your hand. Color and style may vary. 7".
◆ SB50603 – \$6.95

D. Heat Pack
Snap metal disc to create a chain reaction, causing solution of water and sodium acetate to crystallize and give off heat. 4" x 4".
SB47058 – \$6.50



E. Clear Acrylic Overflow Can
Gr. 7+ Graduated up to 125 ml. Attached spout.
SB52154 – \$8.25

F. Overflow Can
Determine the volume of a body to calculate density, specific gravity, or for proving Archimedes' Principle. 3" dia. with flared top edge and angled spout. Aluminum.
SB16803 – \$9.75



G. Pulse Glass
Hold one glass bulb in hand to cause evaporation of a portion of the liquid, which forces liquid into other bulb. CAUTION: Only operate using hand heat.
◆ SA09087 – \$11.00

H. Ball and Ring
3/4" dia. brass ball fits into brass ring. Heat ball to prevent passage through ring until cool or unless ring is heated.
SB07985 – \$13.95

I. Ice Melting Set
Place an ice cube on each of the 2 black blocks (1 aluminum, 1 plastic foam) and watch as 1 ice cube melts faster.
SB39159 – \$26.95

TURN UP THE HEAT
Conduct experiments in the lab using tools that can withstand high temperatures

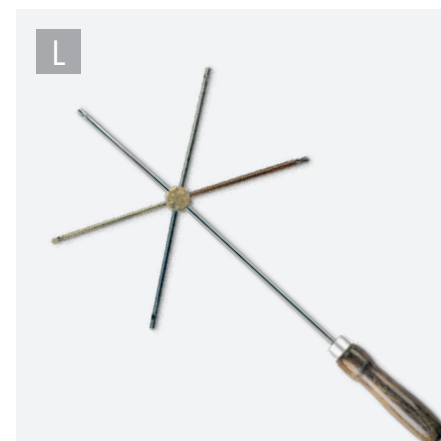

J. Convection Apparatus
Metal box with glass front and 2 mounted acrylic chimneys. Place candle under one chimney and smoke-producing material at mouth of other chimney to create convection currents.
S00185 – \$33.95

K. Heat Transfer Kit
Observe heat transfer by measuring temperatures of insulated containers before and after connecting them with metal bar.
SB52555 – \$27.50

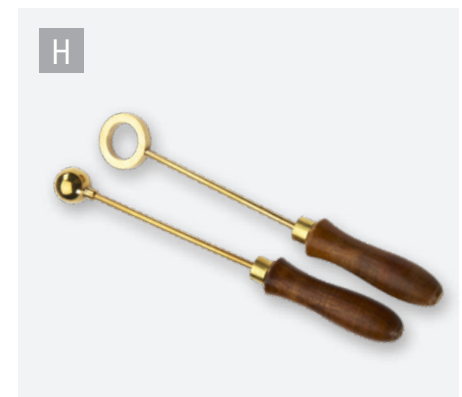

L. Conductometer
Demonstrates the conductivity of silver nickel, steel, aluminum, copper, and brass. Mounted on plated steel rod with wooden handle.
S00187 – \$17.95

M. Double-Walled Calorimeter with Electric Option
Use with or without electricity. Double-walled cover minimizes heat loss. Aluminum inner and outer vessels. Stirrer and support for inner vessel (capacity: 300 ml).
SB13895 – \$14.95

Unmounted Plane Mirrors

Flat, silvered acrylic, square mirrors measure 10 cm. Dimensions may vary. Pkg. of 12. **SB16721 – \$23.25**

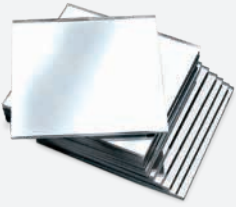

Acrylic Mirrors

Highly reflective, rigid acrylic mirrors. 4 3/4" x 3 3/4" x 1/8". Pkg. of 10. **SB26049 – \$23.00**



Double-Sided Mirrors

Flexible, plastic, concave/convex mirrors cut easily with scissors. 4" x 4". Pkg. of 10. **SB28627 – \$11.50**



Acrylic Prisms

Highly polished acrylic equilateral prisms. Includes one each of 25 mm, 50 mm, and 100 mm prisms, all with 25 mm sides. Set of 3. **SB28596 – \$16.95**



Spherical Mirrors

Glass spherical mirrors with back surface silvering. Includes 3 convex and 3 concave mirrors, each measuring 50 mm dia. and with a different focal length. Set of 6. **SB47752 – \$17.50**



Mirror Clips

PVC plastic. Pairs hold long rectangular mirrors. Pkg. of 36. **SB28855 – \$12.50**



Equilateral Prism

60° glass prism with 30 mm base and faces.

1" (25 mm) x 2" (50 mm) **SBI4088 – \$6.50**

1" (25 mm) x 3" (75 mm) **SBI4089 – \$7.50**

1" (25 mm) x 4" (100 mm) **SBI4090 – \$8.50**

Acrylic Prisms

Polished to perfection. Projects a superior spectrum to glass. No sharp edges if accidentally chipped.

Product No.	Description	Each
SBI8047	2" Right Angle	\$7.95
SBI8048	2 1/2" Equilateral	\$11.00

Acrylic Prisms

Clear acrylic sheet. All sides polished. Set of 6: rectangular block (75 mm x 50 mm x 15 mm thick), semi-circle (90 mm base x 15 mm thick), equilateral prism (75 mm sides, 15 mm thick), double-convex lens, (90 mm long, 23 mm at center), and 2 double-concave lenses (90 mm long, 10 mm at center). **SB28593 – \$52.95**



Flexible and cuttable

Mirrors

Flexible, two-sided plastic mirrors. Three assorted sizes: 7 1/2" x 6", 4" x 3", and 3" x 2". Customize with scissors. Pkg. of 12. **SB23588 – \$29.95**



BEST SELLER

Lens and Prism Set

Large prisms and lenses. One side is frosted to aid in revealing the path of light. Set of 7. **SBI0977 – \$44.95**



Giant Water Prism

Throws a spectrum up to 78 3/4" (2 m) long. When filled with water, mineral oil, or another fluid through integrated lid with hole, 16"H right angle prism will display a huge, brilliant spectrum. Will not leak under normal use, rot, rust, warp, or become opaque. Works best with sunlight or a bright laboratory lamp. 1/4" acrylic. **CHOKING HAZARD (1).** Not for under 3 yrs. **SB49112 – \$44.95**



LED Light Box and Optical Kit

Gr. 5+ Plastic three-ray, dual-color light box with 3 individual switch controls; 12 clear acrylic prisms and lenses in different shapes and sizes; and 9 activity cards. 4 5/16" x 2 3/4" x 1 1/4". Uses 3 "AAA" batteries, not included. **SB50013 – \$59.95**



Light Box

Hinged sides with mirrors for mixing colors. Adjustable lens makes divergent, convergent, or parallel rays of light. Grooves for slit plates or color filters. 8 acrylic plastic blocks, 8 mounted color filters, 2 slit plates, 3 mirrors, set of colored cards, and spare bulb. Requires 12V battery or 12V power supply (not included). **SB37306 – \$121.00**



Demonstration Lens Set

50 mm dia. acrylic lenses. Double convex, double concave, plano convex, plano concave, concavo-convex, and convexo-concave. Set of 6. **SB28594 – \$23.50**



Lenses Demonstration Set – 50mm

Plano-concave, convex-concave, double-concave, concave-convex, double-convex, and plano-convex lens types with ground safety edges. Sets of 6. **S00169 – \$12.50**



Refraction Block

Acrylic. All sides polished. 115 mm x 65 mm x 20 mm. **SB28595 – \$7.55**



Refraction Cell – Rectangular

Clear acrylic refraction cell. Uniform wall thickness eliminates distortions. **SB52168 – \$8.00**



Optical Bench Set

Gr. 7+ Optical elements mounted in protective frames with mounting rods. Four captive riders have index mark and set screws to secure rider and optical elements. Precise parallel bar optical bench with scale is 37 3/4" x 4 3/4" x 4 3/4". Prefocused illuminator with 12V/6 W incandescent lamp, 4 lenses (2" dia.), 2 mirrors, object diaphragm, 2 screens, and manual. **SB43479 – \$133.95**



Economy Optics Kit

Gr. 6+ Double convex lens (glass, 38 mm dia.), double concave lens (glass, 38 mm dia.), plain lens (glass, 38 mm dia.), clear glass screen, 2 acrylic mirrors (square), white plastic screen, 5 cellophane squares in 5 colors, 3 lens/mirror supports, 2 acrylic prisms (equilateral, 25 mm x 50 mm), plastic graduated beaker, flashlight, candle, and activity guide with 20 experiments. **SB31097 – \$48.95**



SB50689



SB42623

Disposable Penlight

High-impact molded styrene. Can be clipped on pockets. 4 1/2". **SB50689 – \$3.95**

Flashlight Classroom Pack

Plastic outer casing. Diamond reflector for wide beam of light. No color choice, color may vary. Pack of 12. Each flashlight uses 2 "D" batteries, not included. **SB42623 – \$53.95**

Flashlight Only

SBI3626 – \$5.00
Batteries. Size "D." Pack of 2. **SBI0826 – \$4.90**

Laser Optical Disc Set

Gr. 6+ Laser ray box projects 1, 3, or 5 parallel bright beams. Substantial vinyl template with degree circle and linear scale forming optical disc. 7 clear acrylic optical elements. Mirror with adjustable curvature. Acrylic element bottoms are frosted to show ray paths. International AC adapter, 15" x 8¼" magnetic activity mat, user's manual, and plastic case. **SB45835 – \$107.95**

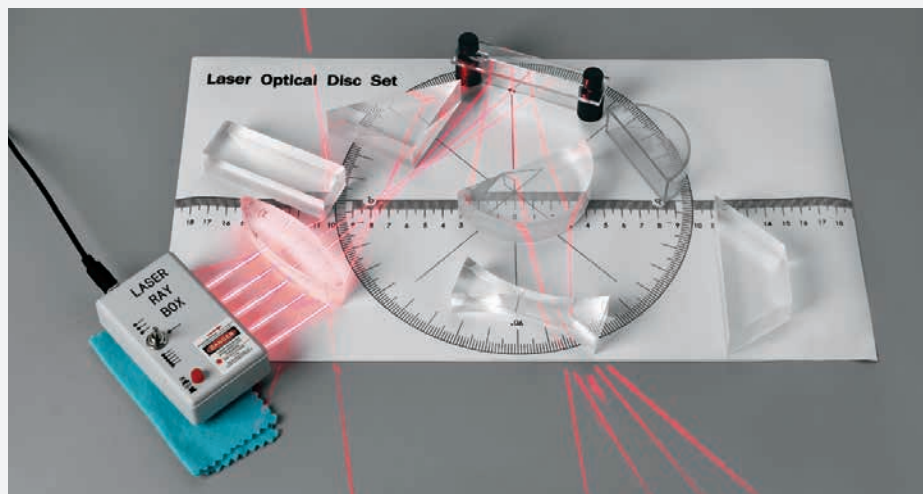

Concept of Light Kit
Gr. 6–8 Safe, hands-on, inquiry-based experimentation into the nature and properties of light. Provides instructions for science fair activities and optional Proeware/Data Logging activities. **SB42282 – \$145.00**



United Scientific Lumirod Light Pipe
Gr. 5+ Visually demonstrate the principle of fiber optics in the lab with this light pipe. This curled and clear acrylic rod conducts light by internal reflection. Use a flashlight or a green laser pointer when demonstrating. **SB49816 24" L – \$24.95**
NE30303 48" L – \$38.25



Laser Pointer Key Chain
2½". Colors may vary. **CHOKING HAZARD (I).** Not for under 3 yrs. **SB47407 – \$1.95**
"AAA" Batteries. Pkg. of 4. **SB27438 – \$3.49**

Includes comprehensive teacher guide!

Nasco Properties of Light Kit
Gr. 4–8 This kit includes hands-on experiments that cover basic facts about how light travels including: sources of light, shadows, transmission of light, and more. Includes teacher's guide and materials needed to complete each activity. **CHOKING HAZARD (I).** Not for under 3 yrs. **NE30086 – \$99.95**



ONLY AT NASCO

Newton's Color Disc
Rotate disc to show that white light is composed of the 7 colors of the spectrum. Disc is attached to pulley mounted on metal stand driven by belt and hand-driven wheel. May come with a metal or heavy cardboard disc. **SB45057 – \$38.25**



Acrylic Color Filters
Use with overhead projector to demonstrate that a material's color depends upon the color of the light it is capable of reflecting, and the color of the light incident upon its surface. 2¾" x 2¾". **SB14384 – \$3.55**



BEST SELLER

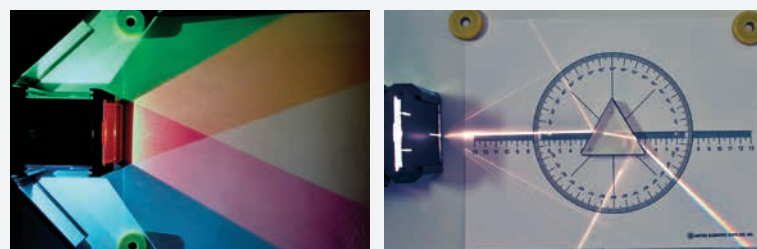

Whiteboard Optics Set
Gr. 7+ Set of ray optics and color experiments using magnetic-backed components. Use on any installed steel whiteboard. Double-ended light box with cylindrical lens and slots for mounting 3 slip diaphragms for ray optics on one side. Other end carries 2 adjustable mirrors and an open area for color mixing work using colored filters that fit into slots in ray box. **CHOKING HAZARD (I).** Not for under 3 yrs. **SB52172 – \$282.00**



Seeing the Light Kit
Gr. 5–8 Explore the behavior of light, including color mixing, reflection, refraction, and the bending of light. For 1–3 students. **SB50540 – \$28.00**

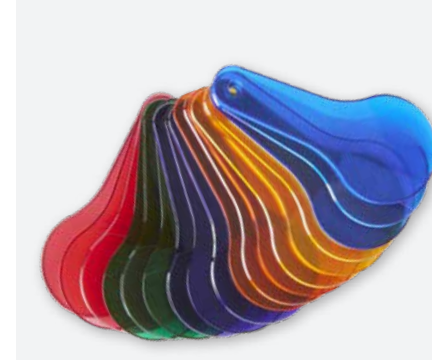

Color Paddles
Transparent 6" paddles in 6 colors with 3 textures demonstrate the principles of color mixing. Set of 18. **9712420 – \$8.50** 6+ \$7.65

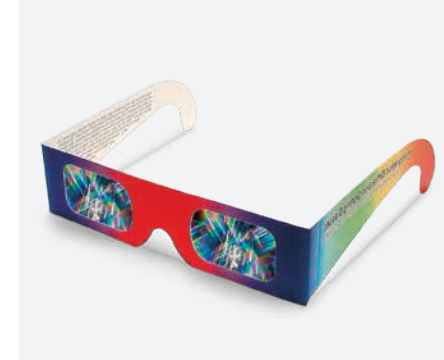

Diffraction Grating Glasses
13,500 lines per inch, double axis holographic diffraction grating lenses separate light from any source into its spectral components. Set of 6. **SB49296 – \$4.95**

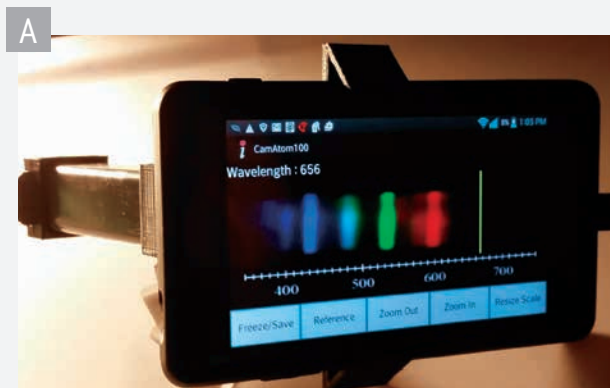

SB52271



SB53180

A. Spectroscopes

Give your device the ability to identify and characterize substances. Make measurements in real time. Calibrated with adjustable slit and zoom. Adjustable clip and downloadable app.

Smartphone Spectroscope. Works with any smartphone.
SB52271 – \$68.95

iPad® Spectroscope
SB53180 – \$88.95

B. Reflection and Refraction Demonstrator

Gr. 7+ This 6⁵/₁₆" dia. acrylic water tank has a 360° scale and movable arm with laser activated by push button. Thumb screws on side of laser harness can be adjusted to finely position laser beam. **NOTE:** This emits laser light. Max. output power <1mW. Wavelength: 630-680 nm. Class II laser product. Uses 2 "AAA" batteries, not included.

SB52562 – \$88.95

C. Color Mixing Demonstration

Demonstrate color mixing with red, blue, and green. Color brightness can be controlled by individual switches. 4¹/₈" x 3³/₈" x 4¹/₄" with 3" screen. Uses 3 "AA" batteries, not included.

⚠ **CHOKING HAZARD (I).** Not for under 3 yrs.

SB47548 – \$52.95

D. Wavelength and Spectrum Demonstrator

Gr. 7+ Discover how colors affect wavelengths and learn why red is chosen for "stop" in traffic signals. 11 color and wavelength LEDs mounted in 12" x 1³/₁₆" dia. metal tube with 3¹⁵/₁₆" dia. metal base. Rotary switch on top lights up each LED individually.

SB48327 – \$101.95

E. Periodic Table of Spectra

Gr. 8+ High-resolution periodic table poster shows detailed emission of spectra for each element. Laminated. 1.5 mil. 24" x 36".

SB52402 – \$39.95

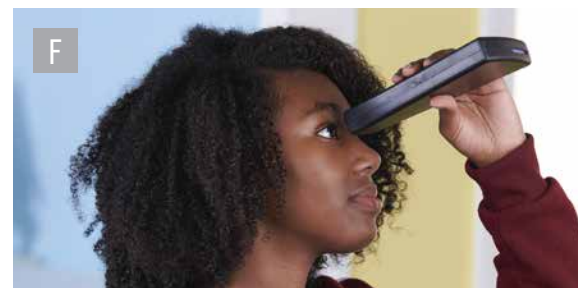

F



G

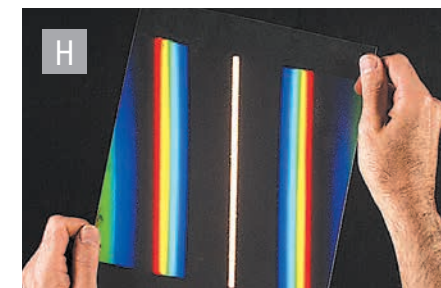

H

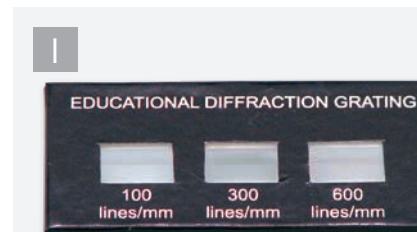

I



J



K



L

F. Quantitative Spectroscope

Investigates bright line spectra to unveil the atomic origin of light. Measure wavelengths of visible light from 4,000–7,000 Angstroms with the precision of ±50 Angstroms using built-in scale.

SB33518 – \$10.95

G. 6" Mini Blacklight

Requires 4 "AA" batteries (not included).

EL12235 – \$9.95

H. C-Spectra® – An Instant Spectroscopy

View light through C-Spectra® and the spectrum will be clearly visible. Every segment produces the same pattern. When cut into 1³/₄" squares, each 6" x 12" sheet provides approximately 18 pieces.

SB23811 – \$24.95

I. Educational Diffraction Gratings

Three diffraction gratings mounted on same slide: 100, 300, and 600 lines per mm. Individual gratings: 1/2" x 3/8". Slide: 3" x 1¹/₄".

SB45751 – \$35.95

J. Replica Diffraction Grating Slides

Gratings are mounted in a 2" x 2" slide frame. 13,500 lines per inch. Pkg. of 25.

SB26512 – \$10.95

K. Digital Lux Meter

Checks luminance level. Range: 0–50,000 or 0–100,000 Lux with 0.4 second sampling time. High accuracy, accurate response, auto zeroing, over-range indication, 1/16" LCD display, data hold, and low battery alert. Operating temperature: 32° to 122° F (0° to 50° C). Estimated battery life: 200 hours. 4³/₈" x 2¹/₁₆" x 1³/₁₆". Requires 1 "9V" battery (not included).

SB50326 – \$46.50

L. Project Star Precision Spectrometer

Gr. 9+ With actual wavelength measurements and equivalent energies in electron volts, tool enables students to identify different elements in various light sources. Plastic.

SB26055 – \$36.95



Spectrum Tube Power Supply

Provides safe and reliable operation for spectrum discharge tubes approximately 10¹/₄". Supplies a voltage that prolongs spectrum tube life. Sockets eliminate electrical shock hazards. Universal plug included. RoHs and CE certified. Unit operates at both 110V-130V and 210V-230V.

SB43813 – \$190.00

Spectrum Tubes. Demonstrates spectral lines. 10¹/₄" glass tubes with capillary portion between 3¹/₂"–4" and can be varied as required. Electrode sealed in each end and attached to metal end cap with loop for hookup to wire connections.

- SB44679 Hydrogen
 - SB44681 Helium
 - SB44682 Nitrogen
 - SB44683 Oxygen
 - SB44684 Water Vapor
 - SB44685 Air
 - SB44686 Carbon Dioxide
 - SB44687 Neon
 - SB49245 Krypton
 - SB48893 Argon
 - SB48894 Xenon
 - SB48896 Mercury
- Each – \$40.95



B



C



D

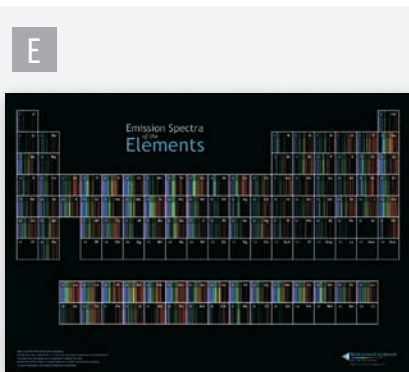

E

Don't see it here?
Find it at
nascoeducation.com

BEST SELLER



For individual tuning forks, go to nascoeducation.com

Aluminum Alloy Tuning Forks

Smooth, aluminum-turned handles approximately 1 3/4" L. Nonmagnetic. Requires no plating. Will not rust or corrode. Scale letter and frequency stamped on each fork. Accurately tuned within ±.5% at 20° C. Weighs 1/3 that of steel forks. Class A-3, tuned to Physical Scientific (C-256).

Tuning Forks — Student Grade, Set of 4. 256, C'; 320, E'; 384, G'; and 512, C".
SBI6561 — \$12.50

Tuning Forks — Student Grade, Set of 8. 1256, C'; 288, D'; 320, E'; 341.3, F'; 384, G'; 426.7, A'; 480, B'; and 512, C".
SBI6562 — \$24.95

Set of 8 Tuning Forks with Mallet. Tuning Forks — Set of 8 (SBI6562, above) and mallet (SA01602, below).
SB48580 — \$24.50

Mallet Only. 1" dia. hard rubber ball, 1/4" plastic handle, length 8".
SA01602 — \$2.95

Tuning Forks, Set of 13 — Student Grade
Frequency and scale letter stamped on each fork. Aluminum alloy.
SB29986 — \$37.95



Resonance Apparatus
Provides data needed to determine wavelengths and velocity of sound. End of 90 cm graduated plastic resonating tube is connected to aluminum reservoir that slides along vertical support rod to raise water level to any level. Produces resonances for 1/4, 3/4, and 5/4 wavelengths of a 512 VPS (not included).
SBI6555 — \$102.95



Super Slinky® and Stand
Extra long Slinky® spring (stands 13 cm high when compressed) allows students more time to observe wave behavior.
SB39354 — \$40.95



Tuning Fork Activator
Protect tuning forks as well as your desk from nicks and scratches. Solid rubber. 2 1/2".
SB39153 — \$3.75



7-Frequency Adjustable Tuning Fork
Weights adjust to deliver fine tones in C128, D144, E160, F170.7, G192, A213.3, and B240 frequencies. Scale letters on stem. Precision-grade aluminum. 8".
SBI4269 — \$15.50



Wave Demonstrator Set
This 4' Slinky® spring with 3 times the normal length demonstrates several fundamentals of wave motion. Spring extends to 30'. Longer and heavier 6' helical spring demonstrates the effects of greater mass and of greater tension.
SBI3636 — \$25.95
3" Dia. Metal Slinky® Spring
SBI3633 — \$6.75
6' Metal Helical Spring
SBI3634 — \$15.75



Resonant Tuning Forks Set
Without the weights, forks illustrate sympathetic vibration at distances. With the weights, one fork can be tuned one or more cps different. These 32 mm, chromium-plated steel, 440 Hz tuning forks are mounted on hardwood resonance boxes.
SA01604 — \$70.50



Aluminum Wave Model
Eccentric discs support a series of rods joined to a handle that is turned to simulate longitudinal and transverse wave motion. Mounted on polished wooden base.
SB33592 — \$86.95



United Scientific AdvancedGen Acoustic Resonance Apparatus
Investigate resonance phenomena of many frequencies with this new and improved apparatus. Explores the acoustic resonances of an enclosed air column. Water level can be adjusted with millimeter precision. Includes air pump and Bluetooth speaker.
NE30448 — \$490.95

For 220V adapter, go to nascoeducation.com



Spring Oscillation Experiment Set
Gr. 8+ Mount demonstration spring onto vibration generator to learn about oscillation and resonance. Vibration generator produces a low frequency mechanical oscillation with a range of 0.5 to 5,000 Hz and is powered by the audio generator, which generates between 0.1 and 200 kHz. Ring stand and clamp are needed but not included. **CHOKING HAZARD (I).** Not for under 3 yrs.
SB47843 — \$330.00

Vibration Generator with Spring Only. Requires additional materials to use: ring stand with clamp, signal generator, and banana plugs. **CHOKING HAZARD (I).** Not for under 3 yrs.
SB47666 — \$139.95
Audio Generator Only. Jack for a 5.5-watt speaker, cord to plug into wall outlet, and BNC to banana plug cord. 110V AC. **CHOKING HAZARD (I).** Not for under 3 yrs.
SB46992 — \$199.95

BEST SELLER



Nasco Sound Kit
Gr. 4–8 Specific concepts are investigated to develop ideas about how mechanical energy converts to sound, how the use of resonating tubes and temperature can be used as a direct measurement, and how the characteristics of sound waves, frequency, wavelength, loudness, and the velocity of sound make an impact in discovering the world around us. Aligned with NGSS.
Sound Multi-Group Kit. For 6 work stations. **CHOKING HAZARD (I).** Not for under 3 yrs.
SBI7861 — \$280.00
Sound Demonstration Kit. For 1 work station or classroom demonstration. **CHOKING HAZARD (I).** Not for under 3 yrs.
SBI9239 — \$79.95

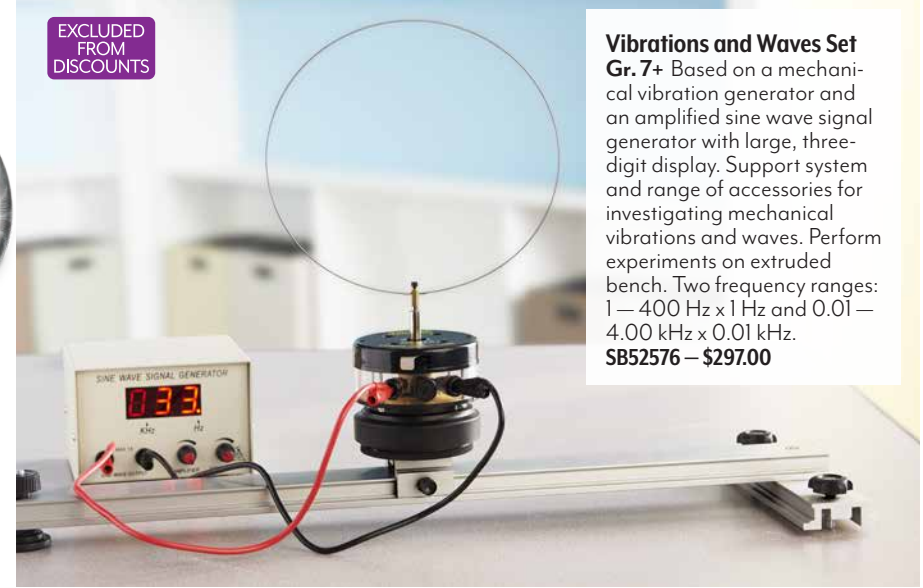

EXCLUDED FROM DISCOUNTS

Vibrations and Waves Set
Gr. 7+ Based on a mechanical vibration generator and an amplified sine wave signal generator with large, three-digit display. Support system and range of accessories for investigating mechanical vibrations and waves. Perform experiments on extruded bench. Two frequency ranges: 1–400 Hz x 1 Hz and 0.01–4.00 kHz x 0.01 kHz.
SB52576 — \$297.00

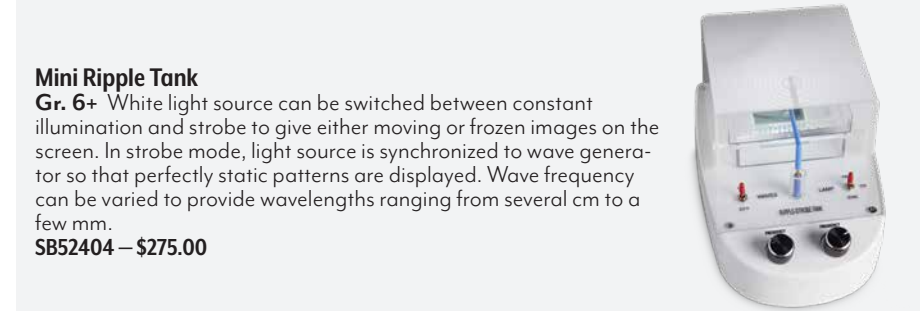

Mini Ripple Tank
Gr. 6+ White light source can be switched between constant illumination and strobe to give either moving or frozen images on the screen. In strobe mode, light source is synchronized to wave generator so that perfectly static patterns are displayed. Wave frequency can be varied to provide wavelengths ranging from several cm to a few mm.
SB52404 — \$275.00



Resonance Bowl with Mat

Rub copper handles. Vibrations make water surface ripple. Soon, water droplets shoot up and become continuous fountain streams. Silicone material and mat's honeycomb design stop bowl from slipping and prevent vibrations from transferring to table. 7" mat withstands temperatures up to 480° F (250° C).

SB52596 – \$149.95

Resonance Bowl Only
SB51123 – \$154.95

Mat for Resonance Bowl Only
SB51122 – \$9.95



Ripple Tank for Overhead Projector

Gr. 5+ Observe propagation, reflection, interference, and diffraction of waves. Plexiglass. Adjustable vibrator, water tank, 2 baffles, and adjustable control knob. 13" x 11 3/8" x 1 1/2".

SB42192 – \$137.50

BEST SELLER

Nasco Electricity Value Pack

Includes 66 clip leads and 20 each of lamp sockets, 1.5V lamps, "D" cell battery holders, "D" cell batteries, and single-throw switches. For class of 40 students working in pairs.

SB42846 – \$189.95



A



B



C



D



E



F



G



H

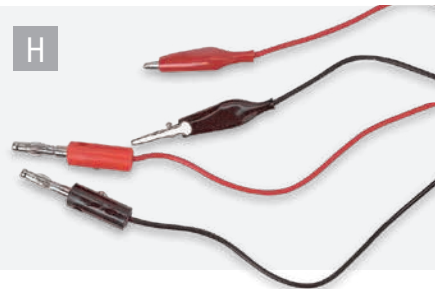

Energy Ball

Touch two metal strips simultaneously to turn your body into a path to a complete circuit, causing the ball to flash brightly and make an eerie sound.

SB28883 – \$6.00



Two-Potato Clock

Demonstrates the principle of an electrochemical cell. LCD clock runs on two potatoes, oranges, grapefruits, or cans of soda.

⚠️ CHOKING HAZARD (1). Not for under 3 yrs.
SB16423 – \$22.95

NEW

United Scientific Digital Sound Level Meter

Measuring range: 30 dBA – 130 dBA. Accuracy: ±1.5 dBA. Resolution: 0.1 dB. Frequency response: 31.05 Hz – 8 KHz. Sampling rate: 2 times/s. Features max/min hold, backlight display, low battery indication, and auto power off. Uses 9V battery (included). 2" x 1 1/2" x 5 1/2".

NE30534 – \$45.50



Energy Stick

Gr. 2+ Hold the stick in your hands and see if it lights up and makes noises.

SB48146 – \$8.95

Energy Transfer Kit

Gr. 6+ Series of activities based on waves, light, and sound, including producing longitudinal and transverse mechanical waves and comparing similarities and differences; observing wavelength and frequency in water; and more.

SB47796 – \$140.00



A. Series 2000 Type (PE) Plain Enamel Copper Magnet Wire

Solid bare copper conductor wire with oleoresinous (plain enamel) insulation. Temperature: -30° to +80° C. Characteristics: MIL-W-583 Class 80.

Product No.	Description	Gauge	Length	Each
SB10515	1-lb. Spool	18	195'	\$32.95
SB42921	1-lb. Spool	20	79'	\$8.25
SB10517	1-lb. Spool	22	500'	\$32.95
SB10518	1-lb. Spool	24	790'	\$32.95
SB10519	1-lb. Spool	26	1,260'	\$32.95

B. PVC-Covered Copper Connecting Wire

Use when high conductivity with negligible loss is essential. PVC-coated copper wire.

Product No.	Description	Gauge	Length	Each
SB10520	10-oz. Roll, White	22	100'	\$8.15
SB10521	10-oz. Roll, Black	22	100'	\$8.15
SB10522	10-oz. Roll, Blue	22	100'	\$8.15
SB10523	10-oz. Roll, Red	22	100'	\$8.15
SB40515	10-oz. Roll	20	100'	\$12.95

C. Insulated Alligator Clips

5 black and 5 red clips with insulated handles. Pkg. of 10.
SB23790 – \$7.50

D. Fahnestock Clips

For 1 wire. With screw hole. Pkg. of 100; 3/4" x 5/16".
SB19192 – \$15.70

E. Alligator Connector Cords

Flexible, plastic-covered wire with alligator clips at both ends (3 red and 3 black). Pkgs. of 6.
SB13984 12" – \$7.95 SB13985 24" – \$8.95

F. Alligator Lead Set

Alligator leads in 5 colors. 14" cords. Set of 10.
SB51195 – \$10.95

G. Banana Plug Cords, Stacking Type

Two-way stack plugs are at both ends of flexible coated wires (3 red and 3 black). 24" cords. Pkg. of 6.
SB13988 – \$16.50

H. Banana Plug Cords with Alligator Clip

Flexible, plastic-covered with a banana plug at one end and alligator clip with protective vinyl sheath at other. Pkgs. of 6 (3 red and 3 black). 12".
SB13990 – \$12.15

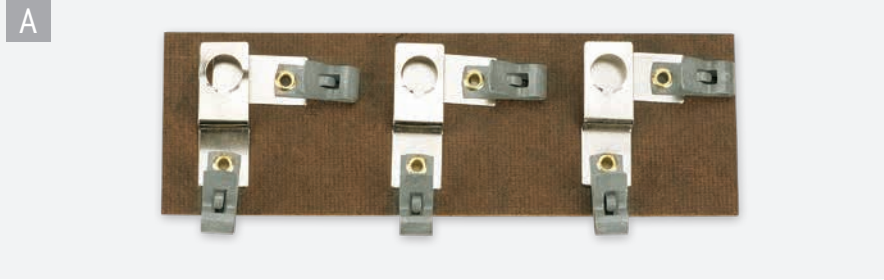

Wire Stripper
Heavy-gauge steel. 5" tool strips 10–24 gauge wire and trims copper wire up to 10 gauge. Permanent black finish with PVC grip handle. 8"L.
SB27693 — \$4.95

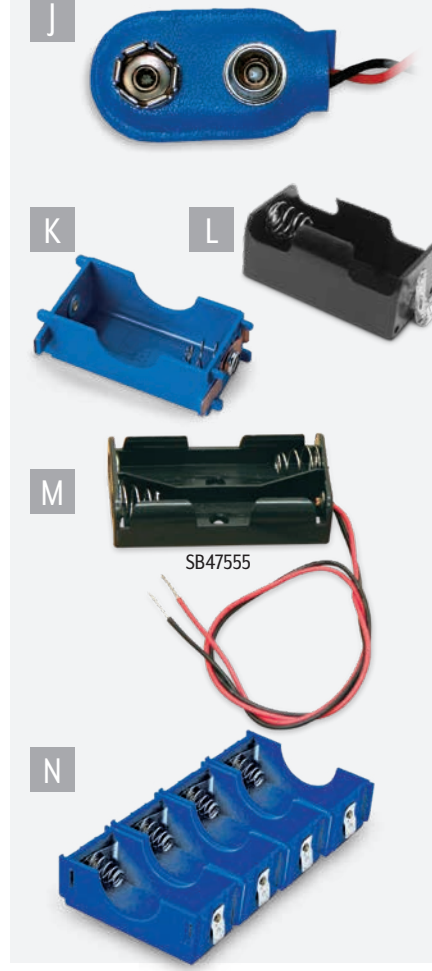

J. 9 Volt Battery Connector
5/8" (15 cm) red and black leads with insulated snap-in connector.
SB41221 — \$1.65

K. Battery Holder/Joiner
Holds a standard "D" size cell battery. High-impact plastic with male and female button snaps on ends. Extensions on sides allow instant connections in series or in parallel without using leads.
SB19023 — \$2.95

L. Battery Holder
Fahnestock clips attached at each end. D-cell snaps into plastic holder, which can be joined for series or parallel circuits.
SB41216 — \$1.55

M. Battery Holders
Comes with a 12" wire.

Product No.	Cell Holder	Cells	Price
SB47555	AA	2	\$1.05
SB47556	AA	2 with Switch	\$1.55
SB47551	D	1	\$1.55

N. Plastic "D" Battery Holder
Pack of 4 "D" detachable battery holders that secure 4 batteries in parallel or series.
SB45491 — \$6.50



Nasco Bucket O' Batteries
Pack of 48 "D" batteries in storage bucket with lid.
SB42845 — \$61.95

Nasco Bucket O' Batteries with Holders
20 "D" batteries, 15 battery holders, and storage bucket. For 15–30 students.
SB42844 — \$42.95



Battery Holders
Comes with 12" wire and alligator clips attached. 26 gauge wire.

Product No.	Size	Cells	Each	10+
SB53286	AA	1	\$1.50	\$1.35
SB53287	AA	2	\$1.95	\$1.75
SB53288	C	1	\$1.95	\$1.75
SB53268	D	1	\$2.95	\$2.65
SB53290	D	2	\$2.95	\$2.65
SB53291	9V	1	\$2.95	\$2.65

Alkaline Plus Power

1.5-Volt Plus Batteries

A much longer life than conventional carbon-zinc batteries. Batteries maintain a full-rated voltage for life. Battery brands may vary.

Product No.	Size	Pkg.	Price/Pkg.
SB27438	AAA	4	\$3.49
NE30593	AAA	8	\$5.19
NE30595	AAA	16	\$9.99
BE01291	AAA	24	\$13.99
SB10828	AA	2	\$1.89
BE01288	AA	4	\$3.49
NE30592	AA	8	\$5.19
NE30594	AA	16	\$9.99
BE01290	AA	24	\$13.99
SB10827	C	2	\$4.75
SB34663	C	4	\$7.65
SB10826	D	2	\$4.90
SB19164	9V	1	\$3.99
NE30596	9V	2	\$6.99



A. Miniature Lamp Bulb Holders
With 2 Fahnestock clips for connecting wires. No screwdriver required. Mounted on Masonite base. Components can be combined to form circuits of multiple lengths.

Product No.	Description	Each
SB17079	Single Holder	\$1.20
SB18058	Triple Holder	\$3.95

B. 5 Mini Lamp Circuit Board
Mounted on 4" x 11" styrene base with 10 connecting posts and 8 connecting links. Buss bars connecting receptacles allow for quick changing from parallel to series circuits and many combinations. 6V lantern battery recommended.
SB13995 — \$21.00

3-Lamp Circuit Board. Use with 6V maximum for safety. Mounted on 8" x 5 1/2" x 3/4" clear acrylic base for overhead projections.
SB31102 — \$26.50

C. Miniature Bulb Holders
Metal components mounted on 1 3/4" dia. plastic base. Bulb not included. Pkg. of 10
SB27439 — \$12.95

D. Receptacle for Miniature Lamps
Plastic base with metal insert. Screw terminals. Pkg. of 10.
SB18052 — \$13.50

E. Metal Lamp Holders
Miniature sockets with 2 terminals fit all miniature screw base lamps. Pkg. of 10. **CHOKING HAZARD (I).** Not for under 3 yrs.
SB46999 — \$4.65

F. Brass Knife Switch
Brass poles and knives. Single throw and single pole. Pkg. of 10.
SB09736 — \$15.00

G. Knife Switches
Bakelite knife switches with easy-to-use spring or screw binding posts. Single throw and single pole.
SB27551 — \$2.00
SB25237 Pack of 20 — \$39.95

H. Miniature Lamps
Screw base. For miniature lamp holders on this page. Pkgs of 10.
S09288 1.5V — \$4.00
S09289 2.5V — \$4.00
SB52273 6.3V — \$6.50

I. Miniature LED Lights 3.2V, 25mA. Pkg. of 10.
SB51117 — \$25.25

△ See page 3 for complete Choking Hazard Label Information.
◆ DOT hazardous material ◆ Subject to DOT hazardous material surcharge.



DC Generator
Can be utilized with almost any experiment requiring up to 6V DC current. Can also be used as a hand-generated flashlight due to mounted lamp on the end, or use the binding post to connect an outside electrical circuit. Plastic.
SB35036 — \$17.25



United Scientific Wimshurst Generator
Gr. 5+ Demonstrate high voltage electric charges with this high-quality generator. Features acrylic rotating disks, foil strips and brushes, insulated cylindrical capacitors, and a durable plastic platform. For classroom demonstrations, it will produce large sparks.
NE30304 — \$197.95

EXPLORE ELECTRICITY
IN ACTION
with hands-on activities

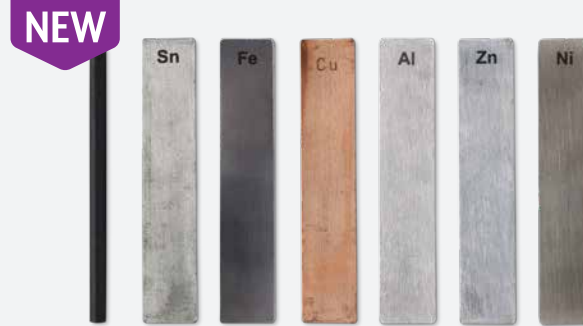

Metal Electrodes - Set of 7
Set of 7 includes 1 rod of carbon and 1 stamped strip each of aluminum, copper, zinc, nickel, tin, and iron. Strips measure 4" x 3/4".
NE30485 — \$28.75

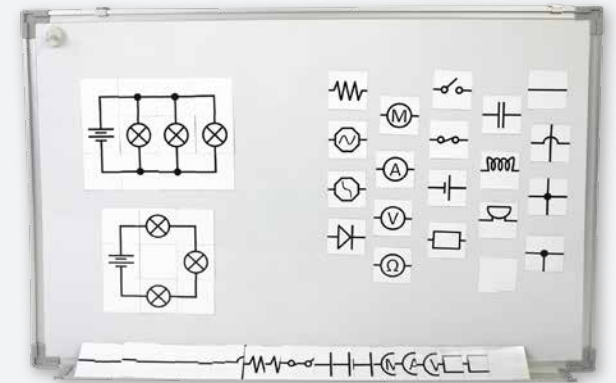

Stick to Science – Circuits
Gr. 7+ Teaches common electrical circuit components and how to sort them. 78 magnetic pieces and teacher's guide with example activities.
SB53072 — \$19.95



World's Simplest Motor
Motor kit demonstrates the basic principles of electro-magnetism. CHOKING HAZARD (1). Not for under 3 yrs.
SB26058 — \$8.99

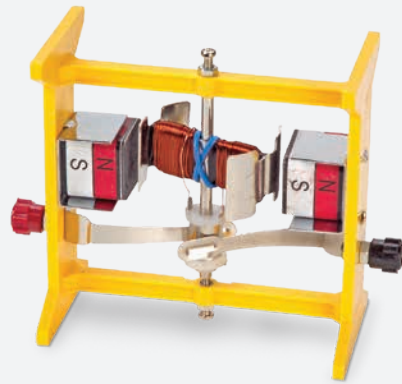

DC Motor
Magnet polarity can be reversed. Can also be used with a rheostat to observe the change of speed with the change of current. Can operate on a 1.5V battery.
SB30029 — \$14.50



Plasma Globe
Touch of the hand causes streams of "electrically" charged particles to leap harmlessly within sealed globe. Responds to music and voice. The globe is 4" dia. and overall 8"H. UL listed. AC adapter included.
SB48449 — \$22.95



Individualized Science Module – Mini Electricity Kit
Gr. 3-8 Create electrical circuits using energy stored in batteries to light a bulb and ring a doorbell. For 4-8 students.
SB27593 — \$45.95



AC/DC Generator Demo Set
Banana plugs can be inserted into different connectors to change from AC to DC. 10" x 7" x 9".
SB47753 — \$55.95



Genecon Handheld Generator
Generates up to 12V DC. Handle with reinforced thumb grip and longer lead wire that is color coded (red and black). Reinforced internal gears improve longevity of the unit. CHOKING HAZARD (1). Not for under 3 yrs.
SB48089 — \$67.95



1" Dia. DC Motor
Operates from 1.5V to 3V at .5V with no-load 80 to 90mA. .5 stall 200mA. Low torque; high rpm. 1" dia. x 1 1/2"L. 2 mm shaft.
SB18068 — \$4.95

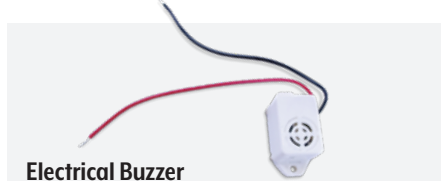

Electrical Buzzer
Includes 1 red and 1 black lead (4" each). Works with 1.5V, "AA," "C," or "D" batteries. Buzzer housing includes 2 screw holes for mounting. 1/2" x 1" x 1/2". CHOKING HAZARD (1). Not for under 3 yrs.
SB47558 — \$4.15



DC Motor with Alligator Leads
Voltage requirements: 4.5 to 6.0 DC volts. Red and black connector cord with insulators. 3"L.
SB39321 — \$4.95



CaddyStack Electricity Kit
Includes 16 bulb holders, 16 switches, 16 miniature bulbs, 30 wire connectors, 16 battery holders, 16 "D" cell batteries, 2 motors, 2 buzzers, 32-page teacher's guide, and plastic tote. For 15-30 students. CHOKING HAZARD (1). Not for under 3 yrs.
SB32922 — \$143.95

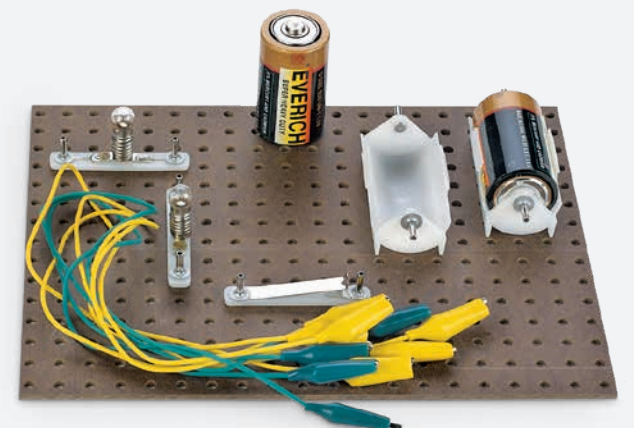

Individualized Science Module – Simple Circuits Kit
Gr. 3-8 Construct simple electrical circuits with or without a switch to learn about the flow of electrical current. For 4-8 students.
SB27587 — \$26.50



Snap Circuits® MyHome Kit

Gr. 3+ Students can build a house with real functional 3D circuits, just like the ones they use every day, and learn all about how they work. Includes 60 pieces and an illustrated, full-color manual with 25+ projects. ⚠ CHOKING HAZARD (1). Not for under 3 yrs. **NE30431 — \$79.95**

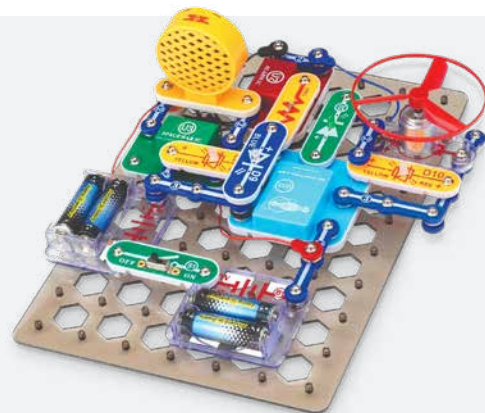

Snap Circuits® Discover Coding Kit

Gr. 3+ Build projects with lights, sounds, and a motor and control them with a smartphone or tablet. Includes over 30 pieces, Bluetooth-powered SC Controller, 5 control outputs, and an illustrated, full-color manual. ⚠ CHOKING HAZARD (1). Not for under 3 yrs. **NE30432 — \$94.95**

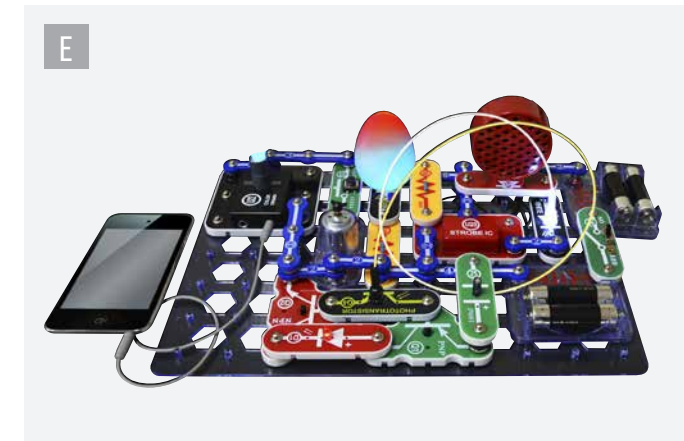
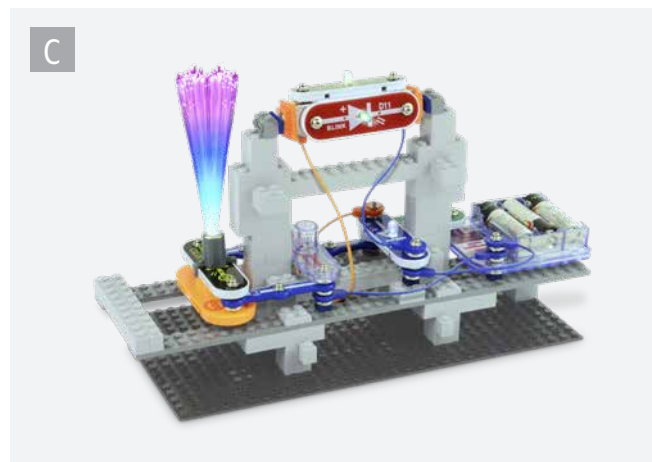
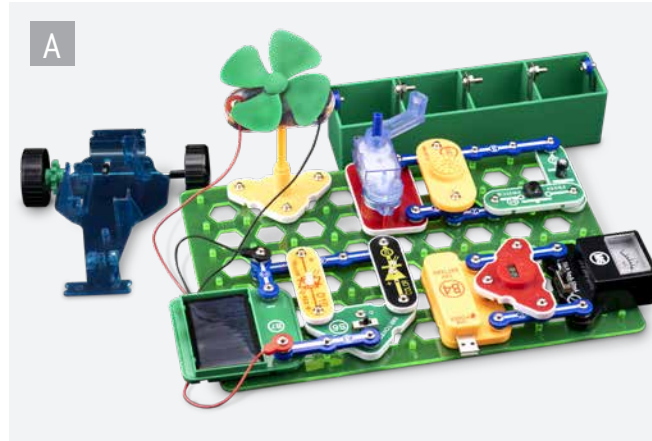

Snap Circuits® STEM Kit

Gr. 3+ Dive into STEM concepts with award-winning Snap Circuits! Projects explore magnetic fields, how the electricity in a home works, how switches control electricity, and more. Includes over 45 pieces and an illustrated, full-color manual with 85+ projects. ⚠ CHOKING HAZARD (1). Not for under 3 yrs. **NE30434 — \$58.95**



SB39455

Snap Circuits® Educational Kits

All kits include pieces and a manual. Kits with computer interface are the same as regular kits but include extra computer-interfaced projects.

Snap Circuits® Jr. Gr. 2+ 100 experiments. 30 pieces.

SB39452 In hard case — **\$70.95**

SB37731 In box — **\$44.95**

Snap Circuits® Classic. Gr. 2+ 300 experiments. 60 pieces.

SB39453 In hard case — **\$163.95**

SB37730 In box — **\$89.95**

Snap Circuits® Pro. 500 experiments. 75 pieces in a box.

SB39162 — \$125.95

Snap Circuits® Extreme. Gr. 2+ High-tech computer interfaced kit for more advanced students. Over 80 parts build over 750 experiments including voice recorder, IC FM radio module, analog meter, and more. Extreme Training Version also includes 138-page student guide and a teacher guide with quizzes. In cardboard box.

SB39455 Snap Circuits® Extreme — **\$189.95**

SB53355 Snap Circuits® Extreme

Training Version — **\$268.95**



Snap Circuits® STEM Classroom Activity Kit

Gr. 3–5 Get an entire circuitry unit in one convenient kit — created by teachers for teachers! The step-by-step curriculum walks through 10 days of open-ended activities. Includes 6 activity kits (support up to 18 students), 1 teacher's guide, 6 student workbooks (additional workbooks sold separately), detailed parts list and explanation, spare parts, traditional (pre/post/summative) and project-based assessments, presentation materials, summary sheet, and carrying case.

⚠ CHOKING HAZARD (1). Not for under 3 yrs.

NE30435 Classroom Activity Kit — **\$475.00**

NE30436 Additional Workbooks, Set of 6 — **\$37.00**



Want more? Scan to see all the extras at nascoeducation.com



ONLY AT NASCO

Nasco Current Electricity Kits
Gr. 5–8 Detect and investigate the direction of current flow and magnetic fields, batteries and chemical voltaic cells, series and parallel circuits, voltage, amperage, resistance, work done in electrical circuits, electrical heating effects, short circuits, and fuses. Aligned with NGSS.

Multi-Group. For 6 work stations. **SB50691 – \$440.00**

Demonstration. For 1 work station or classroom demonstration. **SB50150 – \$96.95**

Includes digital guide

SB50691

BEST SELLER

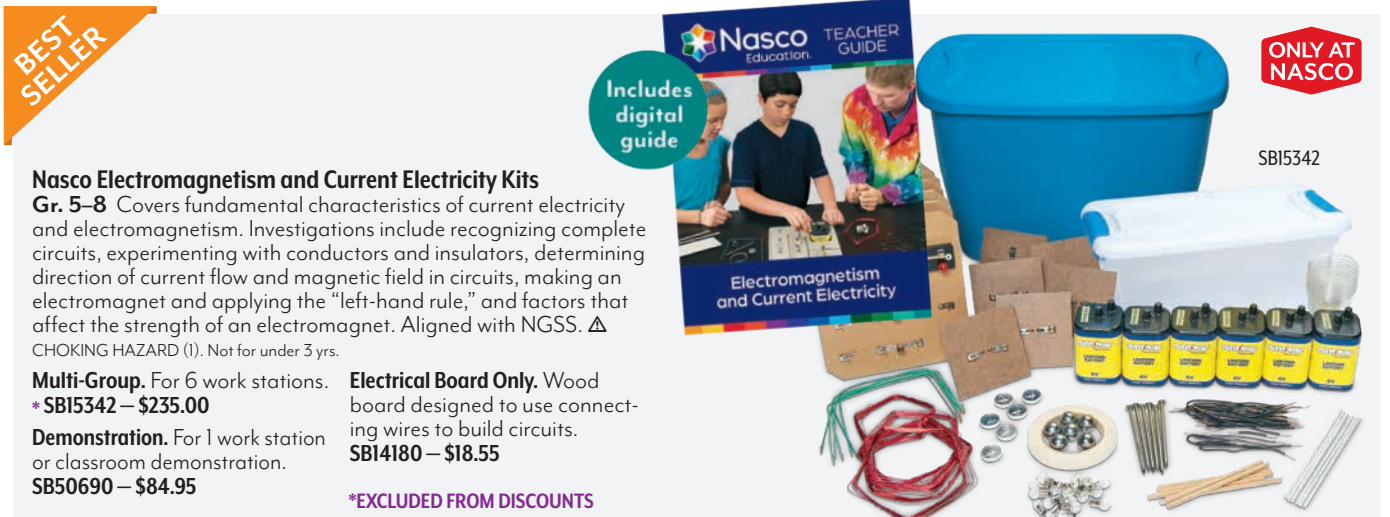

ONLY AT NASCO

Nasco Electromagnetism and Current Electricity Kits
Gr. 5–8 Covers fundamental characteristics of current electricity and electromagnetism. Investigations include recognizing complete circuits, experimenting with conductors and insulators, determining direction of current flow and magnetic field in circuits, making an electromagnet and applying the “left-hand rule,” and factors that affect the strength of an electromagnet. Aligned with NGSS. **CHOKING HAZARD (I).** Not for under 3 yrs.

Multi-Group. For 6 work stations. **SB15342 – \$235.00**

Demonstration. For 1 work station or classroom demonstration. **SB50690 – \$84.95**

Electrical Board Only. Wood board designed to use connecting wires to build circuits. **SB14180 – \$18.55**

***EXCLUDED FROM DISCOUNTS**

Includes digital guide

SB15342



ONLY AT NASCO

Nasco Bucket of Volts
Gr. 7+ Students test the voltage of cells and batteries, build and test different kinds of circuits and an electromagnet, and test the conductivity of common objects. Each of the 7 trays in the storage bucket contains all the components that 2 groups will need to complete the 4 included labs and additional optional experiments. Everything is reusable. Extremely fast construction of circuits using magnetic wire leads (Magleads®). Booklet contains 4 circuit experiments with lab sheets and 6 additional modifications. Instructor’s manual. All components are contained in a 7-gallon bucket with lid. For 28 students. **CHOKING HAZARD (I).** Not for under 3 yrs. **SB48577 – \$714.95**

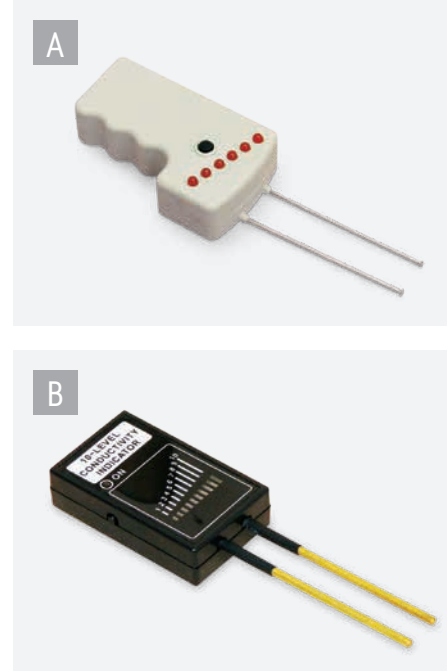

A

B



Building & Designing Batteries NextGEN STEM Kit
Gr. 7+ Contains 8 investigative activities that teach students how to use a multimeter to measure voltage and amplitude, calculate electrical resistance and electrode potentials, evaluate battery performance, assemble electrical circuits, and construct batteries. Main concepts covered include energy, matter, and electrochemistry. Enough materials for 40 students working in groups of 4, as well as a DVD, teacher and student guides, and digital content. Aligned to NGSS. **CHOKING HAZARD (I).** Not for under 3 yrs. **SB51335 – \$265.00**



Nasco Electrical Supply Set
 Includes 10 “D” cell battery holders, 10 bulbs (#41), 10 bulb sockets, 20 electrical clips, 10 knife switches, 100’ bare copper wire, 100’ insulated wire, and 5 wire strippers, all in plastic carry case. **SB27441 – \$79.95**



Get everything you need to explore circuits, currents, switches, and more

Nasco Student Electricity Assortment
Gr. 5+ Includes 10 mini lamp bulbs (1.5V), 10 Fahnestock clips, 3” x 4” plastic bag, 6 battery holders, 100’ of black-coated copper wire, 3 alligator connection cords, 3 banana plug cords, 6 bulb holders, 3 knife switches, 1 wire stripper/crimp tool, and flip top storage box. **SB45407 – \$39.95**

Conductivity Meters
 Compares conductivity of solutions, acids, or salts. Dip probes, press button, and note. LEDs give a quick visual comparison.

A. Conductivity Meter Tester. Compare conductivity in 6 levels. Red LEDs and 3/4” x 1/16” thick stainless steel probes. Total length with probes: 7”. Requires 2 “AA” batteries (not included). **SB48978 – \$17.50**

B. Conductivity Meter. Compare conductivity in 10 levels. Green LEDs and brass probes. 5 1/2” x 1/16””. **SB48330 – \$34.50**

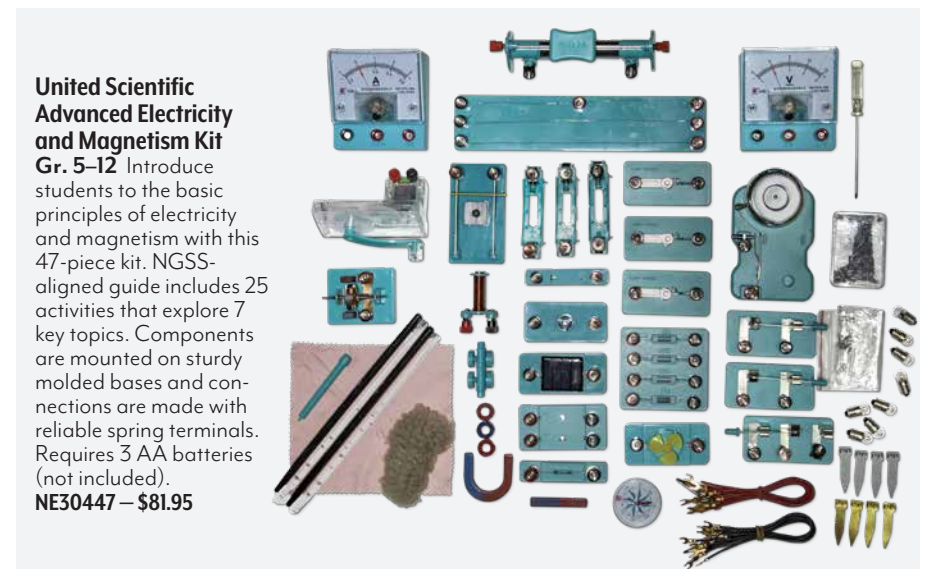

United Scientific Advanced Electricity and Magnetism Kit
Gr. 5–12 Introduce students to the basic principles of electricity and magnetism with this 47-piece kit. NGSS-aligned guide includes 25 activities that explore 7 key topics. Components are mounted on sturdy molded bases and connections are made with reliable spring terminals. Requires 3 AA batteries (not included). **NE30447 – \$81.95**



Replacement parts available at nascoeducation.com

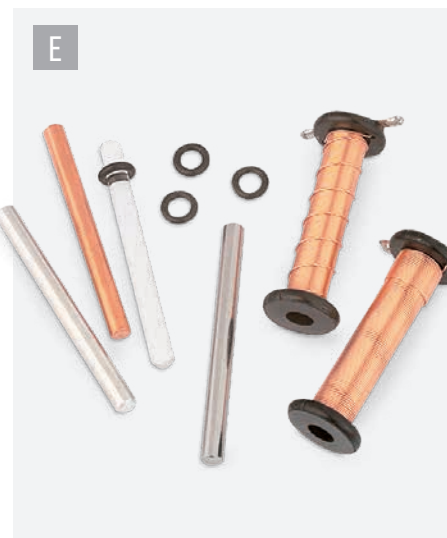
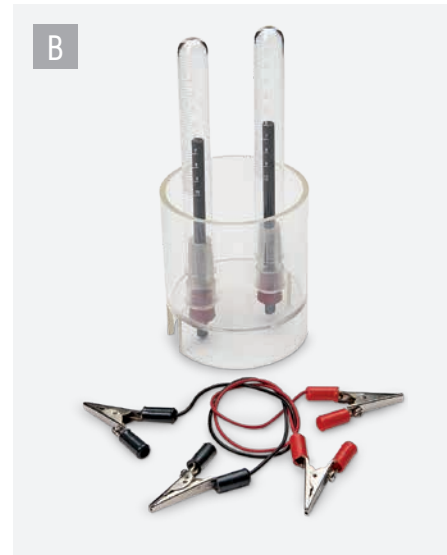

A. Hoffman Electrolysis Apparatus
Each graduated glass tube has stopcocks. Tubes are mounted on stand fitted with binding posts. Includes platinum electrodes. Use clamp SB18967 (p. 132) to hold center glass tube. Overall height: 2' (65 cm).
SB11120 – \$139.95

B. Electrolysis Apparatus
3" dia. x 2½" plastic container with mounted carbon electrodes. Container bottom has cutouts so leads can be connected to electrodes with ease. Total height: 3¾". 2 alligator clips (1 red, 1 black) and 2 graduated test tubes. Works on 12V DC. Replacement parts are available at nascoeducation.com.
SB52440 – \$25.95

C. 200 KV Electrostatic Generator
Gr. 5+ Generates 5" sparks. No shock hazard. 200,000V potential in humidities up to 90%. Neoprene belt lasts up to 500 hours (spare included). Plastic molded base and housing, 18 cm aluminum globe, PVC column, ground, and terminal. Already assembled. Uses 110V AC, 60 cycle.
SA05680 – \$202.95

D. Electromagnet Science Set
Materials for 6 projects and 40-page activity guide with instructions and glossary. For 1–4 students. ⚠️ CHOKING HAZARD (I). Not for under 3 yrs.
SB32806 – \$39.95

E. Electromagnet Experiment Set
Determine how the strength of an electromagnet is affected by the number of turns in the coil and the nature of the material that occupies the space inside the coil.
SB16533 – \$204.95

F. 400 KV Van de Graaff Generator
Gr. K+ Seamless, negatively charged, 12¾" dia. stainless steel globe for learning about static charge. 3" dia. column is made of shock-resistant, transparent butyrate. Sparks can reach up to 10". Operates in humidities up to 90%. 400,000V potential. Unit is 29".
SB40813 – \$715.00
Replacement Belt. Neoprene.
SB41227 – \$43.95

BEST SELLER

Student Meters – DC
Closed-back meters offer reliability, ruggedness, and affordability. 5½" x 3½" x 3⅞" plastic housing. Large 3¾" x 3⅞" clear plastic meter face has external zero adjustment. All meter movements are diode protected against overload. Five-way versatile binding posts. Accuracy ±2.5% of full scale on all models.

Product No.	Meter Type	Scale	Range	Each
SB26365	DC Voltmeter	Single	0-10V	\$10.50
SB26366	DC Voltmeter	Double	0-5/0-15V	\$12.50
SB26374	DC Ammeter	Double	0-1/0-5A	\$12.15
SB26381	DC Milliammeter	Triple	0-5/0-50/0-500mA	\$9.95



Individual Student Electrostatics Science Kit
Gr. 6–12 Whether students are learning in the classroom or from home, this kit allows them to explore static electricity. Help them create static electricity and the conditions where it appears. Kit includes: 3 rods (hollow glass, half-ground glass and ebonite); 3 balloons; 3 friction pads (flannel, silk, animal fur); and instructions.
NE30022 – \$24.95



Nasco Friction Rod Kit
Solid plastic rod, hard rubber rod, and hollow glass rod (closed at one end); 3 friction pads (flannel, silk, animal fur); balloons; and instructions.
SB13247 – \$27.95



United Scientific Digital Multimeter
Gr. 5+ Measure and verify multiple electric stimuli with this digital multimeter. This versatile and economical tool includes AC voltage, DC voltage, continuity, resistance, transistor, and battery test modes. Features digital LCD display. Complete with two 24" wire leads. 9V battery included.
NE30305 – \$9.95



Digital Multimeter
Extra-large 3¾" digit LCD display (4,000 count), low-battery display, floating decimal point, frequency counter (up to 10 MHz), AC and DC current (0-10A, 5 ranges), transistor hFE test, resistance (0-40MΩ, 6 ranges), low OHM continuity beeper, transistor hFE test socket, recessed input jacks, low power consumption, over range indicator, automatic polarity indicator, AC and DC voltages (600V, 5 ranges), capacitance (up to 200μF, 6 ranges), diode test function, capacitance test sockets, and input impedance 10MΩ on all ranges of AC and DC voltage measurement. Includes 2 leads with banana-clip ends and 2 probes. Protected three ways against accidental overloads.
SB27462 – \$52.95



Digital Multimeter
3½" digit LCD readout (2,000 count display). Transistor test, audible continuity test, diode test, 50 Hz signal injector (square wave), overload protection, and test leads. DC voltage range: 200mV, 2000mV, 20V, 200V, 600V. DC current range: 200uA, 20mA, 200mA, 10A. AC voltage range: 200V, 600V. Resistance range: 200Ω, 2000Ω, 20 KΩ, 200KΩ, 2000Ω. Input impedance: 1MΩ. 5" x 2¾" x 1".
SB26578 – \$21.95



A. Magnet Set
Includes steel horseshoe magnet, 2 ceramic bar magnets, 3 ceramic donut magnets, 4 metal squares, iron filings pack, lodestone, 2 magnetic compasses, and activity guide with 17 experiments.
SB31100 – \$41.95



B. AC/DC Variable Power Supply
DC output from 0–30V. AC output from 0–40V at up to 5 amps. Voltage adjust knob controls all three outputs. Volt and amp meters display setting. 7¾" x 12" x 5⅝".
SB45640 – \$275.95

C. Mighty Magnets
Plastic. Set of 6; 5".
SB38803 – \$26.95



D. Dowling Alnico Magnet Set
Includes 1" horseshoe magnet, 2" horseshoe magnet, 2" bar magnet, and tube of iron filings and steel shapes. **CHOKING HAZARD (I)**. Not for under 3 yrs.
SB45563 – \$24.99

E. United Scientific Float and Spin Magnet Demonstrator
This demonstration of magnetic repulsion uses a clear acrylic plate that keeps a levitating, spinning axle oriented above magnets built into the base of the apparatus. 2½" x 5" x 3". No batteries required.
NE30530 – \$8.50



F. The Remagnetizer™
Remagnetizes magnets that have lost their magnetism. Requires no electricity. Aluminum frame, steel base with mounting holes, and 2 permanent neodymium magnets.
SB22516 – \$77.95



G. Dowling Alnico Bar Magnets
Painted red and blue. 3".
SB49700 – \$14.95

H. Dowling Ceramic Magnets
Set of 2; 2" x 1" x ⅜" each.
SB33558 – \$6.95

I. Dowling Magnet Bars
Learn about magnetic polarity. Pair of red and blue magnet bars. Ceramic. 3" each.
SB39411 – \$7.99



J. Dowling Block Set Magnets
Plastic-encased magnets. Set of 12; 2" x 1" x ½" each.
SB45570 – \$15.99

K. Dowling Magnet Bars
South pole in blue. North pole in red. Pair; 7" x ¾" x ¼" each.
SB26074 – \$19.99



L. Chrome Bar Magnets
Two-plated chrome alloy magnets with marked poles. 6" x ¾" x ¼" thick. Pair.
SB15358 – \$22.50



M. Pair of Dowling Magnet Bars
South pole in white. North pole in red. Pair; 4½" x ½" each.
SB47138 – \$27.99



N. Alnico Bar Magnets
Powerful, painted magnets demonstrate magnetic properties and magnetic fields. Poles are marked.

Product No.	Size	Per Pair
SB26083	¼" x ½" x 1½"	\$7.95
SB14309	¼" x ½" x 2"	\$10.50
SB26084	¼" x ½" x 2½"	\$10.95

O. Neodymium Disc Magnets
The strongest magnet material available today. Magnetism guaranteed for life.

8 mm x 3 mm, Pkg. of 10. ⅝" x ⅛" thick.
SB38464 – \$9.95

12 mm x 3 mm, Pkg. of 6. ½" x ⅛" thick.
SB38463 – \$9.95

18 mm x 3 mm, Pkg. of 3. ⅞" x ⅛" thick.
SB38465 – \$9.95



P. Polished Alnico 5-Finish Magnet
½" dia. cow magnet.
C09784 – \$8.25

Q. Horseshoe Magnets
Strong steel magnets. North and South poles marked. Includes keeper.

Product No.	Size	Each
SB16070	3" (7.5 cm)	\$4.15
SB16071	6" (15 cm)	\$5.95

Dowling Ceramic Magnets Classroom Packs
Sets of 12 permanent magnets in 6 colors. **CHOKING HAZARD (I)**. Not for under 3 yrs.

R. Ring Magnets. 1⅛".
SB16501 – \$10.95

S. Block Magnets. ¼" x ¾".
SB16503 – \$4.65

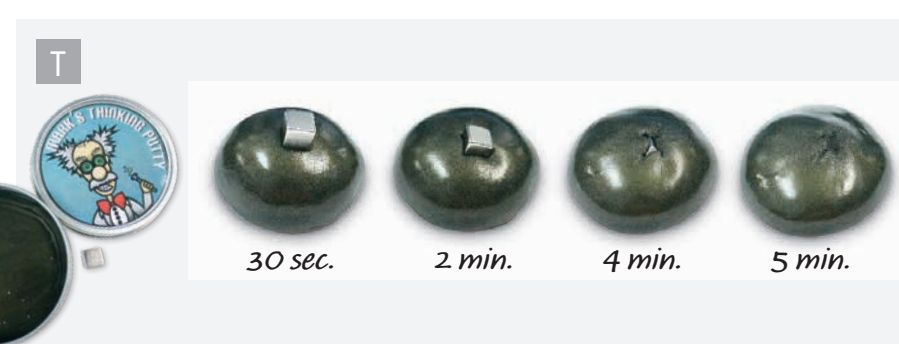

T. Magnetic Putty
Moldable putty takes on properties of a magnet when placed in close contact with included magnet. Made with micron-sized iron-based particles distributed throughout. Teacher's guide included. **CHOKING HAZARD (I)**. Not for under 3 yrs.
SB50318 – \$11.75

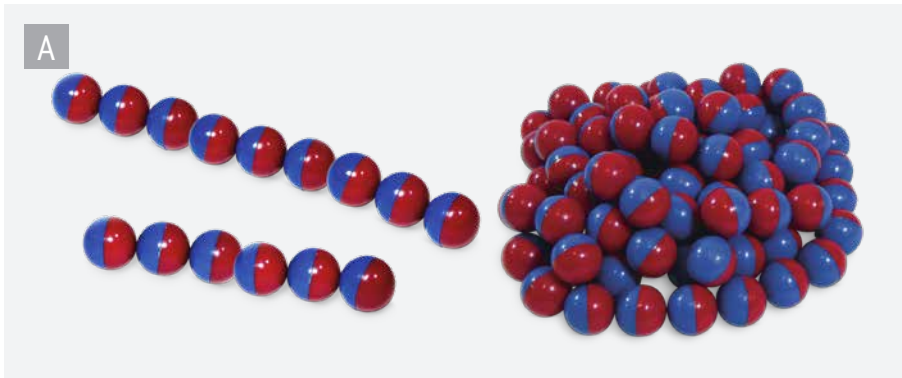

DISCOVER THE POWER of magnets in motion

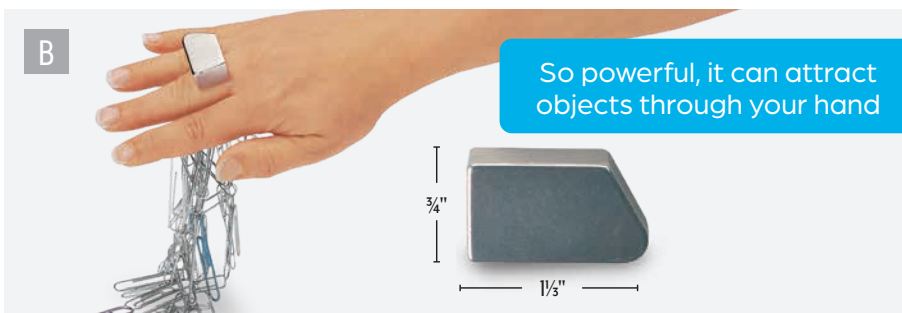

A. North/South Magnet Marbles
Color-coding helps show how magnetic attraction and repulsion cause motion. 5/8" dia. each.
SB52998 Set of 100 — \$34.99

B. Neodymium Magnet
Super-strong magnet, made of the most powerful magnet material in the world, can actually attract through your hand. 1/2" thick x 3/4" x 1 1/3".
SB31326 — \$23.95



C. Mysterious Magnet Tube
Explore 3-D patterns created by magnetic fields. Steel filings are sealed in a container. Includes alnico cow magnet and activity booklet.
SB52997 — \$24.99

D. Iron Filings Set
Set of 5 plastic cases (3" x 2") with enclosed iron filings. Works best with alnico or neodymium magnet (not included).
SB46840 — \$12.75



E. Coarse Iron Filings
Shaker dispenses filings without waste. 1 lb.
S06119 — \$6.95

F. Fine Iron Filings
1.2-oz. tube.
SB50151 — \$4.95



G. Iron Filings
Get 3 different results in magnetism experiments. Includes one 12 oz. jar of each: fine, medium, and coarse.
SB53391 — \$14.99

H. Alnico Magnet Set
Includes 2 bar magnets (3 1/8" x 9/16" x 3/8"), small horseshoe magnet (5/16" W x 1" H), and large horseshoe magnet (9/16" W x 1 3/8" H).
SB44472 — \$42.95

BEST SELLER

Materials for 5 students or 5 groups

Dowling Classroom Attractions Magnet Sets
Provides all needed tools for an effective and creative magnetism unit. For 5 students.

Level 1 Magnet Set. 10 magnet wands, button magnets, magnet marbles, ring magnets, magnetic counting chips, colorful paper clips, and pencils. **CHOKING HAZARD (1, 6).** Not for under 3 yrs.
SB32808 — \$89.99

Level 2 Magnet Set. 5 magnet wands, ring magnets, north/south bar magnets, domino-shaped magnets, ceramic horseshoes magnets, compasses, polished steel shapes, and pencils. **CHOKING HAZARD (1).** Not for under 3 yrs.
SB29805 — \$84.99

Level 3 Magnet Set. 5 alnico bar and 5 alnico horseshoe magnets, 10 ceramic block magnets, 15 latch magnets, 10 disc magnets, 5 lodestones, 5 flexible magnets, 5 pieces of magnetic viewing film, 5 sets of iron filings, 5 compasses, 5 corks, 5 dowels, 5 nails, and demo bar magnet. **CHOKING HAZARD (1).** Not for under 3 yrs.
SB32810 — \$129.99

Magnetic Wand Classroom Pack. Pack of 12 ceramic magnetic wands (2 each of 6 colors).
SB16505 — \$25.99

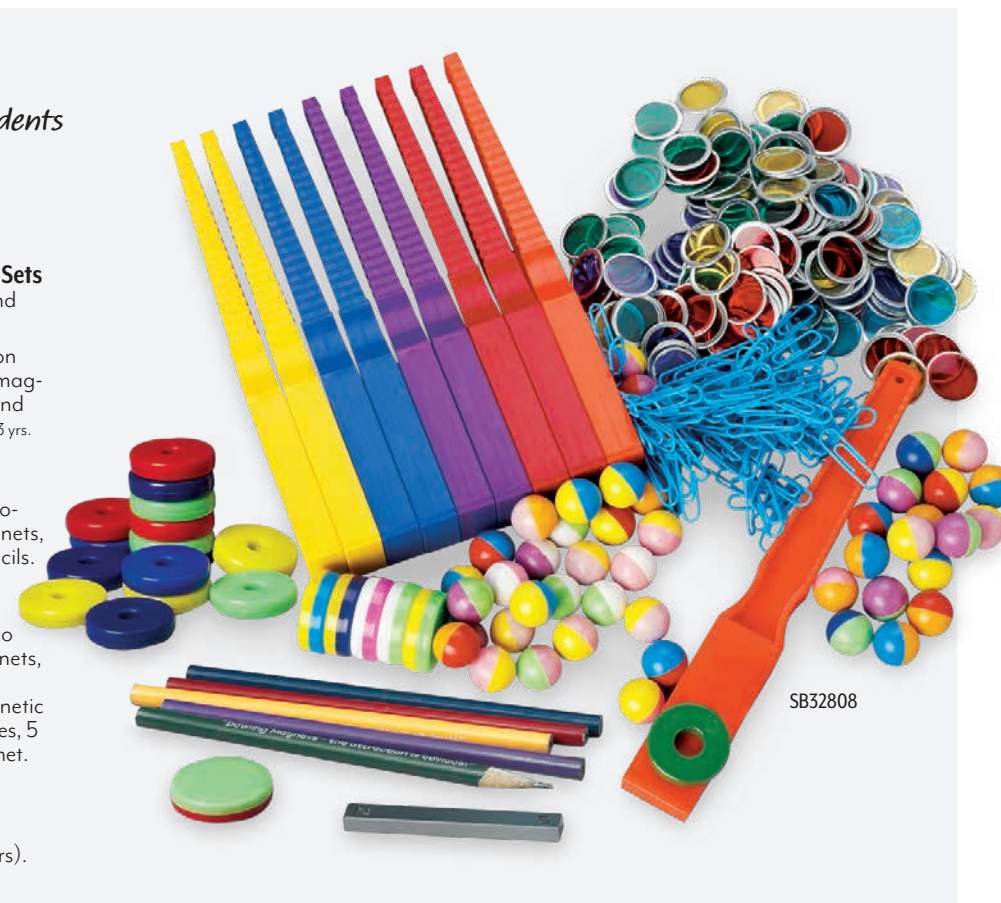

Magnet Levitation Kit
Experiment with equilibrium, gravity, and magnetic fields while building a levitating train. Builds 5 magnetism experiments and 5 magnet levitation projects. Aligned with NGSS.
SB52994 — \$39.99



Magnetic Field Demonstration Plate
Transparent plate is comprised of a matrix of small circular chambers. Each chamber contains an iron rod and functions independently as a plotting compass. 9 13/16" x 9 13/16".
SB48222 — \$36.95



Magnetic Field Demonstrator
Transparent acrylic case holds iron filings in a fluid of proper viscosity. Place an alnico or neodymium magnet on the device, and the iron filings will move to form a pattern that shows the magnetic field of that magnet. 8 1/2" x 4 1/2" x 3/8".
SB30028 — \$15.75

Keep exploring at nascoeducation.com

STEM

Many of the world's future careers will be based around STEM concepts. Prepare students now with engaging kits, games, and activities that cultivate 21st century skills. You'll create a true hands-on learning experience that will help students explore, discover, and soar!

**Matatalab Hands-On Coding**

Gr. PreK-4 Screenless, words-free robot helps students learn how to code. Image recognition technology allows the command tower to recognize tangible coding blocks in front of the device and execute the program. ⚠ CHOKING HAZARD (I). Not for under 3 yrs.

Classroom Set. Includes Coding Set, Musician Add-On, Artist Add-On, and 4 curriculum guides.

EL16879 – \$1,499.00

Coding Set Plus Add-Ons. Includes Coding Set, Musician Add-On, and Artist Add-On.
EL16832 – \$239.00

Coding Set. Includes robot car, command tower, control board, 37 coding blocks, 8 obstacles, 3 flags, 3 challenge booklets, and nature map.
EL16528 – \$169.00

**Code & Go™ Robot Mouse Classroom Set**

Gr. PreK-4 Comes with everything students need to help them master hands-on coding skills. ⚠ CHOKING HAZARD (I). Not for under 3 yrs.

EL16381 – \$215.00

Robot Mouse Set. 16 pieces to create a 20" x 20" maze board.
EL13708 – \$59.95

DEVELOP A STRONG FOUNDATION

with coding concepts students can build on

**Thames & Kosmos Gravity Bugs™ Free-Climbing MicroBot**

Gr. 3-9 Build a mighty robotic bug that defies gravity to crawl up, down, and all around windows. This hands-on construction kit shows students the power of air pressure and brings engineering and physics to life. Includes 78 pieces and an 8-page guide. Requires 1 "AAA" battery. ⚠ CHOKING HAZARD (I). Not for under 3 yrs.
NE30275 – \$24.95

NEW

**Thames and Kosmos® Hero: Sound Sensing Robot**

Gr. 5-8 Hero can locate students, follow them around, be remotely controlled by sound commands, and even play tug-of-war — all by sensing sounds. Includes movable arms that can disappear into his body and an illuminated eye for making facial expressions. 52-page manual.
NE30504 – \$64.95

**Thames & Kosmos Huey: The Line-Tracking, Color-Sensing Robot**

Gr. K-4 Start students off on their coding journey with Huey, a fun, color-sensing robot pal. This kit offers a hands-on, screen-free introduction to the world of robotics and coding. Includes 115 pieces, instruction manual, and challenge book. Requires 3 "AAA" batteries. No computer, tablet, or smartphone needed to operate. ⚠ CHOKING HAZARD (I). Not for under 3 yrs.
NE30278 – \$59.95

Botley™ the Coding Robot

Gr. K+ Introduce coding fundamentals without the need for a screen. Pairs hands-on coding challenges with advanced collision detection, looping commands, and If/Then programming logic. Program up to 80 steps, or turn on black-line-following mode and draw a path for the robot to travel. No smartphone or tablet required. Features object detection sensor, enhanced wheels for multi-surface use, robo-gear for moving blocks and objects, and LEDs to show direction of each step. Includes remote programmer for easy coding input. 77-piece set includes programmable robot, mats, interactive obstacles, blocks, and more. ⚠ CHOKING HAZARD (I). Not for under 3 yrs.
EL16206 – \$74.95



Coding & Robotics	258-269
Circuitry	270-277
Supplemental Curriculum	278-279
Engineering	280-291
Makerspace	292-295

**BEST
SELLER**



EXCLUDED
FROM
DISCOUNTS

Wonder Workshop Dash Robot

Gr. K-6 Bring to life the creativity and critical thinking of coding. Dash is a responsive, Bluetooth-enabled robot that connects quickly and easily to Apple iOS, Android, and Kindle mobile devices. Multiple built-in motors, sensors, LEDs, and audio capabilities allow Dash to interact with students, the environment, and other Dash robots. Program Dash to react to the sound of a clap, perform a victory dance, detect and avoid obstacles, and more. Apps for every age group, learning style, and play pattern are available to introduce students to programming. More coding elements are added as students gain more experience and familiarity. See device requirements below.
ELI3675 – \$179.99



EXCLUDED
FROM
DISCOUNTS

Wonder Workshop Sketch Kit

Attach to Dash or Cue to draw geometric shapes, patterns, words, and more. Includes marker attachment, 6 custom dry-erase markers (1 each of red, blue, green, orange, purple, and black), and 6 project cards. **CHOKING HAZARD (1).** Not for under 3 yrs.
ELI6386 – \$39.99



EXCLUDED
FROM
DISCOUNTS

Wonder Workshop Dash Robot Launcher

Gr. K-6 Transform your Dash robot into a projectile-launching machine! Includes launcher, 3 projectiles, and 6 stacking targets. **CHOKING HAZARD (1).** Not for under 3 yrs.
ELI3759 – \$29.99

Gripper Building Kit for Dash and Cue Robots
Gr. 2+ Expand Dash and Cue robots' capabilities with this easy-to-construct set of functioning arms. Simulate real-world object detection and manipulation using robots' sensors and motors through code or manual remote control. Arms lift, carry, pull, pick up, and place a variety of lightweight objects. Includes 76-piece construction set, 3 building brick connectors, plastic ball, foam number cube, Building Instruction booklet, Quick Start/Solution Guide, and 8 double-sided activity cards (4 for Dash™ and 4 for Cue™). **CHOKING HAZARD (1).** Not for under 3 yrs.
ELI6609 – \$39.99



EXCLUDED
FROM
DISCOUNTS

Device compatibility: Apple iPad or iPhone with iOS 11+; Android phone or tablet with Android 6+ and Bluetooth LE; Kindle Fire 2015 and newer; Chrome Browser on Mac, PC, or Chromebook with Bluetooth LE.



Botley™ the Coding Robot found on p. 259

Beginning Coding Kit

Gr. PreK-3 There are so many screen-free ways to introduce coding concepts to students and this convenient bundle has them all! You'll get a 64-qt. clear storage tote to hold the following five coding activity sets (details for each below):

- 1 Botley the Coding Robot Activity Set (p. 259)
- 3 Coding Critters Play Sets (Ranger and Zip, Scamper and Sneaker, and Rumble and Bumble),
- 1 Let's Go Code! Activity Set

CHOKING HAZARD (1, 4). Not for under 3 yrs.
NE30326 – \$274.95

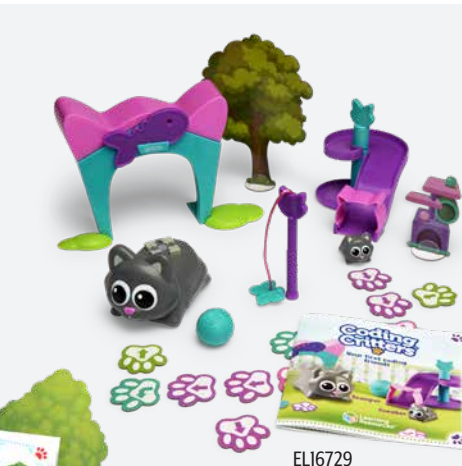

ELI6729



ELI6730



ELI6728

Coding Critters Play Sets

Gr. PreK+ Interactive coding friends introduce preschoolers to critical thinking, problem solving, and other STEAM skills with the help of fun play sets, 20-page storybook with coding adventures, 2 lively characters, and 2 interactive modes filled with sound, motion, and music. 15 pieces each. **CHOKING HAZARD (1, 4).** Not for under 3 yrs.
ELI6728 Ranger and Zip **ELI6729** Scamper and Sneaker **ELI6730** Rumble and Bumble
Each – \$42.95



Let's Go Code!™ Activity Set

Gr. K+ Includes 20 foam maze mats (9½" x 9½"), 20 double-sided coding cards, 10 die-cut pieces, and guide. **CHOKING HAZARD (1).** Not for under 3 yrs.
ELI5376 – \$39.95

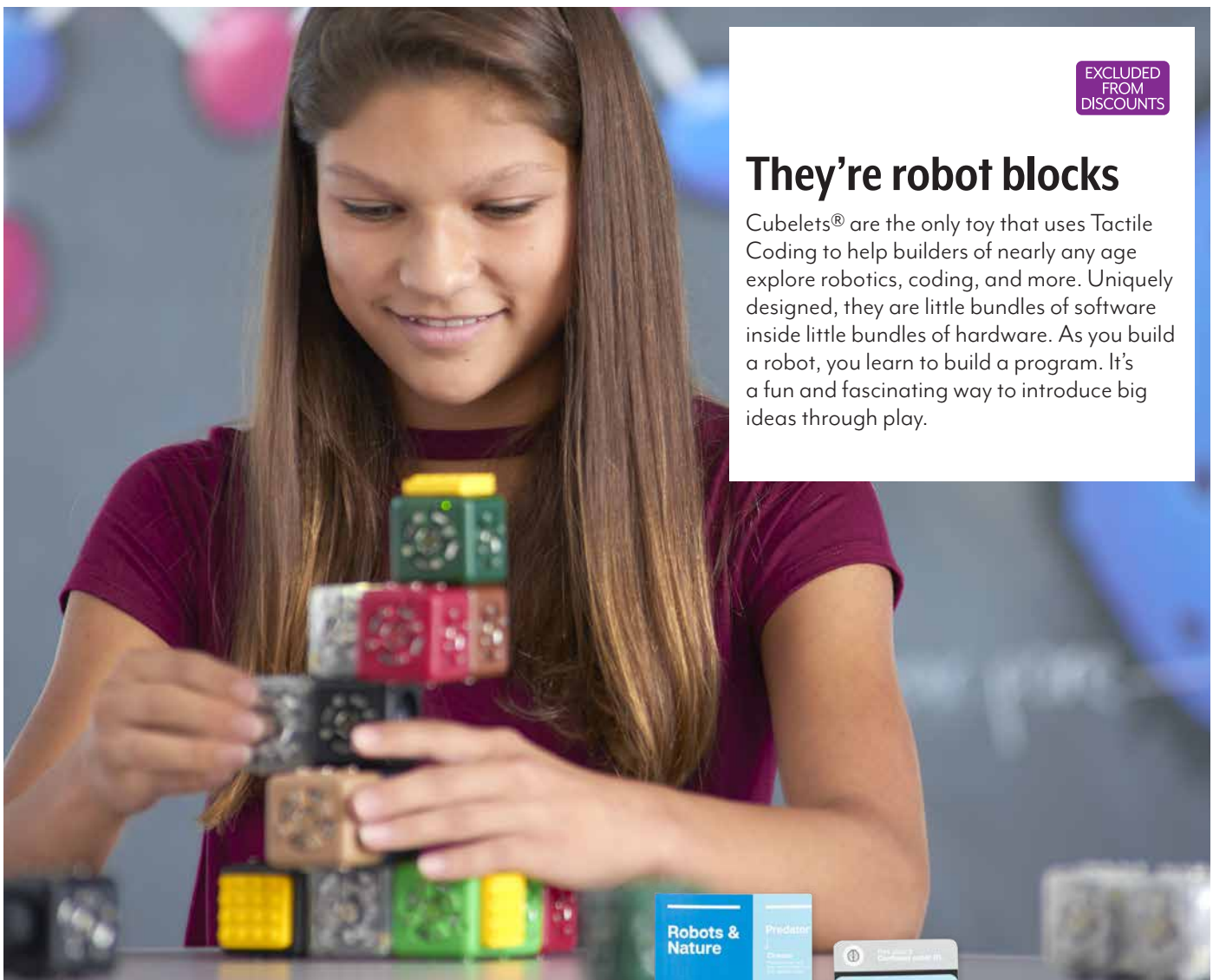

EXCLUDED FROM DISCOUNTS

They're robot blocks

Cubelets® are the only toy that uses Tactile Coding to help builders of nearly any age explore robotics, coding, and more. Uniquely designed, they are little bundles of software inside little bundles of hardware. As you build a robot, you learn to build a program. It's a fun and fascinating way to introduce big ideas through play.

Cubelets®
Introduce robotics, coding, and design thinking as they create simple, mobile, and reactive robots by combining sense, action, and think blocks. Blocks automatically route power and data where needed.

Cubelets® Motivated Makers Pack. Includes 52 cubes, 24 brick adapters, 5-port charger, 5 charging cables, and 1 storage tub. For 6 groups.
SB52239 — \$2,029.00

Cubelets® Boundless Builder Pack. Includes 19 Cubelets®, 4 brick adapters, charging cable, and storage tub.
SB53142 — \$699.00

Cubelets® Classroom Bundles. Includes Lessons & Resources book with standards-aligned lessons, best practices, classroom management tips, and blackline masters. Also includes Cubelets® activity card set, sheet of Cubelets® magnets, and 18" x 24" poster.
SB53304 Gr. 1-3
SB53305 Gr. 4-6
SB53306 Gr. 7-12
Each — \$199.00

Cubelets® Clever Constructors Pack. The most popular size and configuration for classroom educators. Supports 6 groups of 3-5 students each (up to 30 students). Includes 78 Cubelets; 12 Brick Adapters; charger and charging cables; padded storage container; and access to free standards-aligned lesson plans, printable activity cards, online PD, and more. 
NE30480 — \$2,899.00



SB53304

Cubelets® Intrepid Inventors Pack. Perfect for makerspaces, libraries, or classrooms. Supports 6 or 12 groups of 3-5 students each (up to 30 students). Includes 156 Cubelets; 48 Brick Adapters; chargers and charging cables; 2 padded storage containers; and access to free standards-aligned lesson plans, printable activity cards, online PD, and more. 
NE30481 — \$5,779.00

BEST SELLER

Edison V3 Robot

Gr. PreK-12 Programmable robot designed to be a complete STEM teaching resource for coding and robotics education. Durable, no loose parts to manage, rechargeable, compact, and easy to store. Works right out of the box, fully pre-built with all sensors ready to use. No software to install or manage, making it easy to use Edison with different devices and platforms, including laptops, Chromebooks, and tablets. Edison lessons and teacher guides are free to download. Each Edison V3 robot comes with an internal rechargeable battery and attached USB cable for programming and charging. Charge up to 5 robots at once with the optional EdCharger.  CHOKING HAZARD (1). Not for under 3 yrs.

NE30497 Single Robot — \$55.00

*NE30498 10 Robots — \$419.00

*NE30499 EdCharger — \$39.00

*EXCLUDED FROM DISCOUNTS



NEW



EXCLUDED FROM DISCOUNTS

Makeblock mBot

Gr. 6+ Hands-on experience in programming, electronics, and robotics. Block-based programming software enables students to drag and drop command blocks to control their mBot. Students can use 3 preset controls or write new code through the mBlock app. Connects to smartphones, tablets, and computers via Bluetooth®. Compatible with other Makeblock platforms and LEGO® blocks. Add-on packs require an mBot (not included).

mBot Ranger Robot Kit. Students can use 3 preset forms or build their own robotic designs. 10 extension interfaces, 12 electronic modules, and 6 sensors.  CHOKING HAZARD (1). Not for under 3 yrs.
NA10356 — \$205.00

mBot-S Explorer Kit. Includes mBot and LED matrix.

 CHOKING HAZARD (1). Not for under 3 yrs.

NA10350 — \$90.00

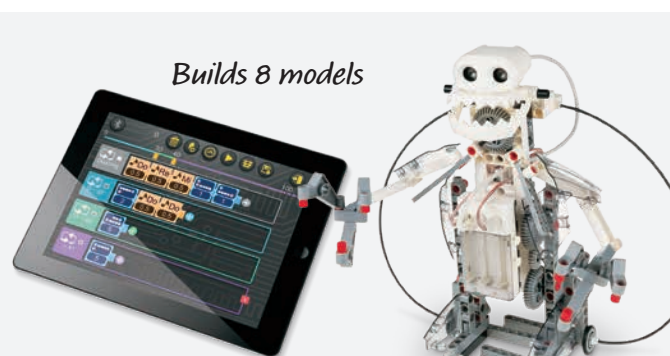

Robotics: Smart Machines

Gr. 5+ Code programs using an easy, visual programming app on a tablet or smartphone. Requires a tablet or smartphone running iOS® or Android™. iOS® devices must support Bluetooth® 4.0 and must be running iOS® 8.0 or later. Android™ devices must support Bluetooth® 4.0 and be running Android™ 4.4 or later.
EL14864 — \$134.95

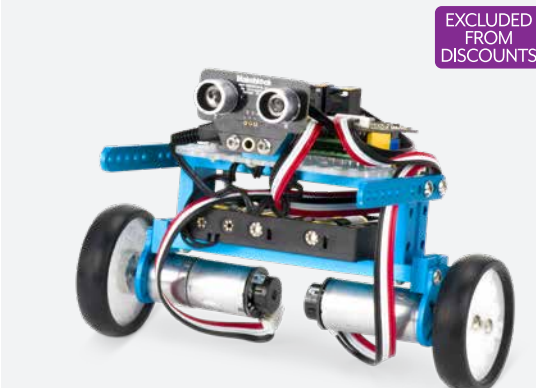

EXCLUDED FROM DISCOUNTS

Makeblock Ultimate 2.0 10-in-1 Robot

Gr. 6+ Learn about mechanical design, electronics, and programming. Block-based programming software enables students to drag and drop function blocks to control their robot. Also supports Arduino IDE, NodeJS, and Python programming languages. Compatible with Arduino and Raspberry Pi. Over 160 mechanical parts and 80 types of electronic modules. Assembly guides for 10 designs serve as springboards for new creations.  CHOKING HAZARD (1). Not for under 3 yrs.
NA10357 — \$400.00

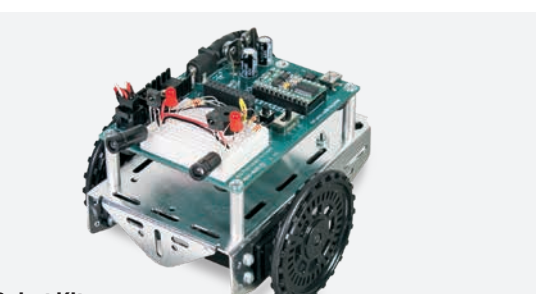

Boe-Bot Robot Kit

Gr. 9+ Build your own rolling robot with a BASIC Stamp 2 microcontroller brain. No programming experience needed. Assembles in 1-2 hours. Allows you to learn and create your own electronic circuits; solder-free connections; easy-to-learn PBASIC programming language; touch, light, and infrared sensors that let the bot navigate on its own; and LEDs and a piezo speaker for audio and visual feedback. Mounting holes for servos and accessories. 13" x 9½" x 3½". Requires 4 "AA" batteries (not included).
SB51418 — \$249.95

Ozobots – Tiny robots, big learning

These award-winning robots engage students of all ages. Introduce them to coding with screen-free color-coded programming and then graduate to simple block programming with color-coded apps. Free online curriculum offers limitless cross-curricular projects and extensions.

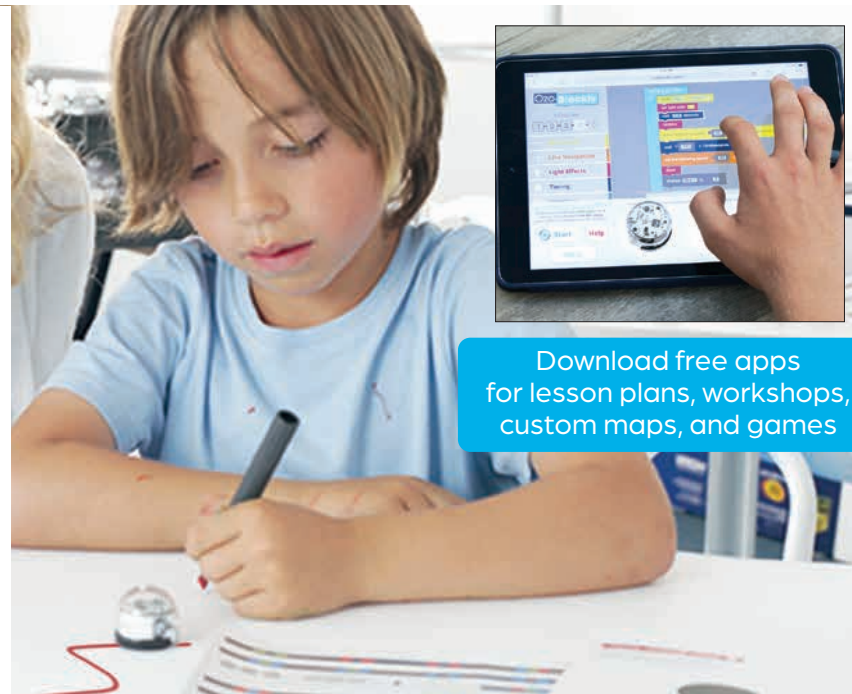

Download free apps for lesson plans, workshops, custom maps, and games



Ozobot Evo Robot Classroom Kits

Gr. K+ Students can code Evo two different ways: screen-free with Color Code markers and online with OzoBlockly visual programming. Features including proximity sensors, expressive sounds, LED lights, and Bluetooth® LE. Kits include Ozobot Evo robots, marker sets, a charging and storage base, a storage bin, and an instructional poster. You'll also get an Ozobot Classroom license code for access to teacher training, hundreds of STEAM lessons, and real-time information about your students' online and offline activity. **CHOKING HAZARD (1).** Not for under 3 yrs.

NA10449 12 Pack – \$2,050.00

NA10450 18 Pack – \$2,990.00

Washable Markers for Evo and Bit

Use to draw paths for Ozobot to traverse, control its behavior, and make it do cool moves. Includes 1 blue, 1 green, 1 red, and 2 black markers. Washable and nontoxic.

NE30369 – \$8.00



Ozobot Crawler

Gr. 3+ Set includes 6 ready-to-assemble kits that build into bug-like devices in which Evo sits. Students are challenged to engage in the mechanical processes that are created between Evo and its new legs using Ozobot Blockly programs or Evo App drive control. Ozobot Evo required (sold separately). **CHOKING HAZARD (1).** Not for under 3 yrs.

NE30494 – \$30.00

Ozobot Evo Educator Entry Kit

Gr. K+ Pocket-sized robot can see colors, follow lines and mazes, detect intersections on paper and screens and be programmed to move. Scalable platform supports simple to complete coding. Lessons teach how to code online with OzoBlockly and screen-free with Color Codes. Includes Ozobot Evo robot, 4 Color Code markers, Get Started Activities protective case, and charging cable. **CHOKING HAZARD (1).** Not for under 3 yrs.

NE30106 – \$175.00



DISCOVER NEW OZOBOT STEAM KITS

Ready-to-go NGSS-aligned activities encourage problem-solving, critical thinking, and collaboration through real-world applications



Ozobot STEAM Kit: OzoGoes to the Solar System

Gr. 3+ Explore the wonders of the solar system! Designed to supplement classroom learning, this ready-to-go kit engages an individual learner or a group of up to 4 students in a hands-on project. Included NGSS-aligned activities support learning with and without an Ozobot Evo robot (not included).

NE30370 – \$40.00



Ozobot STEAM Kit: OzoGoes to the Sun, Earth & Moon

Gr. 3+ Learn how the sun and moon affect phenomena on Earth. Designed to supplement classroom learning, this ready-to-go kit engages an individual learner or a group of up to 4 students in a hands-on project. Included NGSS-aligned activities support learning with and without an Ozobot Evo robot (not included).

NE30371 – \$30.00

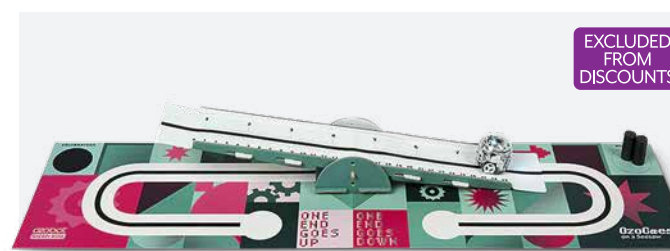

Ozobot STEAM Kit: OzoGoes on a Seesaw

Gr. 3+ Teach students about leverage and simple machines. Designed to supplement classroom learning, this ready-to-go kit engages an individual learner or a group of up to 4 students in a hands-on project. Included NGSS-aligned activities support learning with and without an Ozobot Evo robot (not included).

NE30373 – \$30.00



Ozobot® Color Code Magnets: Base Kit

PreK+ Includes 36 puzzle pieces that pair with the Evo robot. Easy-to-manipulate magnets are perfect for learning the foundational concepts of coding and experimenting with sequencing, logic, and problem-solving. **Note:** This product does not include an Evo robot. **CHOKING HAZARD (1).** Not for under 3 yrs.

NE30566 – \$30.00

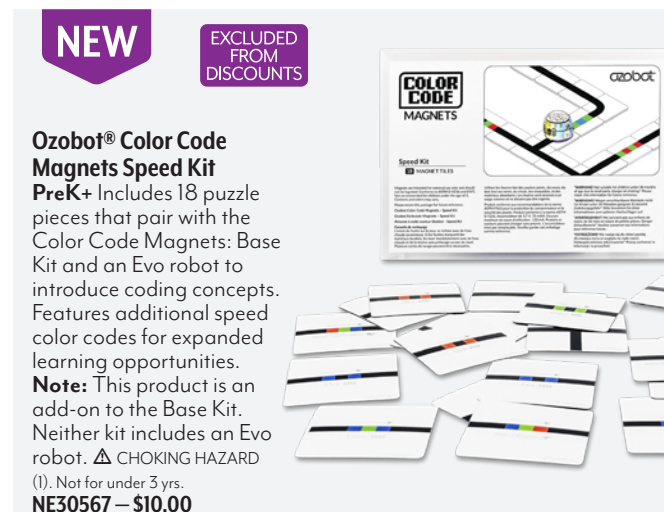

Ozobot® Color Code Magnets Speed Kit

PreK+ Includes 18 puzzle pieces that pair with the Color Code Magnets: Base Kit and an Evo robot to introduce coding concepts. Features additional speed color codes for expanded learning opportunities. **Note:** This product is an add-on to the Base Kit. Neither kit includes an Evo robot. **CHOKING HAZARD (1).** Not for under 3 yrs.

NE30567 – \$10.00



Ozobot® Color Code Magnets: Special Moves Kit

PreK+ Includes 18 puzzle pieces that pair with the Color Code Magnets: Base Kit and an Evo robot to introduce coding. Features additional special moves color codes for expanded learning opportunities. **Note:** This product is an add-on to the Base Kit. Neither kit includes an Evo robot. **CHOKING HAZARD (1).** Not for under 3 yrs.

NE30568 – \$10.00

CRACK THE CODE

with robots students can learn to program and control



Thames & Kosmos® KAI: The Artificial Intelligence Robot
Gr. 5+ Build and program an intelligent, six-legged, app-enabled robot that “learns” from your physical gestures and sounds. KAI can also be controlled remotely through the app and show different expressions and scrolling messages. Full-color, 64-page manual provides step-by-step illustrated assembly and programming instructions and teaches lessons in AI and robotics. App requires iOS or Android device.
NE30399 – \$99.95



Thames & Kosmos Robotics: Smart Machines – Sidekick
Gr. 3–9 Give students an amazing robotic buddy to build and control. Sidekick has two modes: 4-wheeled rover or 2-wheeled robot. It can be programmed from a built-in keypad or included app. Includes 129 pieces and 36-page guide. Requires 4 “AA” batteries. Tablet or smartphone required to use Sidekick app (available for iOS and Android). Not for sale in Canada. **NE30283 – \$69.95**



Thames & Kosmos Robotics: Smart Machines – Tracks & Treads
Gr. 3–9 Students will have everything needed to build 8 robots that use continuous tracks, also known as tank treads, to move. In addition to constructing the models, they’ll learn how to use the included visual programming app to code. Includes 197 pieces and 60-page guide. Models require 3 “AA” batteries. Tablet and smartphone required to use programming app (available for iOS and Android). **NE30280 – \$139.95**



JD Humanoid
Gr. 6–12 A fully functional humanoid robot kit featuring 16° of freedom and metal gear servo motors, meaning it has 16 motorized joints for walking, dancing, or anything you teach it. Eyes contain 18 RGB LEDs (9 per eye) that can be easily programmed and animated for unlimited expressions of up to 1 million colors. Compact grippers powered by strong, metal-gear servo motors for interacting with soft, light objects. A camera is contained in the robot’s head.
SB52298 – \$599.99

NEW



Teach Tech™ Mech-5 Mechanical Coding Robot
Gr. 4–8 This build-it-yourself robot offers innovative screenless coding. Just snap coding buttons onto the mechanical coding wheel and place it into the robot to initiate movements such as forward, backward, turn, or pause. 220+ parts. Requires 2 AAA batteries (not included). **NE30490 – \$45.95**

NEW



Teach Tech™ SolarBot.14
Gr. 4–8 Construct 14 different solar-powered robots that operate on land and water. After assembling a model, students can easily reassemble the components into different models. 250+ parts. No batteries required. **NE30491 – \$38.95**

NEW

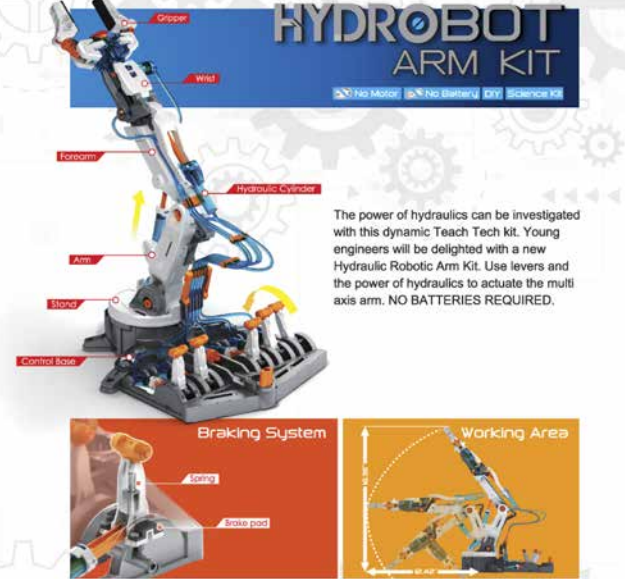

Teach Tech™ HydroBot Arm Kit
Gr. 7+ Use levers and the power of hydraulics to command the multi-axis robotic arm to move, grip, and lift items up to 50 grams. Clear, graphic instructions make assembly and operation easy. Includes over 230 parts. No batteries required. **NE30492 – \$65.95**

NEW



Teach Tech™ Zivko the Robot
Gr. 4+ This intelligent hexiped robot is ready to introduce students to artificial intelligence (AI) technology. Zivko has two function modes: Follow or Explore. Includes over 100 parts. Requires 4 AAA batteries (sold separately). **NE30493 – \$53.95**



EXCLUDED FROM DISCOUNTS

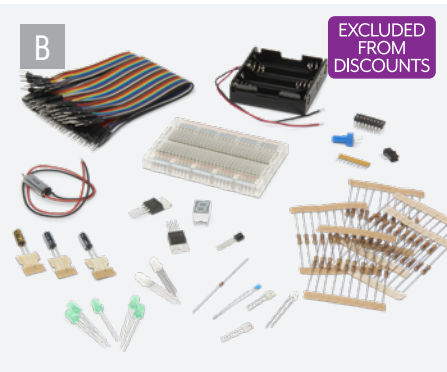

EXCLUDED FROM DISCOUNTS



EXCLUDED FROM DISCOUNTS

Enable students to learn basic coding and design using TI graphing calculators

A. TI-Innovator™ Hub Kit
Extends the functionality of Texas Instruments® graphing calculators to enable students to learn basic coding and design. Supports TI-84 Plus CE graphing calculator. Built-in TI LaunchPad™ Technology gives students exposure to professional applications. Write code to program working solutions that actuate in-built LEDs, sensor, and speaker.
NA10315 – \$80.50

B. Breadboard Pack. For exploring electronics principles. Components for the Path to STEM Projects activities.
NA10317 – \$42.50

C. Rover. Robotic vehicle with multiple built-in sensors. Compatible with graphing calculators.
NA10326 – \$166.95

Snap Circuits®
Snap Circuits make learning electronics easy, fun, and safe. Just follow the colorful pictures in the manual and build exciting projects such as radios, digital voice recorders, alarms, doorbells, and more. All parts are mounted on plastic modules and snap together with ease. No tools required. ⚠️ CHOKING HAZARD (I). Not for under 3 yrs.



EXCLUDED FROM DISCOUNTS

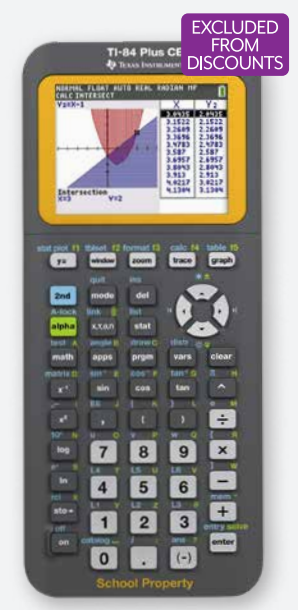

EXCLUDED FROM DISCOUNTS

TI-84 CE Graphing Calculator
Give students the power of portable programming for math class and other applications. This lightweight and durable calculator features a color screen, an easy-to-read display, and a rechargeable battery. It has eight different graph styles and can save up to 10 graphing functions. Real and complex numbers can be calculated to 14-digit accuracy and displayed with 10 digits plus a two-digit exponent. USB cable and protective case included.
NE30224 – \$175.00

TI-84 Plus CE EZ Spot Teacher Pack. 10 EZ Spot units and rechargeable batteries, 5 USB cables, 5 unit-to-unit cables, TI charging station CE, and poster.
NA10409 – \$1,805.05

Robotics Workshop
Gr. 4–6 Use sensors, motors, a core controller, and hundreds of snap-together pieces to construct 12 different robots. Control creations wirelessly with an app on tablets and smartphones. Includes 96-page manual.
EL14873 – \$249.95

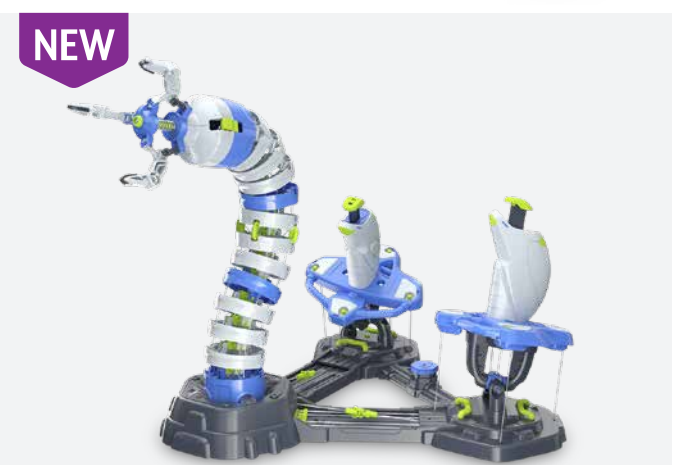
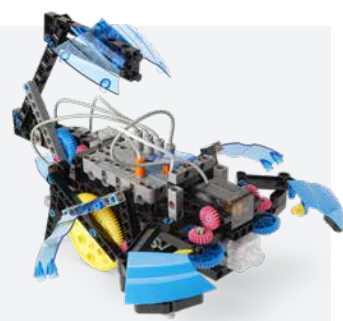

Thames and Kosmos® Bionic Robotic Arm
Gr. 5–12 Assemble this segmented arm from almost 300 pieces to learn about biomimicry. The innovative system is controlled by joysticks that pull and release nylon cables, enabling precise movements. 56-page manual guides experimentation and provides scientific information about how robotic arms work, as well as real-world examples.
NE30503 – \$54.95

Snap Circuits® MyHome Kit
Gr. 3+ Students can build a house with real functional 3D circuits, just like the ones they use every day, and learn all about how they work. Includes 60 pieces and an illustrated, full-color manual with 25+ projects.
NE30431 – \$79.95



Snap Circuits® Discover Coding Kit
Gr. 3+ Build projects with lights, sounds, and a motor and control them with a smartphone or tablet. Includes over 30 pieces, Bluetooth-powered SC Controller, 5 control outputs, and an illustrated, full-color manual.
NE30432 – \$94.95



Snap Circuits® STEM Kit
Gr. 3+ Dive into STEM concepts with award-winning Snap Circuits! Projects explore magnetic fields, how the electricity in a home works, how switches control electricity, and more. Includes over 45 pieces and an illustrated, full-color manual with 85+ projects.
NE30434 – \$58.95



Snap Circuits® STEM Classroom Activity Kit
Gr. 3–5 Get an entire circuitry unit in one convenient kit — created by teachers for teachers! The step-by-step curriculum walks through 10 days of open-ended activities. Includes 6 activity kits (support up to 18 students), 1 teacher's guide, 6 student workbooks (additional workbooks sold separately), detailed parts list and explanation, spare parts, traditional (pre/post/summative) and project-based assessments, presentation materials, summary sheet, and carrying case.
NE30435 – \$475.00



**BEST
SELLER**



Paper Circuits Classroom Kit
Make LED art and science projects using conductive foil tape. No wires needed.
SB51143 – \$110.00
Individual Student Kit
NE30039 – \$10.95

Individual Student Large Circuitry Kit
Gr. 3–12 Three weeks of projects and lessons that work either in the classroom or can be sent home for virtual learning. Each kit contains enough materials to create a Bristlebot, Solar Bug (NE30035), LED name badge (NA10419), and several paper circuit projects with additional batteries, roll of Maker Tape™, LEDs, binder clips, self-sticking motor, and online directions in English and Spanish.
NE30040 – \$30.95



Brown Dog Gadgets LED Paper Name Tag Classroom Set
Gr. 4+ Young makers will love the feeling of accomplishment they get when they create their own colorful light-up “Hello My Name Is” name tag in 10–15 minutes. Includes materials for making 50 name tags.
NE30513 – \$70.00



Origami Circuit STEM/STEAM Project Kits
Gr. 3–12 Combine the ancient Japanese paper art of origami with the creation of simple electronic circuits to create a hands-on STEM/STEAM lesson. Final projects will move, light up, and blink, combining art design, engineering and basic electronics. Choose from a set of 4 (for individual student or pod learning situations) or 25 (for a whole classroom). Build uses solderless, flexible, durable and conductive pathways with nylon-based Maker Tape™. Kits include origami paper, blinking LEDs, colored LEDs, binder clips, coin batteries, vibrating motors, and Maker Tape™. All final projects are powered at 3V. Directions in English and Spanish and robot template available online.
NE30037 Set of 4 – \$27.00 **NE30038 Set of 25 – \$135.00**



Solar Bug STEM Project Kits
G. 3–12 Help students explore solar energy, motion, and engineering as sunlight directly powers a vibrating motor to scoot critters along. Use as a stand-alone STEM activity or as part of a larger solar energy lesson. Choose from sets of 4 (for individual student or pod learning situations) or 25 (for a whole classroom). Two options for building: Use the included Maker Tape™ to connect the vibrating motor to the solar cell, or use a soldering iron to quickly attach the motor to the solar cell. Hot glue gun and a wire cutter require to complete the 10- to 20-minute project. Online directions in both English and Spanish available.
NE30035 Bug Set of 4 – \$25.95 **NE30036 Bug Set of 25 – \$100.00**



Bristlebot STEM Project Kits
Gr. 3–12 Students will build a small robot using a toothbrush head and googly eyes that will scurry along a flat surface. Adjust the balance and placement of attachable pipe cleaners to change the way they move and behave with an easy-to-add vibrating motor.
NE30031 Set of 4 – \$22.00
SB50347 Set of 10 – \$54.95
NE30032 Set of 25 – \$110.00

Conductive Nylon Tape
Conductive tape that is much stronger and easier to use than copper foil tape.

Product No.	Length	Width	Each
SB52504	65.6' (20 m)	¼"	\$11.95
SB52505	16.4' (5 m)	⅛"	\$5.95

Conductive Thread
Gr. 5+ Pre-wound bobbin gives 16¾' of conductive thread for light-up bracelets, T-shirts, stuffed animals, and more.
SB52859 – \$3.95

Crazy Circuits Coding Kit
Gr. 4+ Explore programming and automation by building and coding with this kit's Arduino-powered Robotics Board and over 20 other sensors and parts, including LEDs, push buttons, a Piezo speaker, and more. Everything is ready to use out of the box — no breadboard or soldering required. Crazy Circuits parts are compatible with LEGO® and other popular brick building systems. Includes instruction cards and access to online curriculums. **CHOKING HAZARD (I).** Not for under 3 yrs.
NE30151 – \$110.00



Crazy Circuits Classroom Sets
Each set includes self-contained project boxes for students, as well as a dedicated teacher supply box. Free online access to curriculum, lesson plans, and student activity packets aligned to state and national standards are included. Each set includes 4 student kits and 1 teacher kit. **CHOKING HAZARD (I).** Not for under 3 yrs.

Crazy Circuits 101. Covers simple circuit design, including switches, diodes, batteries, resistors, transistors, and integrated circuits.
SB53074 – \$650.00
Crazy Circuits Programming 101. Uses Arduino programming to read sensor values (distance, temperature, humidity, light), output data through a display, manipulate sound and light outputs, and drive servos.
SB53078 – \$1,200.00



Crazy Circuits Makerspace Pack
Create STEM and STEAM projects with this electronic learning platform. Students will learn how to add motion and programming actions to projects, circuits, and Arduino sketches. Build new projects or use pre-programmed sketches with the Crazy-Touch and Crazy-Duino boards. Create your own light-up project, programming projects, robotics projects, touch-sensitive synthesizers, and more. This non-soldering pack works well with conductive tapes for paper crafts, conductive threads for e-textile sewing, conductive inks and conductive paints for artwork, alligator clips, and paper clips. Also compatible with most electrical components and brick building systems. Also creates programming projects, robotics projects, and more. Includes 186 parts.
SB52499 – \$1,100.00



Visit nascoeducation.com for full list of components

Crazy Circuits Starter Kit
Gr. 4–12 Create fun STEM and STEAM projects with this electronic learning platform. This non-soldering starter kit works perfectly with conductive tapes for paper crafts, conductive threads for e-textile sewing, conductive inks and paints for artwork, and even alligator clips or paper clips. Compatible with Lego® and other popular brick building systems. Easily add effects, lights, and switches to your next electronics project. Includes 18 parts and a plastic organizer.
SB52497 – \$54.95





E-Blox® Lite Blox Student Set
Gr. PreK+ Give students the blocks for building early learning and motor skills through fun and play. Plug the LED Blox into the included power board and see them light up and change colors. Set includes a battery module, power board, 30 LED Blox, and an online animated curriculum with teacher guides and lesson plans. **CHOKING HAZARD (1).** Not for under 3 yrs.
NE30231 — \$39.99



E-Blox® Sound Activated Dancing Lights Student Set
Gr. K-2 Introduce students to STEM concepts with sound activated building blocks. Includes 32 pieces and an online animated curriculum with teacher guides, lesson plans, quizzes, and quiz answer sheets that cover shapes, building fundamentals, using light to communicate, and more. **CHOKING HAZARD (1).** Not for under 3 yrs.
NE30232 — \$39.99



E-Blox® Flying Saucer Student Set
Gr. 1-3 These LED building blocks contain electronic components such as a battery module, switches, LEDs, and a motor. Contains 10 pieces and an online animated curriculum with teacher guides, lesson plans, quizzes, and quiz answer sheets that cover electricity and circuitry, light, switches, telecommunications, and more. **CHOKING HAZARD (1).** Not for under 3 yrs.
NE30233 — \$24.99



E-Blox® Eco Fidget Lights Student Set
Gr. 1-3 Light up STEM lessons with these colorful building blocks. Contains 7 pieces and an online animated curriculum with teacher guides, lesson plans, quizzes, and quiz answer sheets that cover electricity and circuitry, generators, parallel connections, and more. **CHOKING HAZARD (1).** Not for under 3 yrs.
NE30234 — \$24.99



E-Blox® Fan Launch Light Show Student Set
Gr. 2-4 The colorful building blocks in this set contain 25 pieces and an online animated curriculum with teacher guides, lesson plans, quizzes, and quiz answer sheets. Electricity and circuitry, light, sound, switches, telecommunications, Morse Code, and more are all covered. **CHOKING HAZARD (1).** Not for under 3 yrs.
NE30235 — \$39.99

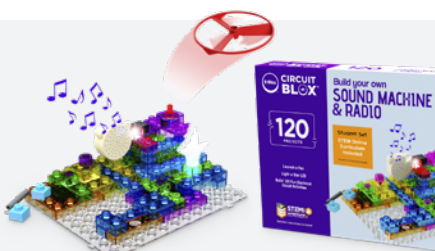

E-Blox® Sound Machine and Radio Student Set
Gr. 3-5 Use these building blocks for STEM lessons. Includes 49 pieces and an online animated curriculum with teacher guides, lesson plans, quizzes, and quiz answer sheets that cover electricity and circuitry, motors and flying saucers, light, sound, switches, telecommunications and FM radio, and more. **CHOKING HAZARD (1).** Not for under 3 yrs.
NE30236 — \$74.99



E-Blox® Building Brick Sets - Circuit Blox™ 800 Classroom Set
Gr. 3+ E-Blox® are not your ordinary building bricks. The built-in technology helps you create electrical circuits with no wires to worry about. The bricks connect to a battery pack allowing budding engineers to bring their creations to life with lights, sounds, or spinning.

Make more than 800 different projects with this engaging kit while learning about electricity, current, and voltage. Lights, sounds, even a motor and fan will help builders design pieces that light up, make noise, move, and more. Set includes various switches, lamps, heart and star LEDs, speakers, audio blocks, buzzers, inductors, windmills, motors, resistors, photoresistors, variable resistors, capacitors, transistors, and more; 312 overall parts; color-changing lamp module, and carrying case. **CHOKING HAZARD (1).** Not for under 3 yrs.
Z52176 — \$519.95



E-Blox® Glowing LED FM Radio Student Set
Gr. 4-6 Cover lessons on electricity and circuitry, motors and flying saucers, light, sound, switches, telecommunications and FM radio, RC circuits, and more with this set of LED blocks. The set contains 66 pieces and an online animated curriculum with teacher guides, lesson plans, quizzes, and quiz answer sheets. **CHOKING HAZARD (1).** Not for under 3 yrs.
NE30237 — \$99.99

BEST SELLER

Makey Makey®
Gr. 3+ Connect device to a USB port in lieu of a keyboard or mouse and use included alligator clips and connector wires to connect everyday objects to the device to turn them into touch pads.
EL13903 — \$60.95
STEM Pack — Invention Literacy Kit. Includes 12 Makey Makey® boards, components, and 12 Makey Makey® optimized conductive 6B pencils. **NZ10370 — \$750.00**

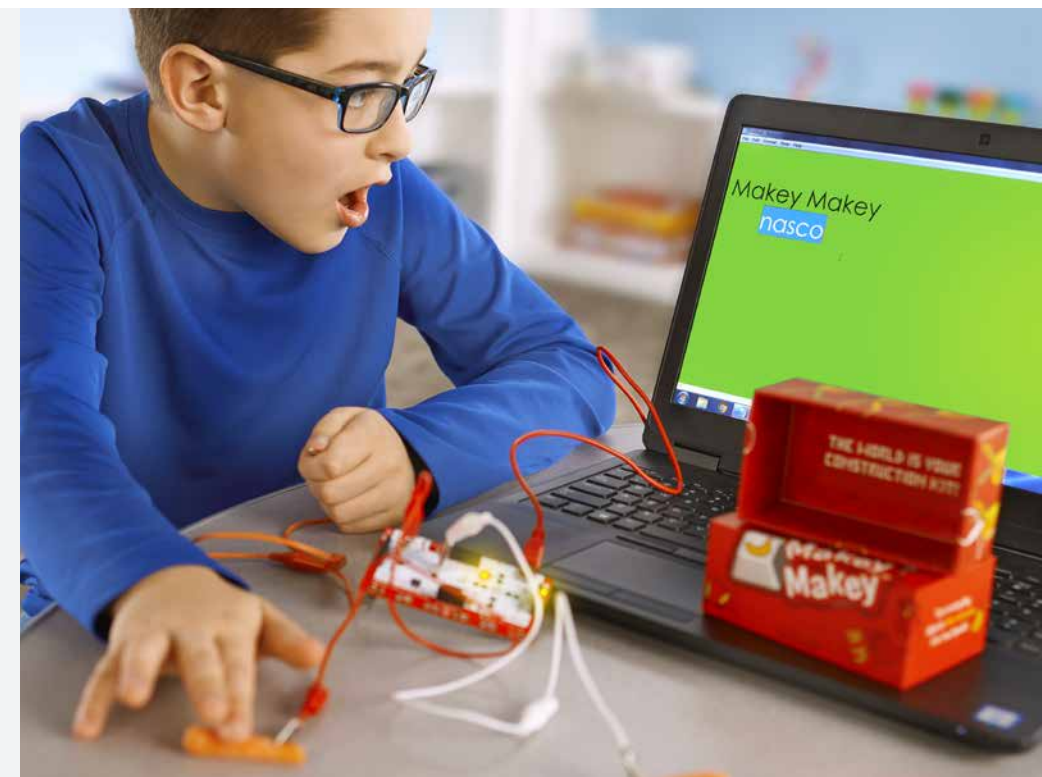

*EXCLUDED FROM DISCOUNTS



Circuit Stickers Educator Packs
For 30 students; 90 stickers and 90' of copper tape.
SB52023 White Circuit Stickers — **\$124.95**
SB53167 Red, Yellow, and Blue Circuit Stickers — **\$124.95**
Starter Kit. 12 stickers and everything needed to get started with circuit stickers.
SB51200 — \$34.95



Pre-Mounted Chibi Chip and Clip
Makes LED stickers blink and fade. Includes chip, clip, and cable.
SB53170 — \$38.95



Copper Tape
16' roll.
SB53173 — \$10.95



LED Circuit Stickers Packs
LED circuits on peel-and-stick stickers — no soldering, plugging wires, or clips required. Learn to build circuits while making interactive artwork. Contains 10 each of red, yellow, and blue LED circuit stickers.
SB53176 — \$34.95



EXCLUDED FROM DISCOUNTS

Strawbees® Robotic Inventions for micro:bit

Gr. 3–9 This add-on kit allows students to snap a micro:bit onto their Strawbees® creations and turn them into robotic, programmable mechanical structures. Kit does not include the micro:bit, USB cable, batteries, or straw connectors. **NE30332 – \$52.50**

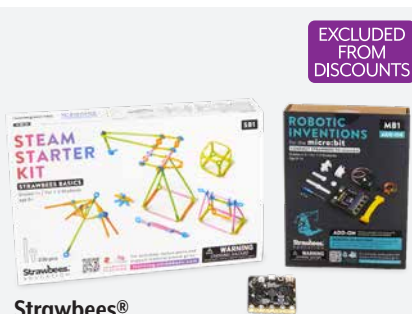

EXCLUDED FROM DISCOUNTS

Strawbees® STEAM Starter Kit With micro:bit

Gr. 3–9 Give students more possibilities when exploring robotics in the classroom. This bundle includes supplies that students can add to their robotics toolbox so they have more capabilities to build, program, and play. Includes Strawbees® STEAM Starter Kit, Robotic Inventions for the micro:bit, and BBC micro:bit. **NE30207 – \$113.00**

NEW



Kitronik ARCADE for micro:bit and MakeCode Arcade

Handheld gaming platform designed to elevate the functionality of your latest BBC micro:bit — just slot in the included edge connector and you're ready to go! Write fun and educational games using the Microsoft MakeCode Arcade game editor. Processing power, game storage, and audio feedback are provided by the micro:bit (not included). Arcade uses 3 AA batteries. Croc-clippable connections for extras. Full color, 1.77" LCD screen. 7 fully programmable buttons. **NE30610 – \$38.00**



Crazy Circuits Bit Board Kits for micro:bit Handheld Computer

Gr. 2–12 Now students can combine the micro:bit computer (SB53386, at right) and building bricks together to create all sorts of amazing projects. The Bit Board snaps onto any building brick-compatible component and students can connect other Crazy Circuits brand components with the included Maker Tape. Use a ribbon cable to connect sensors, or directly plug a servo into the Bit Board. Use the built-in relay to control DC motors and devices.

You and your students will appreciate the graphic way of working and programming with microcontrollers that the micro:bit allows.

Two options available. Choose the **Complete Kit** to get push buttons, speakers, potentiometer, slide switch and more. Or order the **Basic Kit** for board, connector, USB cable, and Maker Tape.

Complete Kit includes:

- Crazy Circuits Bit Board
- Right-angled micro USB cable
- 16" L x 1/8" W roll of Maker Tape
- 2 "AAA" battery holder with JST connector
- 2 Crazy Circuits jumbo push buttons
- 4 Crazy Circuits jumbo LEDs
- Crazy Circuits NeoPixel
- Crazy Circuits Potentiometer
- Crazy Circuits Piezo speaker
- Crazy Circuits slide switch
- LEGO®-compatible servo with connector
- LEGO® base plate
- 5 alligator clips
- Guide cards
- Plastic organizer

NE30101 – \$110.00

Basic Kit includes:

- Crazy Circuits Bit Board
- Right-angled micro USB cable
- 16" L x 1/8" W roll of Maker Tape
- 2 "AAA" battery holder with JST connector

NE30102 – \$30.95

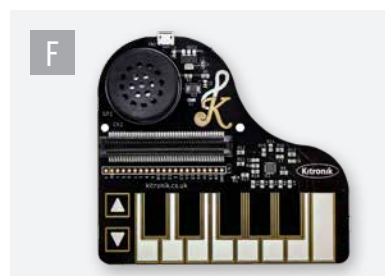
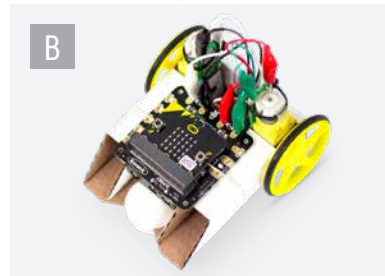

BBC micro:bit

Gr. 2+ A powerful handheld, fully programmable computer. Students write code using one of the easy-to-use editors on microbit.org, connect micro:bit to a computer via USB, then press the compile button in the editor to drop the downloaded file directly onto the device. Features on-board accelerometer and compass sensors, Bluetooth® Low Energy and USB connectivity, 25-LED display, 21 pin edge connector, and 2 programmable buttons. Also has an app for Android™ devices. **NE30213 – \$47.00**

A. BBC micro:bit

Four assorted colors (no color choice).

SB53386 – \$30.00

BBC micro:bit Starter Kit

Contains everything needed to connect BBC micro:bit to a computer and to power it once disconnected from the computer. Includes BBC micro:bit, 39 3/8" USB cable, battery cage, and 2 "AAA" batteries.

SB53378 – \$40.00

B. Simple Robotics Kit for BBC micro:bit

Gr. 6–10 Students will build an entry level, easy build robot that requires no soldering. From its customizable, one-piece cardboard chassis to its clip lead connections, everything goes together easily to build a robot. Kit includes a motor driver for BBC micro:bit, wheels and tires, clip leads, right angle geared hobby motor, solderless TT motor adapter board, ping pong ball, rubber band, cardboard chassis, and instructions. The BBC micro:bit (SB53386, above) is not included. **NE30215 – \$17.00**

C. Discovery Kit for BBC micro:bit

Gr. 6–8 Get students started with coding and electronics. This kit has five experiments and everything needed to complete them. Each experiment has a complete code walk-through, a circuit diagram and a top-down breadboard view, full explanations, and descriptions of how the electronics work. Kit includes a breadboard breakout, small prototype breadboard, LED lights, resistors, buzzer, jumper wires, and a tutorial booklet. The BBC micro:bit (SB53386, above) is not included. **NE30215 – \$17.00**

NE30215 – \$17.00

NEW

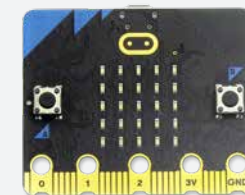

Kitronik micro:bit V2 Go Pack

BBC micro:bit with USB cable, batteries, and holder. Features USB, radio, serial, and Bluetooth Low Energy connectivity and a fully programmable 25 LED display.

NE30611 – \$32.00

Inventor's Kit for BBC micro:bit

Offers an introduction to the world of physical computing. Experiments showcase how code and electronics can combine to create practical solutions to situations and problems. Contains everything needed to complete 10 experiments. Required but not included: BBC micro:bit (SB53386, above), Phillips screwdriver, terminal block screwdriver, and micro USB cable (SB53385).

SB53372 – \$32.50



Lesson in a Box™ Simple Robotics Curriculum

A complete set of electronics and teaching resources to enable successful STEM lessons incorporating robotics, coding, and physics with minimal teacher effort. Students learn to code robots that utilize BBC micro:bit and a clippable motor driver board. Includes 10 student sets and one teacher set of electronics, as well as a USB stick drive with lessons and instructions. Required but not included: BBC micro:bit (SB53386, above) and 3 "AA" batteries per robot. **SB53369 – \$605.00**

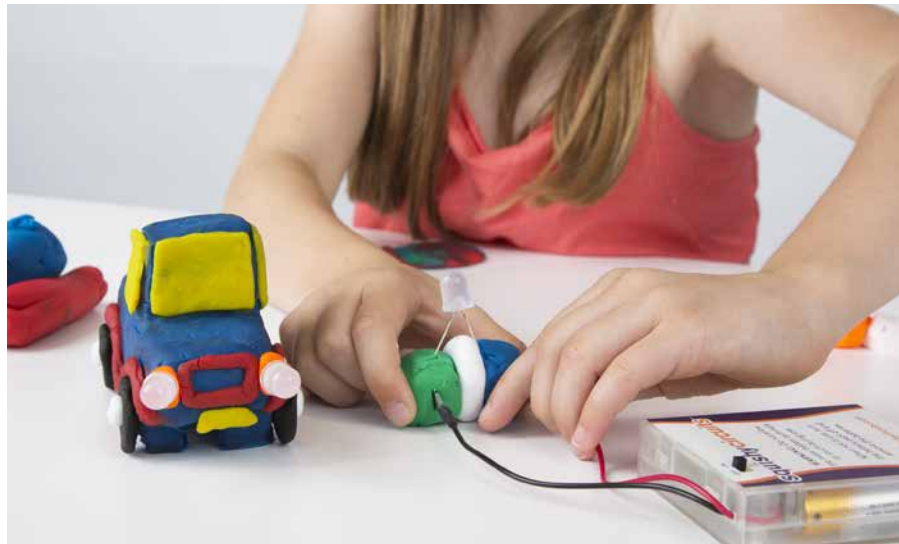

Dough Kit
Includes 7 containers of conductive dough (7 oz. each) and 7-oz. container of white insulating dough. Conductive dough will dry out if left out of container. Insulating dough does not dry out (below). Contains gluten. Safe and nontoxic.
SB52805 – \$20.00



NZ10371
Intro Classroom Kit



Circuit Scribe Circuit Drawing Kits

Now students can turn their doodles into real prototypes. The conductive pens included in this kit can be used on regular printer paper to create connections between power sources and other magnetic modules. Students place the paper on the included steel sheets and attach different modules to make blinking lights, beeping buzzers, and whirling motors. **CHOKING HAZARD (I).** Not for under 3 yrs.

EXCLUDED FROM DISCOUNTS



Squishy Circuits®
Gr. 3+ Use conductive and insulating play dough to teach the basics of electrical circuits in a fun, hands-on way. No need for breadboards or soldering. Just add batteries and pre-made dough (or make your own dough with recipes provided). Creations come to life as you light them up with LEDs, make noises with buzzers, and spin with the motor.

A. Group Kit. 10 battery holders (each holds 4 “AA” batteries, not included), 10 piezoelectric buzzers, 10 switches, 10 motors with propellers, 80 LED (10 each of 8 colors), and carrying case. Purchasing 2 dough kits is recommended. **CHOKING HAZARD (I).** Not for under 3 yrs.
SB52852 – \$275.00

B. Lite Kit. Battery holder (holds 4 “AA” batteries; not included), container of conductive dough (5-oz.), 15 LEDs (10 mm — 5 each of 3 colors), recipe card, and quick start guide. **CHOKING HAZARD (I).** Not for under 3 yrs.
SB52817 – \$15.95

C. Deluxe Kit. Battery holder (holds 4 “AA” batteries, not included), piezoelectric buzzer, mechanical buzzer, motor with fan blades, switch, 40 LEDs (10 mm — 5 each of 8 colors), 5 sculpting tools, rolling pin, 7-oz. container of white insulating dough, 7 containers of conductive dough in 7 colors (each 7 oz.), recipe card, and quick start guide. **CHOKING HAZARD (I).** Not for under 3 yrs.
SB52815 – \$75.95

D. Standard Kit. Battery holder (holds 4 “AA” batteries, not included), piezoelectric buzzer, 25 LEDs (10 mm — 5 each of 5 colors), recipe card, and quick start guide. **CHOKING HAZARD (I).** Not for under 3 yrs.
SB52816 – \$35.00

E. White Insulating Dough
Won't dry out if left in open air. 7 oz.
SB52806 – \$6.00

Build your wish list and email it at nascoeducation.com

Components	NZ10371 Intro Classroom Kit	NZ10372 Everything Classroom Kit
Conductive Ink Pens	30	30
9V Battery Adapters with 9V Battery	25	25
USB Adapters	—	5
LEDs	25	50
Switches	25	25
Buzzers	5	25
Multicolored LEDs	5	25
Double Switches	2	25
Motors & Foam Wheels	2	25
Dials	2	25
Blinkers	2	10
Dimmers	—	—
DIY Connectors	—	10
NPN Transistors	2	10
Light Sensors	—	10
Steel Canvases	25	25
Stencils	25	25
Workbook	1	1
Jumper Sticker Set	1	1
Connector Cables	20 (2 packs of 10)	40 (4 packs of 10)
Each	\$1,000.00	\$2,000.00



NZ10372
Everything Classroom Kit



Circuit Scribe Conductive Ink Pen

This conductive pen can be used on any surface you can use a rollerball pen on to create connections between power sources and other components. The smooth flowing ink produces wide, skip-free lines that are highly conductive. Each pen features nontoxic and quick-drying ink and can draw 66–219 yds., depending on the writing surface and speed (66 yds. on absorbent surfaces and 200+ yds. on photo paper). Photo paper will provide the highest conductivity (<2 ohms/cm) and allow you to scratch a trace away. **CHOKING HAZARD (I).** Not for under 3 yrs.
SB53196 – \$8.50

Create circuits without wires or metal soldering!

EXCLUDED FROM DISCOUNTS



ENGINO® STEM

The innovative, modular ENGINO building system was developed by STEM experts for open projects and engineering challenges for all age groups. The patented design enables students to quickly and easily build fully functional technological models and increase the complexity as they grow.

Easy-to-follow building instructions for all models can be found online or in the included booklet. The ENGINO digital curriculum platform includes lesson plans, building guides, sample programs, and more. KEIRO™ software is compatible with Windows, Android, Mac, and Linux. ⚠ CHOKING HAZARD (I). Not for under 3 yrs.



A. ENGINO® STEM & Robotics Mini Set
Gr. 2–6 Build 40 functional robotic models. For groups of 2–3 students. Includes 312 parts, mini controller, 2 DC motors, 1 LED, 2 IR sensors, 1 touch sensor, and more in a plastic storage tub. Requires 3 AAA batteries (not included).
NE30544 – \$399.99

B. ENGINO® STEM & Robotics PRO Set
Gr. 7–12 Build 30+ functional robotic models. For groups of 2–3 students. Includes 369 plastic parts, Pro controller, 3 DC motors, 5 LEDs, 2 IR sensors, 1 touch sensor, and more in a plastic storage tub. Requires 6 AA batteries (not included).
NE30545 – \$499.99

ENGINO® STEM Mechanics: Levers, Linkages & Structures
Gr. 5–12 Construct 16 different working models that explore how levers are used to lift heavy objects, including a seesaw, a parking gate, a pantograph, and a double deck bridge. 38-page booklet.
NE30546 – \$28.99



C. ENGINO® STEM: Newton's Laws & Inclined Planes
Gr. 5–12 Construct 6 different working models that explore the properties of energy and energy conversion, including a crash test rig, a rocket launcher, and a bow and arrow. 33-page booklet.
NE30547 – \$34.99

ENGINO® STEM Mechanics: Levers & Linkages
Gr. 5–12 Construct 16 different working models that explore how to connect many levers together and how these linkages can be applied to various machines, including a seesaw, a movable weight scale, and a folding platform. 38-page booklet.
NE30548 – \$34.99

D. ENGINO® STEM Mechanics: Pulley Drives
Gr. 5–12 Construct 8 different working models that explore how pulley drives can be used to transfer and increase force, including a stationary bike, a crane, and a windmill. 30-page booklet.
NE30549 – \$44.99

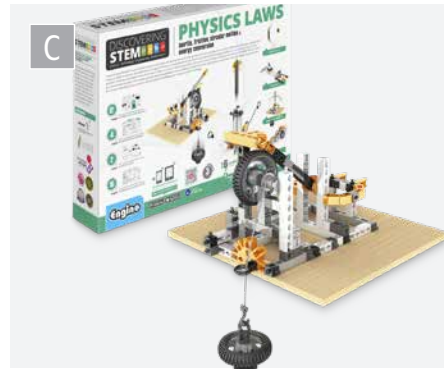

ENGINO® STEM Mechanics: Cams & Cranks
Gr. 5–12 Construct 8 different working models that explore how cams and cranks transmit power and convert reciprocal to linear motion, including an oil pump, a sewing machine and a flying eagle. 30-page booklet.
NE30550 – \$44.99

E. ENGINO® STEM Mechanics: Gears & Worm Drives
Gr. 5–12 Construct 12 different working models that explore how gears and worm drives can affect speed, force, and motion, including a car-ousel, a helicopter, and a screw press. 42-page booklet.
NE30551 – \$44.99

F. ENGINO® STEM Structures: Buildings & Bridges
Gr. 5–12 Construct 9 different working models that explore the importance and challenges of architectural design, including a house, a pyramid, and various types of bridges. 34-page booklet.
NE30552 – \$39.99



G. ENGINO® STEM Newton's Laws: Inertia, Momentum & Energy
Gr. 5–12 Construct 8 different working models that explore Newton's laws of motion, including a ballistic catapult, a gravity fan, a collision car, and a moving cabin. 37-page booklet.
NE30553 – \$44.99

ENGINO® STEM Astronomy: Traveling to Space
Gr. 5–12 Construct 6 different models that will teach students all about space exploration, including a rocket, a landing pot, a space robot, and a space shuttle. 37-page booklet included.
NE30554 – \$28.99

ENGINO® STEM Solar Power: Converting Sunlight to Electricity
Gr. 5–12 Explore the potential of the sun by building 16 solar-powered models, including a chopper car, a fan, a plane, a robot, and a winch crane. 34-page booklet.
NE30555 – \$89.99

ENGINO® STEM Simple Machines
Gr. 5–12 This set combines the basic 5 sets of the Discovering STEM series and covers all simple machine mechanisms. Students will build 60 working models that cover levers, wedges, wheels and axles, screws, inclined planes, pulleys, and more advanced gears and linkages. 182-page booklet.
NE30556 – \$89.99



ENGINO® STEM Botanic Laboratory
Gr. 5–12 Build a fully functional greenhouse model and control the temperature, moisture, and light levels. Besides all the build components, kit also includes 12 pots, a tray for growing plants, and a 10 ml plastic syringe for watering. Seeds and soil not included. 34-page booklet included.
NE30557 – \$99.99

H. ENGINO® STEM: Qboidz™ Set
Gr. PreK–2 Developed for larger groups of young students to participate in endless creative building! Qboidz components are easy for preschoolers to work with while also being fully compatible with standard ENGINO parts. Includes 195 plastic parts that can build 90 different models. For groups of 3–4 students.
NE30558 – \$149.99

I. ENGINO® FaceBot: Tangible STEM Qboidz™ & Robotics Set
Gr. K–3 Qboidz building components allow more than 20 models to be created by young students, and robotics components and amazing FaceBot step up complexity for the older grades. Includes 278 plastic parts, battery compartment for 3 AAA batteries (not included), mini controller, 35 tangible blocks of different commands, line-following mat with colored stations, board game with coding challenges, 4 interchangeable faces, 2 dual sensors (proximity and color), 2 DC motors, 1 LED, 1 touch sensor, and a storage tub. For groups of 2–3 students.
NE30559 – \$399.99

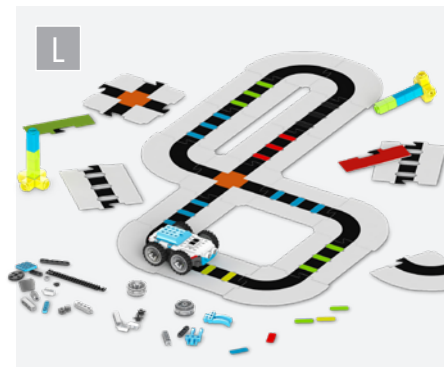

ENGINO® STEM Solar Power Complete Set
Gr. 5–12 Show students all the ways we can use solar power. Includes one 3V solar panel that powers an electrical motor, along with digital instructions for 16 solar-powered models such as a chopper car, a plane, and a robot. Requires 3 AAA batteries (not included).
NE30561 – \$69.99

J. ENGINO® STEM Simple Machines Set
Gr. 7–12 Quickly and easily build 60 working models that use simple machines. For groups of 2–3 students. Includes 191 plastic parts, gearing system, and pulleys system.
NE30562 – \$69.99

K. ENGINO® GinoBot™ Basic Edition
Gr. 5–12 GinoBot is a highly programmable robot ready to be used straight out of the box! Students can expand their robot with ENGINO parts. Features 3 proximity sensors, 2 floor color sensors, and 2 encoder motors. Connectivity via USB, Bluetooth, and Wi-Fi. Can be programmed with KEIRO™ software. Can also be programmed with Python and C++ once a BBC micro:bit or Arduino are installed (not included). For groups of 3–4 students.
NE30560 – \$199.99

L. ENGINO® Robotic Challenge: Flexi-Track Puzzle
Gr. 5–12 Do you need a better system for students to test their programmed robots? This modular set of large-scale floor mats is the answer! Mats are corrugated plastic puzzle pieces that are easy to store. Also includes 20 Qboidz parts and a Flexi-Track puzzle for GinoBot™ featuring a printed black line with slots for colored pieces to be inserted. GinoBot sold separately.
NE30563 – \$69.99

ONLY AT NASCO

EXCLUDED FROM DISCOUNTS

Grade-level adaptations
in teachers guide

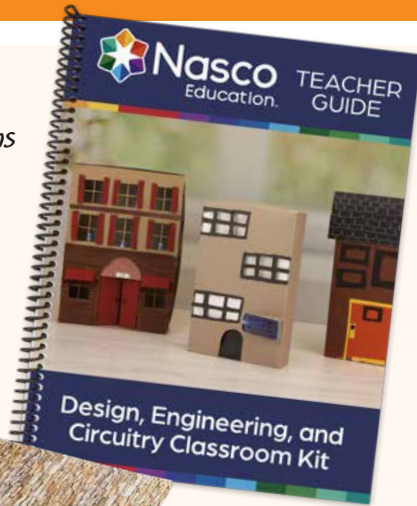

Nasco Design, Engineering, and Circuitry Classroom Kit
Gr. K-12 With this highly adaptable unit, students will work in small groups to combine their architectural engineering and circuitry skills with creativity to design a home or storefront that lights up. Includes 70-page teacher's guide with reproducibles and everything you need for 30 students to complete the unit.
⚠ CHOKING HAZARD (1). Not for under 3 yrs.
NE30254 — \$219.95

 **Video alert!** Visit nascoeducation.com to see it in action (search NE30254)



Mr. Playwood Alexandria Lighthouse Eco-Light Kit
Gr. 8+ Explore the ancient Lighthouse of Alexandria. Hand-crank electric generator lights up a small LED lamp at the top of the structure — no batteries! Laser-cut plywood. No glue needed. Includes step-by-step instructions. 280 pieces. ⚠ CHOKING HAZARD (1). Not for under 3 yrs.
NE30469 — \$81.95

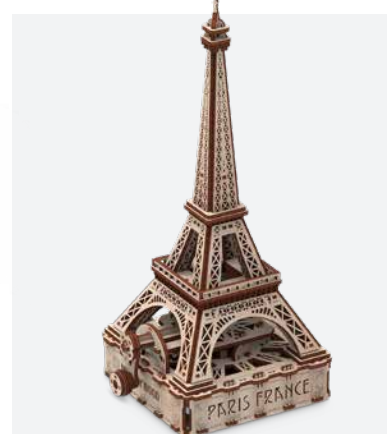

Mr. Playwood Eiffel Tower Eco-Light Kit
Gr. 8+ Get a close-up view of the Eiffel Tower. Hand-crank electric generator lights up a small LED lamp at the top of the structure — no batteries! Laser-cut plywood. No glue needed. Includes step-by-step instructions. 163 pieces. ⚠ CHOKING HAZARD (1). Not for under 3 yrs.
NE30468 — \$81.95



Roller Coaster Engineering
Gr. K+ Introduce students to the ups and downs of designing and building dozens of working roller coaster models. As they complete challenges they'll experiment with variables such as car weight, slope, and length. Give them a practical and fun introduction to physics principles, including gravitation, potential energy, kinetic energy, projectile motion, friction, centripetal force, velocity, and acceleration. Includes 330 pieces and a 32-page guide. ⚠ CHOKING HAZARD (1). Not for under 3 yrs.
NE30147 — \$49.95

BEST SELLER



Model Bridge Classroom STEM Pack
Design and construct wooden bridges, enjoy the thrill of destructive testing, then calculate each bridge's efficiency to determine the best design. Build bridges from either strong $\frac{3}{32}$ " x $\frac{3}{32}$ " x 24" basswood with consistent density or light, easy-to-cut $\frac{1}{8}$ " x $\frac{1}{8}$ " x 24" balsa wood. For 24 students.
SB23608 Basswood **SB23609 Balsa**
Each — \$99.95



KEVA® Maple Structures
Children can build bridges, sculptures, houses, and towers taller than themselves with these high precision maple construction blocks that stack with surprising stability without any connectors. Every plank is the same size ($4\frac{1}{2}$ " x $\frac{3}{4}$ " x $\frac{1}{4}$ " thick).
200-Piece Set. Includes 2 plastic storage bins and instruction/game book.
SB46106 — \$124.95
400-Piece Set. Includes 2 plastic storage bins and instruction/game book.
SB46105 — \$199.95



KEVA® Structures Kit
Gr. K+ Stack pine wood planks to create ornate buildings, monuments, and geometric forms. No glue or connectors required. For 1 or more students.
SB49047 — \$59.95



KEVA® Contraptions™ Kits
Gr. 2+ No glue or connectors needed. Get things rolling with 2 balls, pine planks, and instruction book detailing how to build a "shooting gallery," "turbine," "step curve," and more. For 1 or more students. ⚠ CHOKING HAZARD (4). Not for under 3 yrs.
SB49050 50-Piece Set — \$22.95
SB49049 200-Piece Set — \$59.95



Polydron STEM Set
Gr. 5+ Build STEM learning to a higher level with this comprehensive set. With the use of detailed, double-sided work cards and activities, introduce STEM principles to students so they can take what they've learned and construct a variety of intermediate and advanced engineering projects. Set includes a detailed teacher guide, 22 work cards, and a variety of pieces for students to use when constructing projects. ⚠ CHOKING HAZARD (1). Not for under 3 yrs.
NE30206 — \$399.95



Kemtec™ Structures & Bridges Kit
Gr. 7+ Students will gain knowledge of structural engineering and how it is used to support or resist loads. Study different types of bridges and the STEM principles that support them. Construct 6 working models including a house, suspension bridge, cable-stayed bridge, arch bridge, and 2 different truss bridges. Students will also be challenged to build the largest free-standing tower in the class using the kit components. Finally, the students will need to apply all they have learned to build a bridge that spans 70 cm and will support a minimum distributed static load of 2 kg using only 100 plastic straws and a limited amount of masking tape. For 24 students working in 6 groups of 4. Kit contains 6 sets Engino® structures and bridges parts, 6 Engino® 36-page activity books, 6 Engino® 26-page building instructions, dowel rod, 6 rulers, spring scale, string roll, masking tape, 600 straws, 6 scissors, 24 student worksheets, and teacher's manual with lesson plans. ⚠ CHOKING HAZARD (1). Not for under 3 yrs.
SB49883 — \$699.95

INSPIRE YOUR STUDENTS
with team problem-solving and model building

The K'NEX® building system is an endless flexible tool you can use to get students engaged in hands-on exploration and help them understand and remember important science concepts. Sets are available for a wide range of skill levels and each is designed for small groups to explore and build multiple models throughout the year.

Science sets include:

- A teacher's guide or illustrated manual filled with activities that align with state and national education standards
- Enough K'NEX® pieces for groups to build multiple models



Look online for free sample lessons and key concepts addressed in each set

BEST SELLER

K'NEX® Education Maker Kit Large
Gr. 5+

- Models demonstrate STEM through replicas of real-world machines
- Over 800 parts and 100 building ideas to build an ambulance, guitar, space shuttle and more
- Rods and connectors facilitate hands-on exploration
- Supports 2-3 students working as a team

⚠ CHOKING HAZARD (1). Not for under 3 yrs.
ELI5799 – \$134.95

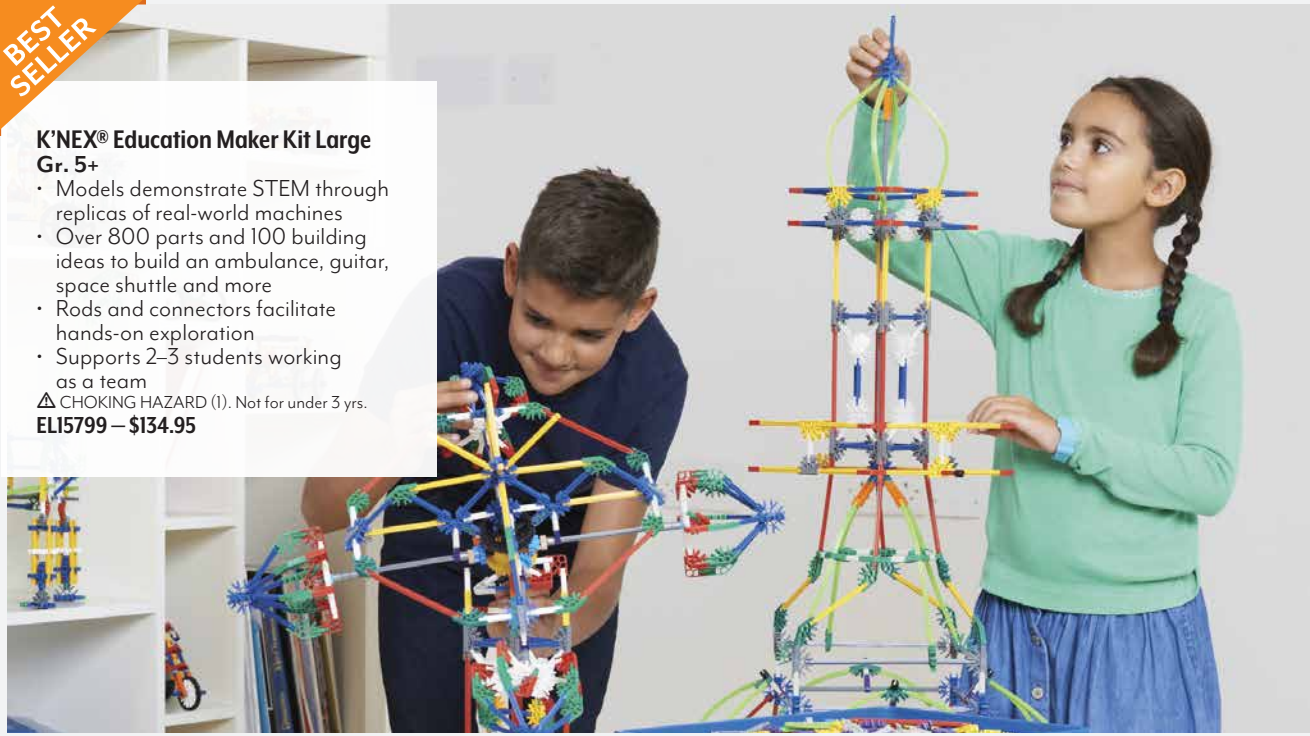

K'NEX® Introduction to Bridges
Gr. 5-8

- Models demonstrate 7 key bridge types (arch, beam, bascule, cantilever, cable-stayed, truss, and suspension)
- 207 pieces to build 13 bridge models
- Supports 2-3 students working as a team
- Instructional guide

TB20794 – \$46.95



Builds 13 models

Builds 7 models

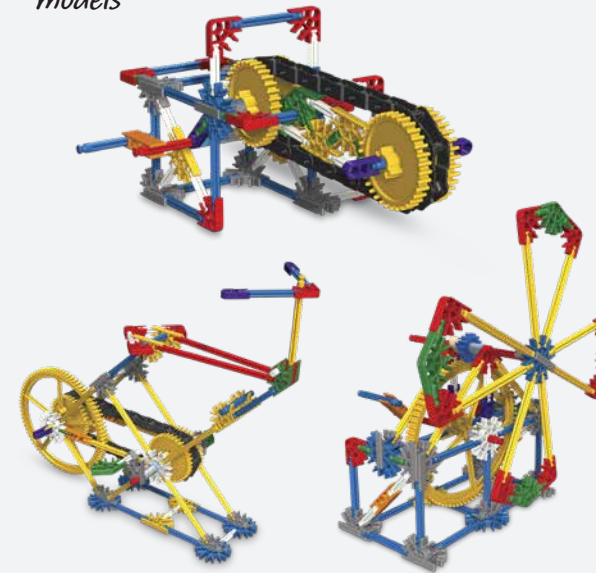

K'NEX® Intro to Simple Machines: Gears
Gr. 5-8

- Demonstrates spur, crown, chain, and sprocket gear assemblies
- 198 pieces to build 7 models, all replicas of real-world machines
- Supports 2-3 students working as a team
- Instructional guide

SB36649 – \$46.95

Builds 7 models

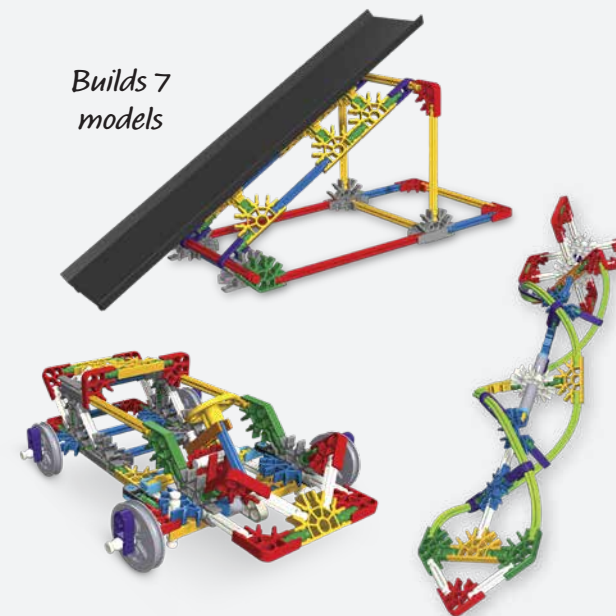

K'NEX® Intro to Simple Machines: Wheels/Axes and Inclined Planes
Gr. 5-8

- Demonstrates wheel and axles and inclined planes including a wedge and screw
- 221 pieces to build 7 models (all replicas of real-world machines)
- Supports 2-3 students working as a team
- Instructional guide

⚠ CHOKING HAZARD (1). Not for under 3 yrs.

SB36638 – \$46.95

Builds 70 models



K'NEX® Imagine Classic Constructions Building Set

Create working vehicles, animals, moving structures, buildings, and more — the possibilities are endless. Plastic rods and connectors join up with a satisfying “click.” Includes over 700 pieces with storage chest and illustrated manual with over 70 building ideas.

ELI6198 – \$47.95

K'NEX® Roller Coaster Building Set

Gr. 5-9 Build a working roller coaster. Supports 2-3 students. Over 500 parts, battery-powered motor, and downloadable booklet. Builds 3 models. ⚠ CHOKING HAZARD (1). Not for under 3 yrs.

ELI5289 – \$50.95



Builds 8 models

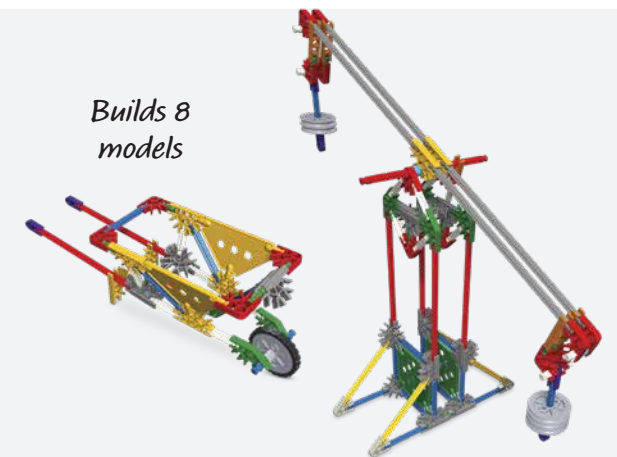

K'NEX® Intro to Simple Machines: Levers and Pulleys

- Demonstrates 3 lever classes and fixed, movable, and combination pulley systems
- 178 pieces to build 8 replicas of real-world machines, one model at a time
- Supports 2-3 students working as a team
- Instructional guide

SB36650 – \$46.95

Updated in 2024!

Nasco Classroom Olympiad Part 1
Gr. 3-8 Each event encourages cooperative learning and fosters an understanding of the scientific method. Events include aerodynamics, car race, Cartesian divers, domino event, egg drop crate, regatta, rubber band catapult, suspension bridge, sky's the limit structures, and slow roller. Updated in 2024. **CHOKING HAZARD (1)**. Not for under 3 yrs. **SB31527 – \$162.00**

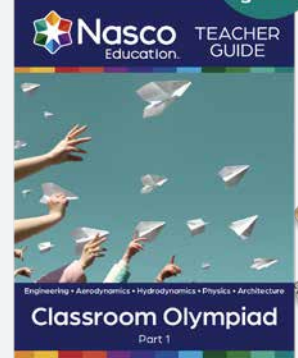

ONLY AT NASCO



Nasco Classroom Olympiad Part 2
Gr. 3-8 Keep the spirit of Olympic competition alive as your students learn the scientific method and cooperative learning skills. The 9 events include sailing, fettuccine physics, estimation guesstimation, shadow box, air cannon, marble trampoline, balloon bomber, pencil pendulum, and battery-powered car. **CHOKING HAZARD (1, 2)**. Not for under 3 yrs. **SB42632 – \$270.00**

ONLY AT NASCO

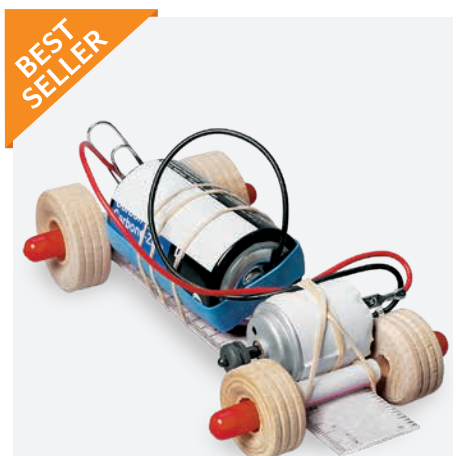

Science Car Kit
Gr. 5+ Make a car while exploring topics such as circuits, switches, and pulley/gear ratios. Finished dimensions: 6" x 3". Size "D" batteries required (not included). **CHOKING HAZARD (1)**. Not for under 3 yrs. **SB27491 – \$12.95**



Mousetrap Dragster Kit
Students experience exciting involvement with technology problem solving, the physics of energy transference, aerodynamics, thrust, vector, and friction. Glue required (not included). Set of 5 kits. **SB26052 – \$37.95**



Heavy-Duty Alkaline Batteries
Size "D" batteries ideal for general lab work. Super cells provide up to twice the life of ordinary general-purpose cells. Pkg. of 2. **SB08606 – \$2.25**

Thames & Kosmos Remote Control Machines Experiment Kit
Gr. 3-8 Build motorized vehicles and machines and control them with a wireless remote control unit. A unique six-button infrared remote allows you to control three different motors simultaneously, moving each of them forward or in reverse, with easy-to-activate touch sensors. The three motors can be combined to make complex vehicles and machines in numerous configurations limited only by your imagination. Assemble 10 models demonstrating different ways in which the motors can be used including a bulldozer, car, three-wheeler, crane, antique car, plow, folding car, formula one racer, three-blade dozer, and robotic arm. Kit comes with three motors, remote control unit, battery holder, and building blocks. The 48-page color instruction book gives illustrated step-by-step instructions to help develop mechanical understanding, creative thinking skills, and hand-eye coordination. 182 pieces. **SB49206 – \$105.95**



Combine and control 3 motors simultaneously to create complex machines

fischertechnik® Construction Kits
This flexible construction system is built around the fischertechnik® building block, which allows attachment to all 6 sides. Each kit includes access to a library of downloadable teaching and tutorial materials. Recommended for 2-4 students per set. **CHOKING HAZARD (1)**. Not for under 3 yrs.
STEM Pneumatics. Gr. 6+ Students will build 8 different models and conduct 29 experiments that teach and demonstrate the basic principles of pneumatics. **NE30144 – \$215.00**
STEM Renewable Energies. Gr. 6+ Building 9 functional models and conducting 28 experiments teaches students about generating, storing, and using different types of renewable energy. **NE30145 – \$345.00**



Thames & Kosmos Rubber Band Racers
Gr. 2+ Build 5 vehicles using ultralight plastic and bamboo parts. Learn how rubber bands store energy and release it to move the models. **EL15549 – \$21.95**



Thames & Kosmos The Big Engineering Makerspace
Gr. 2+ Kit explores different areas of physics and engineering design by having students build 22 functional models and conduct tests with them. Explore submersibles, rotation, statics, and more. Includes 267 pieces and a 128-page manual with step-by-step instructions. **CHOKING HAZARD (1)**. Not for under 3 yrs. **SB53344 – \$99.95**

That's just the start!
See more options at nascoeducation.com

Eco-Wood-Art Construction Kits

Gr. 8+

This eco-friendly sustainable material is made of FSC-certified, laser-cut plywood with amazing details. The plywood can be painted with thin water-based paints. Self-assembly is required. There's no need for glue or batteries. Kits include wood material, candle wax for gears, sand paper, rubber bands, and step-by-step assembly instructions inside of an all-inclusive box. ⚠ CHOKING HAZARD (I). Not for under 3 yrs.



NE30197



NE30198



Product No.	Description	Each
NE30176	Cruiser Construction Kit	\$33.95
NE30177	Mini Belaz Construction Kit	\$26.95
NE30179	Da Vinci Tank Construction Kit	\$55.95
NE30186	Tank T-34-85 Construction Kit	\$76.95
NE30188	Locomotive Construction Kit	\$55.95
NE30190	Trebuchet Construction Kit	\$41.95
NE30191	Goggles Construction Kit	\$25.95
NE30192	Kinetic Globe Construction Kit	\$45.95
NE30193	Game Set Construction Kit	\$61.95
NE30195	Globe Blue Construction Kit	\$102.95
NE30197	Planetary Gear Construction Kit	\$49.95
NE30198	Table Football Construction Kit	\$45.95
NE30200	Spider Construction Kit	\$50.95

BUILD WORKING MODELS of historical and modern contraptions



NE30177



NE30186



NE30190



NE30176



NE30191

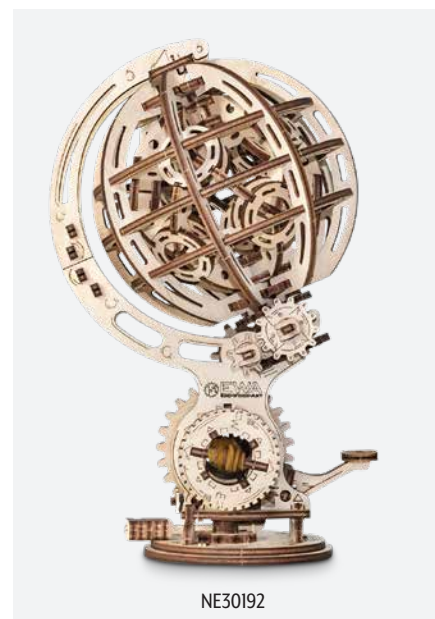

NE30192

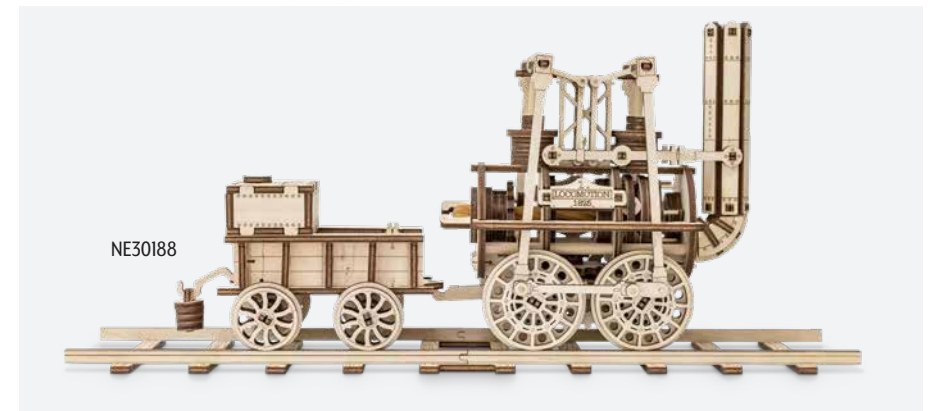

NE30188



The Hoberman Sphere™
Polymer links expand and contract almost effortlessly, changing in volume 30 times. Expands from 9½" to 30".
TB18334 – \$36.50



Magformers® STEAM Basic 200-Piece Set
Gr. PreK+ Perfect for developing children's scientific thinking, curiosity for building, and mathematical thinking. Click and connect STEAM engine blocks to create walking robots and space stations. Follow instructions to build walking animals, moving vehicles, and spinning towers. Students will learn about gear systems, kinetic motion, and pistons, taking their STEM education to the next level. Easy-to-use magnetic pieces always attract, never repel, and are compatible with all Magformers® shapes and accessories (excluding XL shapes). Pieces are made of high-quality ABS plastic and contain ½" rare-earth neodymium magnets on the sides. Includes 22 geometric shapes, 36 accessories, and S.T.E.A.M. idea booklet and play sheet. **CHOKING HAZARD (I)**. Not for under 3 yrs.
ELI3774 – \$409.95



Lux Blox™
Gr. K-12 Pieces link together on all sides instead of stack. Creations bend, flex, and move like no other construction toy. Build models while exploring concepts in disciplines like biology, chemistry, math, physics, engineering, and more. Multi-wheels can also function as gears and pulleys. **CHOKING HAZARD (I)**. Not for under 3 yrs.



Thames and Kosmos® Gecko Run Marble Run Starter Set
Gr. 3-8 Flexible tracks allow students to turn doors, windows, or any smooth surface into part of the track. Tracks attach with nano pads, which create a strong but temporary bond and can be easily repositioned for design iteration. Promotes hands-on experimentation, problem-solving through trial-and-error, and creativity. Includes 16-page illustrated manual.
NE30500 – \$34.95



Gear Set
This 300-gear set offers 40-, 30-, and 20-tooth gears (with a 3/16" bore to accommodate dowel) and a 12-tooth gear with a push into 2 mm motor shafts.
SB26469 – \$55.95



Lux Blox™ STEAM Primer
Set of 111 total pieces: 75 squares (red, yellow, blue); 20 white trigons; 5 multi-wheels; 4 square multi-wheels; 5 axles; and 2 giant 7" rubber bands. Comes in a 10"H clear tube with lid.
NE30009 – \$43.00



Lux Blox™ STEAM Inventor
Set of 223 total pieces: 40 red squares; 130 white squares; 35 white trigons; 2 trigon multi-wheels; 4 square multi-wheels; 10 axles; and 2 giant 7" rubber bands. Comes in a 14"H clear tube with lid.
NE30010 – \$66.99



Lux Blox™ Build Anything Bin
1,000 total pieces with 100 squares of each color: neon orange, teal blue, neon green, purple, royal blue, neon pink, yellow, red, white, and black. Includes a durable storage tote.
NE30011 – \$215.00

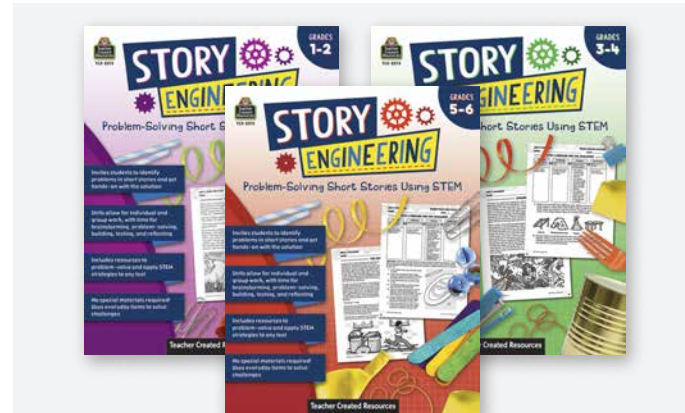

Story Engineering Books: Problem-Solving Short Stories Using STEM
Approach STEM problem-solving skills with literacy to get the most out of limited class time. Students read fictional passages, then solve the problems using STEM/engineering design process and everyday materials. Each book contains 11-12 units, each on focusing on one problem and one challenge, with additional problems for future challenges. Use for individual or group work. Includes teacher overview, lesson plan, and activity sheets.
NE30098 Gr. 1-2 **NE30099 Gr. 3-4** **NE30100 Gr. 5-6**
Each – \$14.95



STEM Challenge Cards
Gr. 1-6 Dive into STEM with simple challenges that can be completed using everyday items. Perfect for individual or whole-group STEM activities. Each card includes tips, a simple explanation of the science concept involved, and an extension question for each area of STEAM. Online resource available for more in-depth experiments. 3 tabbed dividers and 30 coated, write-on/wipe-off cards (each 7¾" x 5½").
TB27187 STEM Challenge Cards
TB27188 Seasonal STEM Challenge Cards
Box – \$18.00



Lux STEAM Accelerator Deluxe Classroom Set
Includes 800 squares; 300 trigons; 40 each of large and small multi-wheels; 40 each of large, medium, and small axles; 40 giant 7" rubber bands; laminated starter guide; extensive teacher's primer, and plastic storage unit.
TB27602 – \$472.00



Lux STEAM Accelerator Small Group Set
Set includes 400 squares; 200 trigons; 20 each of large and small multi-wheels; 20 each of large, medium, and small axles; 20 giant 7" rubber bands; laminated starter guide; extensive teacher's primer, and plastic storage unit.
TB27603(B) – \$305.00



Nasco Simple Building Materials Kit
Immerse students in STEAM exploration in the classroom or makerspace with this economical assortment of materials for building simple STEAM projects. Perfect for a classroom of 24 students. Includes 3 lesson plans. ⚠️ CHOKING HAZARD (1). Not for under 3 yrs. **TB27626 – \$126.95**



Mega Cyborg Hand
Gr. 1+ Use the plastic pieces and piston tubes to build a mechanical hand that uses hydraulic power to simulate the movements of the human hand – no motors or electricity required. Once assembled, the cyborg hand slips onto your hand like a glove, with mechanical fingers that you operate with your own fingers. The hand can be configured left-handed, right-handed or claw-like. Includes 203 pieces and 40-page guide. **NE30116 – \$40.95**



3Dux GO-Pack Maker Kits – Set of 8
Gr. K+ Perfect for the makerspace, classroom and distance learning. Each kit includes a 3DuxDesign backpack, over 50 geometric cardboard shapes, 45 assorted connectors, string, straws, copper fasteners, pom poms, pipe cleaners, graph paper, ruler and animal figurine. Also includes downloadable ideas. ⚠️ CHOKING HAZARD (1). Not for under 3 yrs. **NE30104 – \$224.95**



3DuxDesign Architectural Modeling Kits
Cardboard construction system integrates art, design, and open-ended creative play with STEM fundamentals. Building sets provide everything students need to create a featured structure, as well as additional pieces to expand the set or to build their own creations. Can be used for architecture, urban planning, engineering, 3-D modeling, and prototyping. Connectors work with most single-ply cardboard. ⚠️ CHOKING HAZARD (1). Not for under 3 yrs.

GOBOX Pro Classroom Kit. Gr. 2+ Learn about circuits, renewable energy sources, and more by adding electricity to cardboard creations. Enough materials for 30 students working in groups. Includes links to downloadable curriculum.

BEST SELLER SB53285 – \$279.95

Rocket Ship. Gr. 2+ Includes 90 pieces. **SB53282 – \$26.95**

Fire Station. Gr. 1+ Includes 84 pieces. **SB53279 – \$24.95**

GOBOX Classroom Kit. Gr. K+ Enough materials for 30 students working in groups. Includes links to downloadable curriculum. **SB53283 – \$219.95**

Iconic Home. Gr. K+ Includes 83 pieces. **SB53280 – \$24.95**

Modern Museum. Gr. 1+ Includes 76 pieces. **SB53281 – \$25.95**

Jumbo Connector Set. 60 connectors in 6 designs. Assorted colors. **SB53284 – \$24.95**

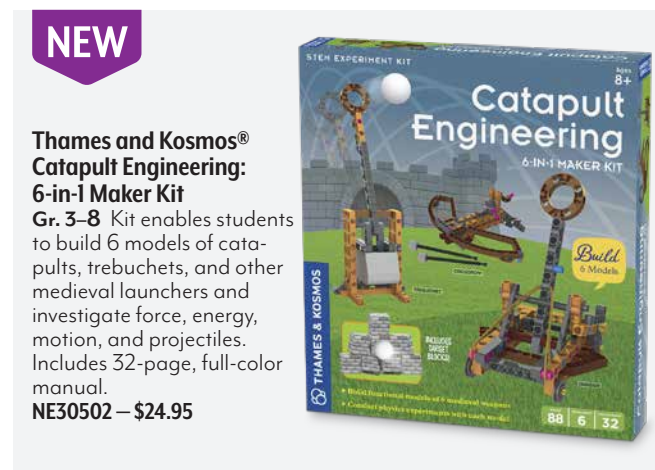

NEW
Thames and Kosmos® Catapult Engineering: 6-in-1 Maker Kit
Gr. 3-8 Kit enables students to build 6 models of catapults, trebuchets, and other medieval launchers and investigate force, energy, motion, and projectiles. Includes 32-page, full-color manual. **NE30502 – \$24.95**



Candy Claw Machine
Gr. K+ Build a working model of the classic claw machine. This STEM challenge will help students develop their motor skills and teach them about hydraulics, levers, gears, belts, end effectors, and more. When the included candy is gone, refill with your own small treats or toys. Includes 113 pieces and a 16-page guide. ⚠️ CHOKING HAZARD (1). Not for under 3 yrs. **NE30146 – \$39.95**

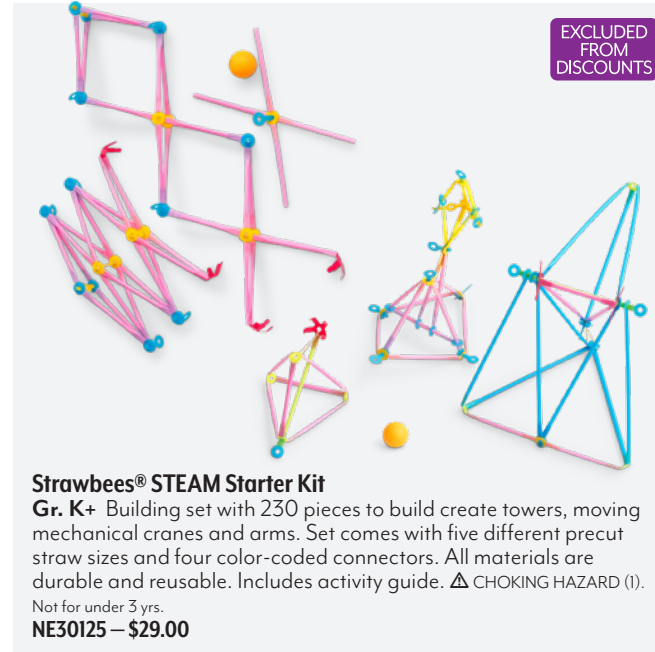

EXCLUDED FROM DISCOUNTS
Strawbees® STEAM Starter Kit
Gr. K+ Building set with 230 pieces to build create towers, moving mechanical cranes and arms. Set comes with five different pre-cut straw sizes and four color-coded connectors. All materials are durable and reusable. Includes activity guide. ⚠️ CHOKING HAZARD (1). Not for under 3 yrs. **NE30125 – \$29.00**



EXCLUDED FROM DISCOUNTS
Strawbees® STEAM School Kit
Gr. K+ Let students build anything they can imagine with the largest Strawbees kit available. Includes 4,000+ pieces and 100+ challenges. Comes with teacher and admin access to Strawbees Classroom – an online library of lessons, professional development, and student materials. For up to 30 students. ⚠️ CHOKING HAZARD (1). Not for under 3 yrs. **NE30327 – \$699.00**

Support hundreds of students with just one cart



TeacherGeek Maker Space/STEAM/STEM Activity Carts Gr. 3-12 Roll this cart into your classroom, lab, or library for the ultimate Maker/STEAM/STEM solution. Contains over 15,000 components and tools to complete more than 40 different STEAM/STEM projects. Includes a pallet of replacement supplies and tools to keep the cart stocked. Students will learn science and engineering concepts through experimentation, grow their understanding, and evolve projects through the design and engineering process. NGSS aligned.

Activity Cart, Maker Space Header

- NZ10450 Grape
- NZ10451 Strawberry
- NZ10452 Kiwi
- NZ10453 Blueberry

Activity Cart STEAM Header

- NZ10454 Grape
- NZ10455 Strawberry
- NZ10456 Kiwi
- NZ10457 Blueberry

Activity Cart STEM Header

- NZ10458 Grape
- NZ10459 Strawberry
- NZ10460 Kiwi
- NZ10461 Blueberry



The perfect kit to round out your makerspace!

Cool Art with Math and Science Kit

Complete materials for the 6 book series *Cool Art with Math and Science*. Enough materials for 24 students. Kit includes the book set and dozens of arts and craft supplies to complete the projects outlined in the books. All activities include how-to photos, easy instructions, and clear explanations. **SB53387 – \$955.00**



Nasco Beginner Makerspace Kit

All the materials you need to create your first makerspace place and encourage students to explore and be innovative. **CHOKING HAZARD (I)**. Not for under 3 yrs. **9742353 – \$452.65**

Nasco Individual Student Makerspace Kit

NE20103 – \$48.25



Nasco All About Fish Kits and Lesson Plans

Great STEAM lessons include multiple activities with kits curated by age group, using the ancient Japanese art of Gyotaku Fish Printmaking. Each contains enough materials for class of 24, lesson plan, rulers, paints/glazes/ink, brushes/rollers, drawing paper, gyotaku fish rubber stamps, and book. **CHOKING HAZARD (I)**. Not for under 3 yrs.

All About Fish Kit: Learn, Print, & Build, Gr. K-2

SB53388 – \$325.00

All About Fish Kit: Structure, Print, & Build, Gr. 3-5

SB53389 – \$430.00



Copernicus 3D Printer Cart

Features adjustable spool holder (for up to 4 spools), sliding laptop shelf (fits laptops up to 17"), magnets and hooks for hanging accessories, 1 big tub, 4" casters (2 locking), and 6-outlet power strip. Accommodates 3D printers with a footprint of up to 26½" x 24". Frame measures 36" x 24" x 59". Lifetime warranty.

Base Model. 4 open tubs.

Z48158 – \$629.95

Premium Model. Base Tech Tub® and 2 open tubs.

Z51405 – \$719.95

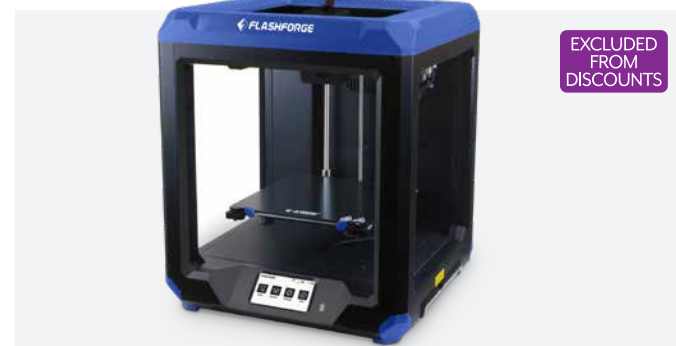
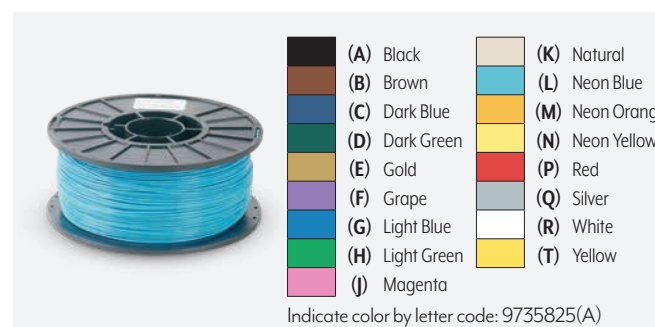

EXCLUDED FROM DISCOUNTS

FlashForge Artemis 3D Printer

Artemis is a cost-effective 3D printer that offers high-quality performance and reliability. Quiet printing is perfect for classrooms. Features include a removable glass platform, removable PEI magnetic steel plate platform, heatable build bed, filament detection sensor, and HD full-color touch screen. Print volume: 190 x 195 x 200 mm. Overall dimensions: 16" x 16½" x 18½". OS compatibility: Windows 7/10, Mac OS. See detailed specs at nascoeducation.com.

NE30329 – \$710.00



EXCLUDED FROM DISCOUNTS

FlashForge Adventurer 5M Pro 3D Printer

Join the high speed printing movement with unmatched performance and quality. Features include a 10-minute setup, one-click auto-leveling, vibration compensation, PEI removable and flexible build plate, quick-release nozzle, fully enclosed printing chamber, HEPA 13H filter system, and LCD touch screen. Print speed: Up to 300 mm/s. Maximum extruder temperature: 280°C (509°F). Print volume: 220 mm x 220 mm x 220 mm. Overall dimensions: 15" x 15.7" x 17.8". Compatibility: Windows® 7/8/10/11, Linux Ubuntu 20.04 and later, Mac® OS 10.9 and later. See detailed specs at nascoeducation.com.

NE30510 – \$750.00

PLA Filament

Created from plant products (corn, potatoes, or sugar beets), PLA is considered more earth-friendly compared to the petroleum-based ABS plastics. It's biodegradable and can be composted at most commercial facilities. Stronger and more rigid than ABS plastic. Printed objects will look and feel glossier than ABS. Can be sanded and machined. Do not leave in high temperatures (such as hot cars) since objects may deform and droop. When PLA is properly cooled, it has higher maximum printing speeds, lower layer heights, and sharper printed corners. Filament comes on a 2.2-lb. spool. 1.75 mm. **9735825 – \$34.95 Mix 10+ \$33.32**



But wait, there's more! Scan to browse the full selection of 3D Printers at nascoeducation.com

NEW

3Doodler® Flow Essentials 3D Printing Pen Set

Gr. 9+ This marvel of technology supports various 1.75 mm filaments, including PLA and ABS. Features an integrated LCD and permanently tethered USB-C power cable. Set includes 8 PLA mini spools, stencil sheet, guide, power adapter, and maintenance tool. Refill box includes 20 mini spools (16' each).

NE30511 Essentials 3D Printing Pen Set — **\$79.99**
NE30512 Filament Refill Box — **\$19.99**



EXCLUDED FROM DISCOUNTS

TAKE VIDEOS TO THE NEXT LEVEL
Turn any space into a top-notch multimedia studio

EXCLUDED FROM DISCOUNTS

Let students use these video production essentials to develop media production skills and create dynamic projects and presentations. Or use them yourself to make remote instruction more engaging for distance learners.

Retractable Green Screen

Optimized for chroma keying, the green screen allows you to drop any background in and change it as often as you like for more interesting and engaging online classroom environments. 58 1/4" W x 70 3/4" H. **NA10463** — **\$165.00**

Key Light Air

Premium LEDs with 1400-lumen output, adjustable swivel head. Connects wirelessly from your PC, Mac®, Android® device or iPhone® so you can adjust brightness and color with ease. **NA10464** — **\$135.00**

Stream Deck Mini

Enhance your onscreen activity with GIFs, images, videos and soundbites. You can even apply lower thirds and bookend your content with signature intro and outro graphics. **NA10465** — **\$105.00**

Cam Link 4K

Connect your DSLR, camcorder, or action cam to your PC or Mac®, and use it as a webcam in your favorite apps to make online classes more engaging. Superb quality at 1080p60 or even up to 4K at 30 frames per second. **NA10466** — **\$135.00**

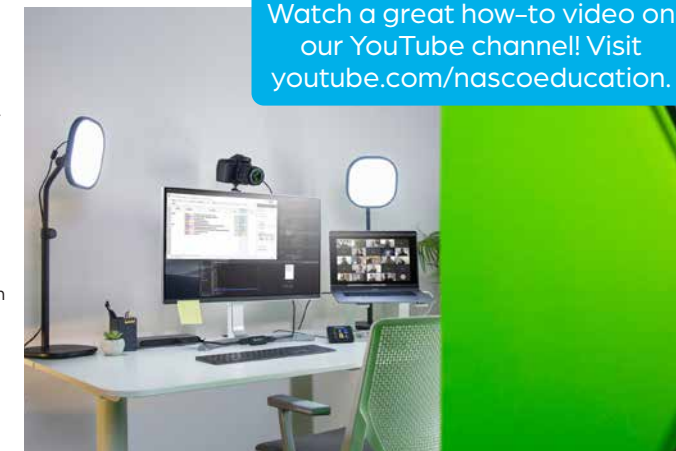

Watch a great how-to video on our YouTube channel! Visit youtube.com/nascoeducation.



Retractable Green Screen



Key Light Air

Cam Link 4K



Stream Deck Mini



Multi Mount Modular Rigging System (table not included)



Elgato Heavy Base



EXCLUDED FROM DISCOUNTS

3Doodler® EDU Start+ Learning Pack - 12-Pen Set

3Doodler® Start+ has no hot parts and is perfect for use with elementary students. Use to teach design, building, construction, spatial understanding, and a variety of other skills. Drives student engagement, confidence, and focus with hands-on learning. Each pack contains DoodlePads, DoodleBlocks™, USB cables, teacher's checklist, cheat sheet, manual, 3Doodler® poster, 2 lesson plans, 2 unblocking tools, EDU booklet, activity guide, DoodleBlock™ guide, troubleshooting guide, and free app. Contains 1,200 plastics (150 each of 8 colors) and 12 each of Start pens. **CHOKING HAZARD (1)**. Not for under 3 yrs.

NA10337 — **\$605.00**



For more 3Doodler® products, go to nascoeducation.com

3Doodler® Start+ Essentials Set

Gr. 2+ Use 3D printing pen while plugged in or charge it and doodle wirelessly for up to 1 hour. Teach design, building, construction, spatial understanding, and a variety of other skills in a fun, engaging way. No hot parts. Includes pen, 2 plastic packs, activity guide, micro USB charging cable, and free app. **CHOKING HAZARD (1)**. Not for under 3 yrs.

EL15551 — **\$51.95**

3Doodler Start+ Eco-Plastic Filament Packs

Gr. 1-8 Bring ideas to life by doodling 3D shapes and designs. With strands of colorful plastic and the compatible 3Doodler Start+ Pen, students can add dimension to any project with the low-heat, BPA-free and nontoxic plastics in each of these packs. One 6" strand will give over 35" of doodling as it melts. **CHOKING HAZARD (1)**. Not for under 3 yrs.

75 Strands

NE30218 Pack 1: Red, White, and Blue

NE30219 Pack 2: Orange, Yellow, and Green

Pack — \$14.50

250 Strands

NE30221 Fire and Ice Pack (Orange, Yellow, Pink, Light Blue, White)

NE30222 Primary Pow Pack (Red, Green, Blue, Black, Gray)

Pack — \$36.00



NE30218

NE30221

Green Screen Production Kit

Gr. K-12 Includes 360° rotating camera head, 10X digital zoom, 5 MP bendable gooseneck webcam, nonslip base, and built-in gooseneck microphone. Editing software with teleprompter, split screen, picture-in-picture, scroll text features, chroma-keying, and more. Import images, slides, or PDFs; add background, scripts and scroll copy; add date and time symbols; and show a news ticker. 9' x 60" green screen backdrop cloth. **EXCLUDED FROM DISCOUNTS**

EL15925 — **\$225.00**



BEST SELLER

FURNITURE

Before your students start exploring through hands-on lessons, it's important for your classroom to have the furniture and storage needed for experiments, demonstrations, safety, and more.



Gratnells Makerspace Cart
Side and back panels offer industry-standard holes and slots for a wide range of accessories. Runners allow easy and safe access to components. Steel frame. Heavy-duty lockable casters. Includes 12 shallow trays (16³/₁₆" x 12⁵/₁₆" x 3"), 3 deep trays (16³/₁₆" x 12⁵/₁₆" x 5⁷/₈"), 12 green mini bins, roll holder, 5 single hooks, and 5 double hooks.
Z51766(K) — \$1,340.00



EXCLUDED FROM DISCOUNTS

Gratnells Callero Plus Treble Carts
Premium, ultra heavy-duty carts transport your classroom equipment from place to place easily and securely. Adjustable StopSafe runner system ensures trays cannot be pulled fully out of the cart by accident, preventing spills. Tough, powder-coated metal frame offers wear and knock resistance. Features durable 3" casters and rounded ergonomic handles for easy movement. Includes 12 deep trays (16³/₁₆" x 12⁵/₁₆" x 5⁷/₈"). 16⁷/₈" x 40³/₁₆" x 41¹/₂".
(D) Royal Blue (E) Flame Red
Indicate color by letter code: Z51762(D)
Z51762 — \$925.00



EXCLUDED FROM DISCOUNTS

Gratnells Callero Plus Treble Carts
Runner system ensures trays can't be pulled fully out of the cart by accident. Adjustable runners accommodate various tray sizes. Rounded ergonomic handles. Powder-coated frame. Silver metal trim. 3" casters. Trays: 16³/₁₆" x 12⁵/₁₆". Includes 16 shallow (3") and 4 deep (5⁷/₈") trays. 16⁷/₈" x 40³/₁₆" x 41¹/₂".
(D) Royal Blue
(E) Flame Red
(G) Jolly Lime
Indicate color by letter code: Z51764(D)
Z51764 — \$999.00



Maple veneers

Z51708



Solid oak

Z51718

Intermix Clover Leaf Mobile Table

Finished with a chemical-resistant, earth-friendly UV finish Almond clover leaf top is made of high-pressure laminate. 4" locking casters. 60"L x 60"W x 30"H.

Double-Sided Table with Double Door Cabinet. Two locking door cabinets are back to back. Each measures 15"D x 30"W x 25"H with an adjustable shelf.

Z51707 Solid Oak — \$1,653.15

Z51708 Maple Veneers — \$1,653.15

Table with Lazy Susan. Open cabinet measures 30"D x 30"W x 25"H.

Z51718 Solid Oak — \$1,297.80

Z51719 Maple Veneers — \$1,297.80



Hardwood Stools™

Eco-friendly parawood stools with rounded edges and horizontal connector struts. Seat: 13⁷/₈" dia. x 3/4" thick. 24"H.
Z46970 — \$135.00



PEPCO Activity Table with Black Solid Phenolic Top

Solid oak coated bases with 2 fixed casters and 2 steel guides. Remains stable at rest. The 12 cubbies (3 on each side) are 12" x 11" x 6". Table is 30" with a 48" dia. solid phenolic resin top (no particle board core). Impact, scratch, water, and chemical resistant.
Z42356 — \$1,349.99



Interior® Steel Shop Stools with Backrest

Heavy-duty stools will stand up to years of use in busy classrooms. Gray 18-gauge steel tubing frame with 14" dia. seat. Masonite seat won't warp, chip, or crack. 25"–33" seat height range. Features height-adjustable legs, footrest, and self-leveling steel glides. 300 lb. weight capacity. Set of 2.
NE40407 — \$274.54



Steel Stationary Stool

Large, heavy-gauge steel seat with tempered Masonite panel. All-welded, tubular-steel frame, channeled footrest, and no bolts. Gray color. 14" seat dia.
9715463 Seat height 18", without back — \$119.00
0900743 Seat height 24", without back — \$94.09
0900745 Seat height 30", without back — \$104.99



Find out how easy it is to connect your school's e-procurement system on nascoeducation.com

- Tables & Carts **296–297**
- Allied **298**
- Hann Manufacturing **299**
- Diversified Woodcrafts **300–302**
- Shelving & Carts **303**

NEW



Allied® Wood Science Tables with Chem K-12 Top

The most popular science, STEM, and makerspace tables for K-12 environments. Eco-friendly Parawood construction. Superior stability and wobble resistance, low-profile apron, protective rubber boots, steel corner brackets, and adjustable leveling glides. Tops and frames pre-assembled.

- NE30505 24" x 48" — \$465.00
- NE30506 24" x 54" — \$515.00
- NE30507 24" x 60" — \$530.00
- NE30508 30" x 60" — \$535.00
- NE30509 30" x 72" — \$580.00

Steel corner brackets



Wobble resistance



PROVIDES LARGE STORAGE CAPACITY, MOBILITY, AND DURABILITY

while supporting the ever-changing assortment of projects in STEAM and makerspace environments

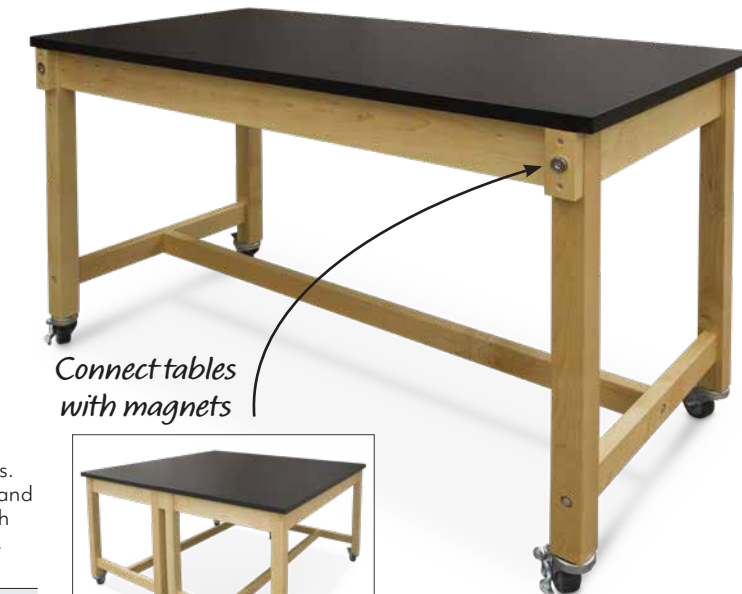

Connect tables with magnets

Mobile Project Collaboration Tables

Solid hard maple using thru-bolt reinforced mortise and tenon joints. 3" casters. Front casters are total-locking so the wheel will not turn and the caster itself will not rotate. Overall height: 36". Constructed with magnets so tables can be connected or disconnected without tools.

Product No.	Size	Top	Each
Z51231	30" x 60"	HPL	\$900.00
Z51232	30" x 60"	Epoxy Resin with Maple Base	\$1,700.00

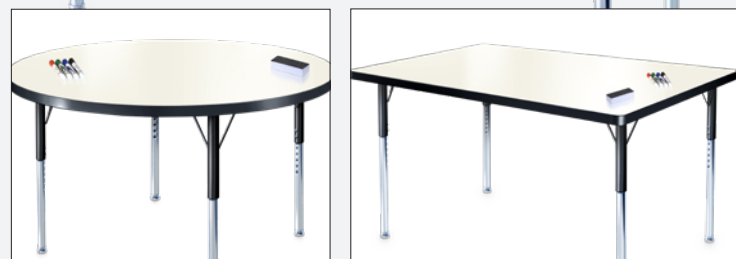

Classic Allied MarkerBoard™ Tables

Write and erase directly on laminate surface with gloss white, dry-erase finish. 45-lb. density, 1/4" thick high-pressure laminate top sealed with laminate backer sheet. Black vinyl T-molding finishes table edges. Tubular steel legs with wire bracing. Tables adjust in height from 20 1/2" to 29 1/2".

Product No.	Shape	Size	Each
*Z48004	Circle	48"	\$270.15
Z48005	Kidney	36" x 72"	\$365.00
*Z48006	Kidney	48" x 72"	\$412.00
Z48007	Rectangle	24" x 48"	\$236.90
*Z48008	Rectangle	24" x 60"	\$226.00
*Z48009	Rectangle	30" x 60"	\$269.25
Z48010	Rectangle	36" x 60"	\$300.00

*EXCLUDED FROM DISCOUNTS

Large Capacity Project Storage Cabinet

Extra depth and reinforced shelving to hold large tubs (up to 24"D). Shelves are supported on sides and at rear. Front edge is reinforced by solid hard maple nosing. Thick solid hard maple face and hard maple panels. Locking doors mounted on institutional hinges. 26"D x 48"W x 84"H.

Cabinet with Lower Garage Area. Center fixed shelf and 3 adjustable shelves in upper section. Lower section is intended to house a Project Support Cart (Z51235, below) or any mobile cabinet smaller than 40"W x 23"D x 31"H. **Z50643 — \$1,996.14**

Cabinet Without Garage Area. Full height shelving storage. Center fixed shelf and 4 adjustable shelves. ***Z51236 — \$1,996.00**

*EXCLUDED FROM DISCOUNTS



Great to use with MarkerBoard Tables above

EXPO® Low-Odor Dry-Erase Marker Set

Erases easily and completely. Bullet tip. Set of 4. 6100285 — \$7.05 12+ \$6.21

Mini Eraser

For dry-erase boards and tables. 2 1/4" x 3". TB18824 — \$0.80 10+ \$0.75



Mobile Project Support Cart with Lockable Doors

Features storage for tools and other project components and provides a great staging area for tubs and supplies so the amount of worktable surface available for project work is maximized. Made of a thick solid hard maple face frame and hard maple panels. The maple grain patterned HPL top measures 1/4" x 23" x 36" and has 3 mm PVC edge banding. Includes 12 3/4" W x 19" D x 3/4" H (I.D.) lockable storage drawers. Lower section includes two adjustable shelves and six tote trays. Moves on lockable 4 casters. 36"W x 23"D x 30"H. Cart fits into garage area of Large Capacity Project Storage Cabinet (Z50643, above). **Z51235 — \$1,584.00**

Choose the type of surface that fits your needs:

1 1/4" Plastic Laminate

A popular economical top for beginning level, non-severe situations

1 1/4" Chemguard

Resists common acids NOT suitable for open flames, molten metals, or excess heat or abrasives

1" Epoxy Resin

Premium-grade laboratory surface Impervious to normal laboratory chemicals and heat



Z10258

Science Tables

Apron-style wood science tables with solid oak frames and legs, 13-gauge steel corner braces, and rubber leg boots. Choose from 3 top choices: 1 1/4" plastic laminate, 1 1/4" Chemguard, and 1" epoxy resin. 30"H.

Product No.	Size	Surface Type	Each
Z10258	24" x 48"	Plastic Laminate	\$618.00
Z13916	24" x 48"	Chemguard	\$680.00
Z15587	24" x 48"	Epoxy Resin	\$999.99
Z10266	24" x 54"	Plastic Laminate	\$648.90
Z13917	24" x 54"	Chemguard	\$760.00
Z15586	24" x 54"	Epoxy Resin	\$1,030.00
Z15865	24" x 60"	Plastic Laminate	\$618.00
Z15867	24" x 60"	Chemguard	\$725.00
Z15871	24" x 60"	Epoxy Resin	\$999.99
Z10274	24" x 72"	Plastic Laminate	\$669.50
Z13918	24" x 72"	Chemguard	\$749.99
Z15585	24" x 72"	Epoxy Resin	\$1,199.99
Z10282	42" x 72"	Plastic Laminate	\$1,133.00
Z13919	42" x 72"	Chemguard	\$1,300.00
Z15584	42" x 72"	Epoxy Resin	\$1,899.99

Look for **FASTRAK** items
Our most popular items ship in 5 days or less.



Options for Student Science Tables (Allow 6-8 weeks for delivery)

Z10313 Add \$29.99 for leg braces to fit 24" x 48", 24" x 54", 24" x 60", and 24" x 72" tables. Recommended for any table 42" wide or greater, or when tables are moved frequently. Fit between legs at ends of table.

Z10314 Add \$32.90 for leg braces to fit 42" x 72" tables. Fit between legs at ends of table.

Z10315 Add \$89.10 for 36"H tables (standard tables are 30"H). Must be shipped truck.

Z10316 Add \$55.15 for AC duplex electrical receptacle.

For drawer options, contact Nasco Customer Care.

Ordering Instructions

1. Order tables by making the following choices: Table Size and Surface Type.
2. To order additional table options, see Table Options listing above.

EXAMPLE: To order a 24" x 48" table with plastic laminate top, leg braces, and duplex electrical receptacle, you'll need to order Z10258, Z10313, and Z10316.



Adjustable Metal Tables - ShopTop®

Can be adjusted in height from 25 1/2" H to 35 1/2" H. Legs and frame are made of 18-gauge steel. Steel base is finished with a gray baked enamel finish. 1,500-lb. static weight capacity without optional casters. 1,200-lb. static weight capacity with casters. Top surface: 1 3/4" x 30" D.

Z51698 60"W — \$1,235.85

Z51702 72"W — \$1,150.25

Z51706 96"W — \$1,449.85



Z51736

Forward Vision Tables on Casters

Legs and aprons are constructed of either maple veneer or solid red oak. 13-gauge steel corner braces. 2 1/4" square legs with 5/16" hanger bolts installed are attached to apron with included nuts and washers. Comes with locking casters. Top surface: 1 1/4" black plastic laminate. Overall size: 84" x 44" x 36".

Z51736 Red Oak — \$1,929.78

Z51737 Maple Veneer — \$1,983.78



A. ADA Mobile Lab Station

Chemical-resistant laminate. Stainless steel sink equipped with electric water pump and 2 water bottles. Water pump is operated with a toggle. 72"L x 24"D x 33"H.

Z15102 — \$3,120.00

B. Economy Mobile Lab Table

Storage for water bottles and 2 adjustable shelves behind sliding doors. Top is black 1 1/4" plastic laminate. Sink: 13"L x 15"W x 5"D. Table: 24"D x 48"W x 36" H. Oak with natural finish.

Z18488 — \$1,980.00



Combination Mirror/Markerboard

Solid oak frames and shatter-resistant acrylic mirror mounts easily on upright sets. 20 3/4" x 27 3/4".

Z11219 — \$173.04

C. Mobile Tote Tray Storage Cabinet

Oak veneers and solid oak. 4" locking swivel casters. Two lockable doors swing 270° and conceal 21 trays (19"L x 14 1/4"W x 3 1/2"H each). Plastic laminate top. 48"W x 24"D x 41 1/2"H.

Z40520 — \$2,224.25

D. Mobile Demo Table

Chemical-resistant, earth-friendly maple demo table with 500-lb. capacity. Unbreakable aluminum sliding door glides and lock, laminated top, inlet and duplex outlet, and 2 adjustable shelves. Top: 72"W x 24"D.

Z50293 — \$1,800.00

Can't find what you're looking for?

More styles, as well as 8- and 12-student work centers and tables, are available. Tell us what you need and we'll work to find options for your classroom.



Mobile Lab Cabinet
Solid oak and oak-veneered plywood. Adjustable shelf. Four heavy-duty swivel casters with brakes. Top is 1/4" black plastic laminate. 36"W x 24"D x 36"H.
Z16304 — \$950.00



Mobile Microscope Cabinet
Solid oak with clear UV finish and oak veneered swinging doors that lock. Removable wire dividers provide individual space for each microscope. Holds 24 standard classroom microscopes in 6 3/4" x 10" x 15 1/2" allotted spaces. 1/4" HP laminated top. 4" ball-bearing, locking, swivel casters. 48"W x 24"D x 40"H.
Z10256 — \$1,750.00



Z48014



Z48015

Wall-Mounted Storage Cabinets

Solid oak and oak veneer. Clear, chemical-resistant UV finish. Two adjustable shelves and lockable, hinged doors mounted with institutional hinges.

Product No.	Doors	Size	Price			
Z48014	Solid Oak	36" x 12" x 30"	\$648.90			
*Z48015	Oak-Framed Glazed	36" x 12" x 30"	\$881.68			

*EXCLUDED FROM DISCOUNTS



Mobile Balance Storage Cabinet
Safe, convenient way to store your various balances. Constructed of solid oak and oak-veneered plywood, with a clear finish. Supplied with four adjustable shelves to allow you to configure storage arrangement to maximize available space. Heavy-duty casters that swivel and have brakes. 48"L x 24"W x 40" H.
Z15103 — \$1,574.99



Scan to see the whole
Diversified Woodcrafts lineup
at nascoeducation.com

**OPENING OR RENOVATING
A SCIENCE LAB?**

Give us a call to learn how we can help



A. 10-Drawer Organizer
Molded stops on drawers prevent drawer from pushing through cart back. Each drawer holds up to 3 lbs. Includes 4 casters (2 locking). Silver frame measures 15 1/4"L x 13"W x 37 1/2"H. Drawer size: 14 1/4"L x 10 1/2"W x 2 3/4"H.
WA22879 — \$95.36

B. 3-Shelf Tuffy Cart™
Use indoors and out. Injection-molded thermoplastic will not warp or crack. Shelves have a nonslip pebbled surface and protective lip around edge. Large 4" ball-bearing swivel casters (2 locking). 18"D x 24"W x 34"H.
WA04058 — \$136.58



C. Heavy-Duty Utility Cart. Rounded corners protect walls and furniture. Nonmarring casters. Beige. Overall dimensions: 45 1/4" x 25 7/8" x 33 1/4".
9722594 — \$555.87

D. Stainless Steel Lab Cart
Shelves are electronically welded to legs. Padding under cart shelves deadens vibration and noise. Protective bumpers on legs and handles. 300-lb. capacity. Overall size: 16 1/4" x 27 1/2" x 32 1/8". Shelf size: 15 1/2" x 24". 3/2" swivel casters.
Z09515 — \$397.24



**Global Industrial™
Clear View Storage Cabinet**
Rugged construction will stand up to classroom use. Features impact-resistant acrylic windows and a pry-resistant 3-point key-locking system. Five adjustable, sag-resistant shelves hold up to 300 lbs each. 36" x 18" x 78".
NE40319 — \$924.32

Need help choosing?
Explore bestselling furniture created for educational environments



To download this free buying guide, visit resources.nascoeducation.com and search "furniture."

A

Adaptation 181-182
 AFNR 12-13
 Agar 52, 167
 Agarose 53

AIR

Pump 32
 Tubing 136

Airplanes 212
 Alcohol Burners/Stands 136
 Alcohol Prep Pads 45
 Alligator Clips 243
 Alternative Energy 225-229, 249, 279
 Aluminum Foil 114, 166
Anatomy 23-34, 38, 49, 73-77, 105
 Anemometers 187-188
 Animal Track Molds/Replicas 181-182, 202-203
 AP® Environmental 168-169, 175

APPLICATORS

Cotton 126
 Dropper 124-125, 166
 Magnetic 62
 Aprons 71, 74, 163
 Aquaponics 4-7, 10-12, 14-15, 172, 175
 Aquariums & Supplies 4, 6-8, 15-18, 114, 165
 Arthropoda, Preserved 67-68
 Ascaris, Preserved 67
 Astronomy 193, 204-209, 279
 Atom/Molecule Models 104-105
 Autopsy Investigation 65

B

BAGS

Lung Volume 33
 Reclosable 166
 Specimen 82

Balances/Scales 142-149, 151
 Barometers 185-186, 188
 Basic Buddy® Manikins 40
 Batteries and Accessories 166, 212, 235-236, 245, 284
 Beakers 118-119, 132, 166
 Beetles 78
 Bell in a Vacuum 141
 Bells 141
 Bingo Game, Space 205
 Biological Stains 52, 115

BIOLOGY 4-55

Biomimicry 21
 Biotechnology 53-55, 120
 Birds, Pigeon, Preserved 71
 Blades, Scalpel/Surgeon 80
 Blood Pressure Monitors 35
 Blood Typing Kits 45-46, 61
 BluTrack® 224
 Boards, Dry-Erase 156
 Boats, Weighing 145

BOOKS BY SUBJECT

Dissection 66, 70, 72-74
 Earth Science 193
 Forensics 59
 Physical Science 214

Botany 16-22
 Bottle Rocket Launcher 213

BOTTLES

Dropper 124
 Soda 213
 Spray 18, 165
 Boyle's Law Apparatus 230
 Bridges 280-282
 BRIGHT Kits 104
 Brushes, Lab 123
 Bug House/Viewers 97
 Building & Engineering 220, 278-283, 285, 288-89, 291
 Bulbs/holders 166, 244
 Bullfrogs, Preserved 70
 Bunsen Burners 136-137
 Burettes & Clamps 125, 130
 Burets 136-137

Butterflies 8
 Buzzer, Electric 246

C

CABINETS

Acid 117
 Corrosives 117
 Flammables 117
 Microscope 302
 Storage 301-302
 Calculators 154, 213, 268
 Calipers 152
 Calorimeters 233
 Cars 284

CARTS

Activity 303
 Laboratory 302, 303
 Light Fixtures 14
 Mobile 299, 303
 Service 303
 Storage 303
 Utility 303

Casting Plaster 181, 203
 Casting Resin 78
 Cat, Preserved 73
 Catapult 217
 Cells & Cell Processes 21, 46-50
 Centrifuge 139
 Centripetal Force 216
 Charles' Law 230

CHARTS/POSTERS

Anatomy 23, 24, 27, 29, 34
 Astronomy 204-205
 Birds 9
 Botanical 21
 Chemistry 102-103
 Clouds 191
 Dissection 74
 Earth Science 191, 194, 196-197
 Earthquakes 194
 Embryology 9
 Environmental Science 180
 Eye 27, 31
 Human Body 23-24, 27, 29
 Meteorology 191
 Moon 204
 Periodic Table 102-103
 Photosynthesis 21
 Planets 205
 Plants 21
 Volcanoes 194
 Weather 191
 X-Ray 23

Chemicals 114-116, 126, 135, 166
 Chemiluminescence 107

CHEMISTRY 47, 102-117, 169, 178, 225

Chickens/Incubation 9
 China Marking Pencil 157, 167
 Chromatography 46, 111-112, 167
 Circuit Boards 244, 247, 251, 270-271, 276
 Circuits 247-248, 250, 269, 271-272, 274-275
 Circulatory System 34
 Clam, Preserved 69

CLAMPS

Burette 125, 130-131
 Lever Knife Edge 220
 Pendulum 218
 Rod 130
 Test Tube 129

Cleaning Supplies 165
 Clinometers 213
 Clips, Alligator 243
 Clips, Fahnestock 243
 Clocks 242
 Clouds 191
 Coding 258-259, 261-262, 264-265, 267, 274-75
 Collision 220
 Collision Ball Apparatus 220
 Color Mixing/Theory 236-238
 Compasses 152, 195

Composting 179
 Conductivity 232-233, 251
 Conductometer, Heat 233
 Connector Cords 243
 Convection Apparatus 140, 191, 233
 Cords, Electrical 243
 Cork Stoppers 123
 Cotton Applicators 126
 Coverslips 98
 CPR Manikins & Accessories 39-40
 Crayfish, Preserved 66, 68, 77
 Crimping Tool 244
 Crucibles 126
 Crystals 16, 111, 200
 Cubelets® 262
 Cubes, Centimeter 145
 Culture Dishes/Tubes 127-128, 166
 Cylinders 121-122, 132

D

Dash™ Robots 291
 Data Loggers 21, 133, 158
 Demonstration Tables 301
 Density 108, 190, 221, 231-232
 Dialysis Membrane Tubing 47
 Diffraction 237, 239
 Diffusion 46-47
 Digestive System 29
 Digital Microscopes 92-93
 Diseases, Spread of 50-51, 55
 Dissecto Flex-Pads/Pans 82-83
 Dishes, Culture 127, 166
 Dishes, Evaporating 126
 Dispensing Bottles 124

DISSECTION

Anatomy Mats/Charts 74
 Pans/Trays 82-83
 Supplies 79-83, 125, 160-164, 201

DISSECTION GUIDES/MANUALS

Ascaris 66
 Brain 66
 Cat 73
 Clam 66
 Crayfish 66
 Earthworm 66-67
 Eye 76
 Frog 66, 70
 Grasshopper 66
 Heart 76
 Kidney 76
 Mammal Organs 75-76
 Mink 72
 Perch 66, 68
 Pig 74
 Sea Star (Starfish) 66
 Worm 66-67

Dissolved Oxygen Tester 174
 Distilled Water 115
 Distilling Apparatus 132
 DNA 42-44, 48, 53-55, 61, 202
 Dragster Kits & Accessories 284
 Drawing/Design 157, 166-167
 Dropper Applicators 124-125, 166
 Dry-Erase Boards/Supplies 156, 298

E

EARTH SCIENCE 168-203

Earthquakes 194
 Ecology 175, 180
 Ecosystems 180
 Egg Candler 9
 Electric Bell 247
 Electric Buzzer 246
 Electricity 37, 243, 246-248, 250-254, 270-271, 273-76
 Electromagnetism 251-252
 Electrophoresis 53-54
 Embryological Material 34
Energy 214, 225, 227-228, 242
 Energy Beads 227

ENGINES

Rocket 210

Stirling 214

Entomology 8, 67, 77-78

Environmental Science 21, 111, 133, 170, 172, 174, 176-183, 190

Erasers 298
 Erosion 192

EYE

Exam Chart 31
 Models 31
 Protectors (Glasses) 82, 160
 Wash Stations 164

EZ-Robot 266

F

Fast Plants® 16, 18
 Fetal Pigs, Preserved 74
 Field Identification Grid 182
 Filters, Aquarium 6, 114
 Filters, Paper 127
 Fingerprinting 57, 59, 61-62
 Fire Syringe 230
 First Aid Supplies 164

FISH

Perch, Preserved 66, 68
 Shark, Preserved 69
 Skate, Preserved 69

Fish Supplies 6-7
 Flashlights 166, 235, 245
 Flasks 120
 Flower Models 20
 Food & Nutrition Teaching Aids 29, 112
Force & Motion 150, 213-224, 230, 258, 270, 279-280, 285, 288

FORCEPS

Chemical 129
 Dissecting 81
 Plastic 81
 Thumb 81

FORENSIC SCIENCE 45, 51, 56-63

Forks, Tuning 240
 Fossils 198, 202-203
 Free Fall Apparatus 220
 Friction 166, 215, 217, 253
 Frogs, Preserved 66, 70, 77-78
 Funnels 127

FURNITURE

Cabinets 299, 301-302
 Carts 296, 303
 Sinks 164
 Stools 297
 Tables 297-301

G

Gas Law Apparatus 230
 Gears 283, 288

GENERATORS

A/C 246
 Electrostatic 252
 Van de Graaff 252
 Vibration 241

Genetics 42-45, 48, 54-55, 104-105, 135
 Geology 189, 190, 192-193, 195-196, 198-199

GLASS

Cover 98
 Pulse 233

GLASSES

Eclipse 208
 3D 237
 Safety 82, 160, 201

Glassware 132
 Glo Germ™ 51
 Globes 193, 196-197, 204, 206

GLOVES

Disposable 82, 162
 Heat-Resistant 120
 Latex 82, 162
 Nitrile 82, 162
 Poly 82, 162

Glucose Test Strips 116

Goggles 160-161, 201
 Graduated Cylinders 121-122
 Graph Charts/Paper 157, 166-167
 Grasshopper, Preserved 67
 Gravel 6, 166
 Greenhouses 15, 17
 Gyroscopes 216

H

Hall's Car 215
 Hand Boiler 232
 Happy Atoms 105
Health Sciences 38-41
 Heart Models 29
 Heat Conduction Unit 233
 Hoberman Sphere™ 288
 Hoffman Electrolysis Apparatus 252
 Hooke's Law Apparatus 221
 Hot Plates 137-138
 Human Reproduction & Development Kit 34
 Human Skeletons 23-25
 Humectant Fluid 65
 Hydroponics 10-15, 179

I

Igneous Rock Collections 198
 Inclined Planes 215
 Incubators, Egg 9
 Incubators, Lab 140
 Independent Learner 245
 Index Cards 166
 Inertia 220
 Inflatable Lungs 32
 Injection Arm Simulator 38
 Inoculation Loops 52
 Insect Supplies/Collection 8, 78, 97
 Insects 8, 78
 Instant Snow 191
 Invertebrates, Preserved 67-69
 Iron Filings 167, 256

JARS

Evidence Collection 63
 Specimen 122
 Wide-Mouth Specimen 122

J

K

K'NEX® 282-283
 Keva® Blocks 280
 Kimwipes® 165
Kit Components 157, 166-167, 192, 245

KITS

Acids & Bases 109
 AIDS 51
 Air 177
 Alginate Worm Connections 107
 Alternative Energy 225-228, 249
 Anatomy 34, 47
 Astronomy 207
 Atoms 104-105
 Autopsy Investigation 65
 Aviation 212
 Bacteria 51-52, 177
 Biochemistry 112
 Biofuel/Biodiesel 228
 Biology 19, 65-66, 77
 Blood Typing 45-46, 61
 Bridges 280
 Buoyancy 214
 Car 215, 227, 284
 Cells 46-47, 49
 Chemiluminescence 107
 Chemistry 106-112, 123, 132
 Chromatography 111
 Circuits 247-249, 270, 273, 276
 Construction 280
 Crystals 111
 Dendrochronology 19
 Dissection 65-66, 76, 79, 183
 DNA 42-44, 54-55, 61, 104-105
 Earth Science 180, 192
 Ecology 175

Electricity 243, 247-248, 250-251, 253, 271
 Electromagnetism 251-252
 Elements 107-108
 Energy 216, 225, 227-228, 242, 249
 Engineering 280-281, 286
 Environmental Science 169, 172-175, 178
 Enzyme 112
 Fingerprinting 57, 61-62
 Food Science 112
 Force & Motion 213-217, 220, 222, 285
 Forensic Science 45, 56-61
 Fossils 202-203
 Friction 217, 253
 General Science 104, 110, 112, 179, 284
 Genetics 42-45, 48-50, 105
 Geology 192-193, 195
 Hydroponics 13
 K'NEX® 283
 Light 235-237
 Lungs 32-33
 Magnetism 254, 257
 Makerspace 292
 Measurement 145, 156
 Meiosis 50
 Microbiology 52
 Mineral Study 199
 Mitosis 50
 Molecular 43-44, 104
 Ocean Science 176, 190
 Optics 235-236
 Osmosis & Diffusion 46-47
 Owl Pellets 183
 pH Measurement/Indicator 110
 Photosynthesis 20-21
 Physical Science 47, 107, 227, 230, 278, 280, 282-284
 Physiology 37, 47, 110
 Plants 4-5, 13, 14, 16, 18-20, 44
 Pollution 175
 Protein Synthesis 42-43
 Pulleys 220
 Radiation 227
 Reflection/Refraction/Diffraction 237
 Respiration 20
 Robotics 227, 262-263, 266
 Rocketry 211-213
 Rocks & Minerals 193, 198-200
 Simple Machines 220, 222
 Simulated Smokers Lungs 32
 Simulated Urinalysis 110
 Snap Circuits® 249
 Soil 18, 168-170, 179, 192
 Solar 225-228
 Sound 240-241
 Spectroscopy 111
 Stream Erosion & Deposition 192
 Veterinary 79
 Volcano 193
 Wastewater Treatment 178
 Water 172-173, 175, 177-178, 189-190, 192
 Water Pollution 175, 178
 Water Test 172-173, 175
 Weather 188-189, 191

Knife Switches 244

L

LAB

Aprons 71, 74, 163
 Burners 136
 Coats 163
 Furniture 164, 297-298, 300-303
 Graduated Cylinders 121
 Stools 297

LAB SAFETY & SUPPLIES 37, 51, 54-55, 82, 91, 96, 98, 100, 112, 114, 116, 118-167, 242, 252, 298

Labeling Supplies 119, 157, 167
 Laboratory Tables 164, 297, 300-301
 Lamp Boards 244
 Lamprey, Preserved 68

LAMPS

Alcohol 17, 136
 Miniature 166, 244
 Replacement 166, 244

Landforms 190
 Laser Optics 236
 Laser Pointer 236
 Launch Pad 212
 Leads, Alligator 243
 Lenses 234, 235
 Light Box 23, 235
 Light Bulbs 166, 244
 Light Fixtures 14, 17
 Light, Study of 234-239
 Litmus Paper 167
 Loop-the-Loop Apparatus 218

LUNG
 Models 33-34
 Preserved 32, 75-76
 Volume Bags 33

M

Magnet Kits 254, 256-257
 Magnetic Field Demonstrator 257
 Magnetic Putty 255
 Magnetism 138, 167, 251-252, 254-257
 Magnifiers 97, 167
 Makerspace 292, 295
 Makey Makey™ 273
 Mallets 240
 Manikins, CPR 40

MAPS
 Topographic 195
 U.S.A. 197
 World 196-197

Markers 156, 298
 Mass Sets 144-145, 151, 221
 Matatabalab 258
 Measurement 21, 119, 122, 132-133, 142, 144-145, 150-155, 187, 195, 217, 219, 221
 Measuring Tape 152-153
 Media, Culture 52
 Melting Point Device 136
 Metamorphic Rock Collection 198-199
 Meteorology 186, 191

METERS
 Conductivity 251
 Digital 253
 Electric 253
 Light 239
 Light Intensity 239
 Lux 239
 Moisture 171
 pH 171
 Soil 171
 Sound 242
 Spectrometer 239
 Wind 187

Metersticks 153, 220
 Metric Weights 145, 151
 Microscope Cabinets 302
 Microscope Slides 63, 98-101
 Microscopes/Accessories 84-98, 100, 167, 245
 Mineral & Rock Collections 198-201
 Mink, Preserved 72
 Mirrors 234

MODELS
 Anatomy 25-26, 28-30, 34
 Animal Cell 49
 Animal Tracks 181, 203
 Astronomy 206
 Atom 104-105
 Brain 29-30
 Cell 49
 DNA 43-44
 Ear 31
 Eye 31
 Fetus 34
 Flower 20
 Geology 3, 190, 193-194
 Heart 29
 Human Torso 28
 Knee Joint 26
 Lungs 32-33
 Molecular 43-44, 104-105
 Muscle 26
 Plant 49

Reproductive System 34
 Rockets 211
 Shoulder 26
 Skeleton 23-25
 Skin 27
 Skull 30
 Solar System 193, 204-205
 Spinal Cord 26
 Structures 280-281
 Teeth 31
 Torso 28
 Weather 189

Moisture Meters 171
 Molds, Animal Track 181-182
 Molds, Fossil 202-203
 Molecular Models 42-44, 104-105
 Moon 204
 Mortars & Pestles 126
 Motion, Study of 167, 214-216, 218-223, 226
 Motors 246

MOUNTS
 Animal Kingdom 78
 Embedded 78
 Plant 21-22
 Plastic Embedded 78
 Specimen 78

Mouse, Preserved 71
 Multimeters 253

N

NASCOGuard® 65
 Nature Print® Paper 22
 Navigation 195
 Needles, Teasing 81
 Nematoda, Preserved 67
 Neodymium Magnets 255-256

NETS
 Aquatic 174
 Butterfly 8
 Insect 8
 NeuLog Sensors 21, 133, 158, 187
 Newton's Disc 237
 Newtonian Demonstrator 219
 Nutrition 112

O

Oceanography 176-177
 Octopus, Preserved 69
 Olympiad Kit 284
 Optical Bench Set 235
 Optics 96, 235-236
 Osmosis 46-47
 Overflow Can 232
 Owl Pellets 183
 Ozobot® Robot 264

P

Paleontology 202-203
 Pans, Dissection 82-83
PAPER
 Absorption 22
 Bibulous 100
 Blotting 22
 Chemical Test 111, 134-135
 Chromatography 111
 Filter 127
 Genetics Test 135
 Glucose Test 116
 Graph 157, 166-167
 Hydron 134
 Lens 100
 pH 134
 Test 111, 134-135
 Parafilm® 126
 Peat Pellets/Pots 18
 Pendulums 218
 Periodic Table of Elements 102-103
 Pestles & Mortars 126
 Petri Dishes 127-128, 166
pH TESTING
 Indicator Solution 109, 112, 114
 Indicators 110, 114, 116, 135

Meters 171
 Paper/Test Strips 134-135, 167
 Testers 134, 171

Photocell 228
 Photogate 219

PHYSICAL SCIENCE 107, 167, 210-257, 270, 280-284, 288, 291, 297

Physics 252
 Physiology 36-37, 49
 Pig, Preserved 65-66, 74, 77
 Pipette Fillers 125
 Pipettes & Accessories 54-55, 125, 166
 Planetarium Models 206
 Planets 205-207

PLANTS
 Aquaponic Systems 4-5, 7
 Aquatic/Terrestrial 18
 Growing Systems 11-13, 15-17, 21
 Hydroponic Systems 13
 Light Fixtures 16-17
 Mounts 22
 Pots 17-18
 Presses 22
 Stands 16
 Trays 17-18

Plasma Ball 247
 Plaster 181, 203
 Plate Tectonics 193-194
 Plates, Glass 201
 Plates, Streak 201
 Potato Clock 242
 Pots, Peat 18
 Pots, Plastic 17
 Potting Soil 18
 Powder, Fingerprint 62-63
 Power Supplies 239, 254
 Presentation Cameras 93, 157

PRESERVED MATERIAL

Ascaris 67
 Bullfrogs 70
 Cats 73
 Clam 69
 Coral 68
 Cow Organs 75-76
 Crayfish 66, 68
 Dogfish Shark 69
 Earthworms 66-67
 Fish 68
 Frogs 66, 70
 Grasshoppers 67
 Insects 67
 Lampreys 68
 Lungs 32
 Mammalian Organs 76
 Mice 71
 Mink 72
 Mount Specimens 78
 Mussels 69
 Octopus 69
 Perch 66, 68
 Pig 65, 74
 Pig Organs 75
 Pigeon 71
 Quahog 69
 Rabbit 72
 Rats 66, 71
 Roundworms 67
 Sandworm 67
 Sea Star (Starfish) 66
 Sea Urchin 68
 Shark 69
 Sheep Organs 76
 Skate 69
 Snake 67
 Sponge 66
 Squid 66, 69
 Sea Star (Starfish) 66, 69
 Turtle 71
 Zoology Survey Sets 66, 77

Preserving Fluid 65
 Printer, 3D 293
 Prisms 234
 Protractors 152
 Psychrometers 186

Pulleys 167, 215, 220-221, 283
 Pulse Glass 225-229
 Pump, Air 32

R

Rabbit, Preserved 72
RACKS
 Glassware 128
 Microcentrifuge 139
 Test Tube 123, 128, 139
 Thermometer 158
 Radiometer 225
 Rat, Preserved 66, 71
 Reflection 234-235, 238
 Refraction 235-236, 238
 Refractometer 135
 Remagnetizer 254

REPLICAS
 Fossils 202-203
 Track Molds, Animal 181
 Reproduction 34
 Resin 78
 Resonance Apparatus 240
 Respiratory System 32-34, 46
 Riker Mounts 21-22, 78
 Ring Stands 131
 Ripple Tank 241-242
 Robotics 216, 223, 227, 259-260, 262-263, 265-268, 270, 273-274, 278-279, 291
 Rock Hardness Scales 199
 Rocketry 210-212
 Rocks & Minerals 198-201
 Roundworms, Preserved 67
 Rubber Band Cannons 217
 Rulers 152-153

S

Safety Goggles 160-161, 201
 Samplers, Water 172
 Sand/Gravel/Bedding (Aquatic Plants) 6, 166-167
 Sandbox, Augmented Reality 189

SCALES
 Beam 142
 Digital 147-148
 Platform 147
 Spring 150

Scalpels 80-81
 Scat Replicas 182
 Scissors 80
 Sea Urchin, Preserved 68
 Second Law of Motion Apparatus 220
 Sedimentary Rock Collections 198
 Seeds/Seed Germination 17-18, 167
 Sensors 21, 133, 187
 Simple Machines 220, 222-223, 278-279, 283

SKELETONS (BONES)
 Animal Bites™ 182
 Elbow Joint 76
 Human Body 23-26
 Long Bone 76
 Storage 24
 Vertebral Column 26

Skulls, Human 30
SLIDES
 Cover Glass 98
 Glass 98
 Microscope 50, 63, 98-100
 Sticky Slides 98

Snake, Preserved 67
 Snap Circuits® 245, 248-249

SOIL
 Dirt 18, 170
 Experiments 16, 21, 168-170
 Potting 18
 Samples 170
 Testing Supplies 168-171

SOLAR
 Bag 226
 Beads 227
 Cars 227

Cells 225-226
 Energy 225-229
 Motor 226, 246
 Solar System 204-207
 Sound 141, 240-242

SPACE SCIENCE 184, 204-209, 211, 213

Spark Lighter 136
 Specimen Bags/Labels 82
 Specimen Mounts 78, 176
 Spectrometer 238-239
 Spectroscope 239
 Spectrum Tubes 239
 Speed Measuring Tools 214, 219
 Sphygmomanometers 35
 Spirometer 33
 Sponge 66
 Spot Plates 123
 Spray Bottles 18, 165
 Spring Scales 150
 Squid, Preserved 66, 69
 Stands, Ring 131
 Static Electricity 252-253

STEAM/STEM 258-295
 Stethoscopes 35
 Sticky Slides 98
 Stirling Engine 214
 Stirrers 138-139
 Stirring Rods 126
 Stools 297
 Stoppers 123
 Stopwatches 155

STORAGE
 Cabinets 302
 Carts 301, 303
 Chemical 117
 Containers 201, 303

Streak Plates 201
 Stream Table & Accessories 192
 Support Rings/Stands 131

T

Tables 117, 297, 298, 300, 301
 Tape 62, 119, 167, 270
 Tape Measures 152-153
 Teasing Needles 81
 Telescopes 205, 208

TEST PAPER
 Chemical 111, 115-116, 134-135, 172-173
 Genetics 135
 Glucose 116
 Oil 171
 Strips 134-135, 167, 172-173

Test Tube Clamps 129
 Test Tube Racks 123, 128, 139
 Test Tubes 123, 139

TESTERS
 Oxygen 174
 pH 135, 171
 Soil 134, 168-171
 Water 172-175

THERMOMETERS
 Digital 159
 Enviro-Safe® 158
 Galileo 185
 General 158-159, 167, 174, 186
 Immersion 158, 167
 Indoor/Outdoor 185-186
 Laboratory 158-159, 186
 Racks 158
 Weather 185-186
 3D Printer 293
 3Doodler® 294

TIMERS
 Acceleration 219
 Digital 155, 219
 Force & Motion 219
 Measurement 155
 Stopwatches 155
 Tirrill Burner 136
 Tongues 129

Topographic Maps 194-195
 Tracks, Animals 181

TRAYS
 Dissection 82-83
 Plant 17, 82

Trebuchet 217
 Tree Growth Kit 19
 Trundle Wheel 153

TUBING
 Bunsen Burner 136
 Dialysis 47
 Tuning Forks 240
 Turtle, Preserved 71

U

Ultrasonic Cleaner 165
 Urine Test Paper/Strips 135

V

Vacuum Chamber 141
 Vacuum Pump 141
 Van de Graaff Generator 252
 Venipuncture Arm Simulator 38
 Veterinary Science 39
 Volcanoes 193
 Volume Sets 119

W

Water Analysis 174
 Water Bath 140
 Water Testing 172-176
 Watershed 190
 Wave Demonstrators 240-241

WEATHER
 Charts 191
 Forecasting 185, 189
 Instruments 185-187, 213
 Kits 188
 Models 189-190
 Psychrometers 186
 Rain Gauges 186
 Resources 191
 Stations 184-185
 Vanes 187-188

Weighing Boats/Dishes 145
 Weights 142, 144-145, 151, 221
 Well Plates 123
 Wheel, Trundle 153
 Wind Energy 225
 Wind Turbine 225, 229
 Wire Strippers 244
 Wire, Electrical 114-115, 243
 Wisconsin Fast Plants® 16, 18
 Woodcrafts 280-281

WORMS
 Earthworm, Preserved 66-67
 Roundworm, Preserved 67
 Sandworm/Clam Worm 67

X

X-Rays 23

Z

Zoology Survey Sets 66, 77



Ordering is easy! We belong to a wide network of regional and national purchasing cooperatives and contracts.

Prepare for “oohs” and “aahs”

with the exclusive Nasco Rocketry Kit

Students will have a blast building their own rockets and exploring flight phases, propulsion, and more. And you'll get everything you need for 25 students plus digital guides.

Learn more on p. 213



**ONLY AT
NASCO**